



CUPERTINO



CUPERTINO CIVIC CENTER

MASTER PLAN DOCUMENT APPENDICES

JULY 2015

PERKINS
+ WILL

FINAL DRAFT

The Civic Center Master Plan (CCMP) Document Appendices accompanies the CCMP Document. The CCMP Document is a summary of the planning process that began in 2012 as the Civic Center Master Plan Framework study and culminated at a Civic Center Master Plan, developed as directed by the City Council on October 21st, 2014.

This Appendix is a comprehensive collection of surveys, analysis and findings from studies carried out through the Civic Center Master Planning process. These are documented here as the following memorandums and presentations.

Reference to the relevant appendix source has been noted throughout the Civic Center Master Plan (CCMP) Document to guide the reader to further detailed information.

APPENDICES

CHAPTER 03. CONTEXT

- A-01 Community Conversation Interviews Report (PDC, April 2014)
- A-02 Cupertino Stakeholder Meeting Presentation & Feedback (P+W & PDC, May 14, 2014)
- A-03 Community Workshop Presentation (P+W, July 30, 2014)
- A-04 MindMixer Update with Comments (PDC, August 18, 2014)
- A-05 Community Feedback Summary Presentation (P+W, August 18, 2014)
- A-06 Existing Transportation Condition Analysis (F+P, May 29, 2014)
- A-07 Infrastructure: Existing Conditions Summary Memo (BKF, May 13, 2014)
- A-08 Arborist Report (Deborah Ellis, MS., January 2, 2015)
- A-09 Cupertino City Hall Essential Services Facility Analysis (AKH, 2012)
- A-10 Cupertino City Hall: MEP Systems Alternatives Study (PAE, October 2, 2014)
- A-11 Cupertino City Hall Alternatives Study, Structural Evaluation (Tipping Structural, September 29, 2014)
- A-12 City Hall Alternatives Study (P+W, September 16, 2014)
- A-13 ADA Self Evaluation & Transition Plan (City of Cupertino, March, 2015)

CHAPTER 04. MASTER PLAN

- A-14 Civic Center Master Plan City Council Presentation (P+W, October 21, 2014)
- A-15 Civic Center Master Plan Scenarios (P+W, December 11, 2014)
- A-16 Cupertino City Hall Cost Estimates (TBD, June 15, 2015)
 - New City Hall 40,000 sf
 - New City Hall 35,000 sf
 - New City Hall 30,000 sf
- A-17 City Hall Parking Cost Estimate (TBD June 15, 2015)
- A-18 Library Expansion Cost Estimates (TBD February 12, 2015)
 - West Wing Expansion 100 seats
 - West Wing Expansion 130 seats
 - East Wing Expansion 100 seats
 - East Wing Expansion 130 seats
 - Courtyard Infill 130 seats
 - 'Perch' Addition 130 seats
- A-19 CCMP Added Surface Parking Cost Estimate (TBD, April 24, 2015)
- A-20 CCMP Sitework for City Hall (TBD, May 15, 2015)

CHAPTER 05. PATHS TO IMPLEMENTATION

- A-21 Cupertino Civic Center Funding Strategy Analysis (Seifel Consulting, June 23, 2015)

APPENDIX A - 01

Community Conversation Interviews Report (April 2014)

**Cupertino CCMP+Parking Project
Community Conversations Interviews Report
April 2014**

Introduction

The city of Cupertino has recently launched a process to redesign the Cupertino Civic Center with the goals of addressing needs of the community as they pertain to parking, the library, and enhancing civic life. Through this process, a new design for the Civic Center will be refined and confirmed, based on input from members of the community, a citizen stakeholder group, technical experts, and City Council. The initial stages of the community engagement strategy include seeking broad community to help envision the future of the Civic Center, via face to face Community Conversation Interviews, as well via an interactive website. Community members will have additional opportunities to inform the Envision Cupertino's Civic Center project during upcoming Community Workshops scheduled for July and September.

The purpose of this report is to describe and review the results of the initial community engagement phase, the Community Conversation Interviews. This strategy focuses on reaching out to the public for a diverse range of voices to help inform and shape a community vision for Cupertino's Civic Center.

Methodology: Community Conversation Interviews

Community Conversations are a flexible and consistent strategy for gathering people's values, thoughts, and ideas on an important topic. They are flexible in that they can take a variety of forms, including interviews, focus groups, and online discussions. They are consistent in that they follow a general protocol that includes a few broad questions that can be adapted to different contexts and modalities.

Community Conversation Interviews in Cupertino took place on Saturday, April 5, 2014 at the annual Earth Day event. One hundred forty attendees at the event were interviewed by public engagement consultants and interns with Public Dialogue Consortium (PDC), and architecture/design consultants with Perkins + Will. The goal was to engage community members to help envision the future of a vibrant Civic Center, as well as to set an appreciative and interactive tone for community involvement throughout the planning process.

Public Dialogue Consortium (PDC) developed a Community Conversations Protocol to elicit both broad and specific community input. Following a brief introduction, Earth Day attendees were asked the following questions:

1. What do you like most about the civic center as it is right now?
2. Looking to the future, how can the civic center be improved? What would help

make this area become a more vibrant and dynamic center for community life in Cupertino?

- a) When people come to the improved civic center, what should they see when they arrive? What should they feel? What should they experience? What would instill a sense of pride about the City of Cupertino?
 - b) One idea for an addition to the civic center is a Community Center building. Do you support that idea? What kinds of programs and events should it have? What kinds of people and groups would use it?
 - c) What do you think about a new Teen Center? Would that be desirable in this complex? Should it be specific to Teens or should it also have fitness center/programs for adults?
 - d) What kinds of performances or festivals should be accommodated in the outdoor space at the civic center? What kinds of people and groups would use it?
 - e) Do you use the Library Field? How could it be enhanced for increased community and civic use?
3. What are your thoughts about improving accessibility to the civic center? By car, bus, bike or walking?
 4. What suggestions do you have for solving current parking challenges and to accommodate the new uses that could be added? 4a) What do you think about a new parking structure, perhaps above ground or below?

The interview questions were followed by a few optional demographics questions. Interviewees were invited to stay engaged in the process by providing an e-mail address for receiving updates. Appendix A includes the Community Conversations Protocol.

Participant Demographics

The Community Conversation interviews engaged a total of 140 participants. Participants were asked to indicate their gender, age, ethnicity, and total amount of time residing in Cupertino. Of the total interviewed, 58 percent were female and 42 percent were male. Chart 1 shows the ages of those interviewed, indicating that those under 18 were well represented in comparison with city wide demographics, while those over 65 were under represented (likely due to the nature of the family friendly Earth Day event). Comparisons for other age groups are not available due to specific age groupings not matching up between the two groups. Information about Cupertino's demographics are taken from the 2010 U.S. Census Bureau Report.

Chart 1: Age Demographics

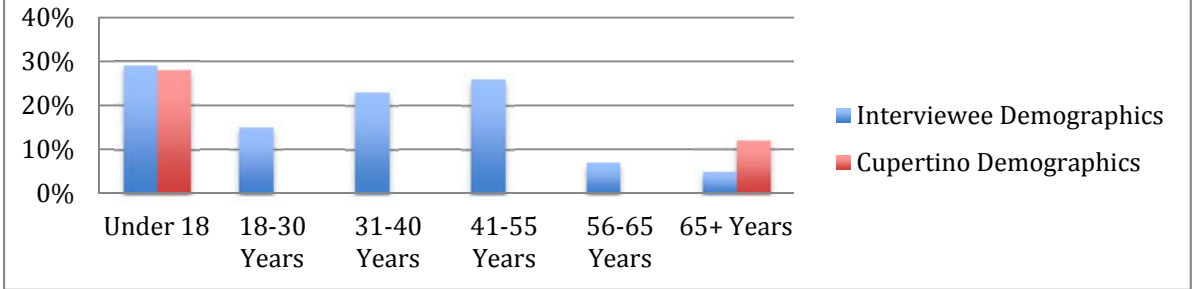

Chart 2 shows the ethnicity of those interviewed is well matched to the overall ethnic demographics of Cupertino.

Chart 2: Ethnicity Demographics

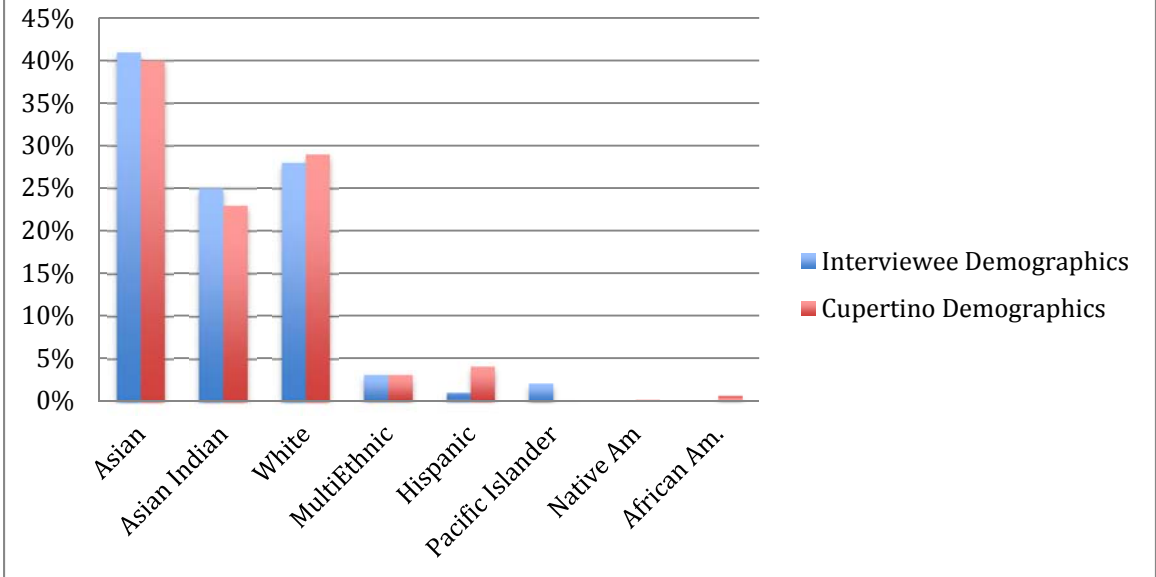
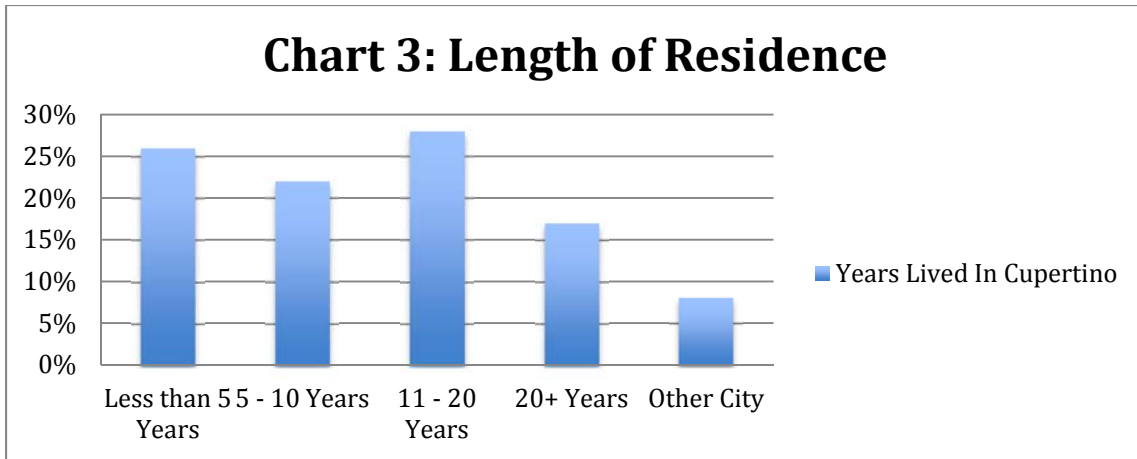

Chart 3 indicates the number of years interviewees have lived in Cupertino. As shown, interviewees represented a full range of residency from less than five years to over twenty years. Those who do not live in Cupertino were visiting from San Jose, Santa Clara, Saratoga, Sunnyvale, Mountain View and Milpitas.



Community Conversation Interview Themes

Responses to each of the interview questions are organized below into themes. Overall themes capture the most frequent responses given by community members, with specific ideas and quotes included for each theme.

1. *What do you like most about the civic center as it is right now?*

The comment that was most often given in response to this question was The Library. Residents enjoy the “*beautiful, “top notch” library, as a “nice facility” with “friendly service,” and a “great place to bring the kids.”* They appreciate “*all kinds of programs and activities*” the library offers, such as “*the teen center” “the conversation club,” and “book sales.”* They talked specifically about the “*selection of books,” “the fish, (my kids love the fish)” space to “sit and read quietly,” and the ability to use “the fast computers.”*”

Another common response was it is a good place to come because of the Open Space. Specific comments include, enjoying “*the wide openness,” of the “park-like” center to “relax and enjoy beautiful weather.”* Residents “*love the trees,” “the blooming flowers,” the plants and the roses, and that it is “peaceful.”* It is described as a “*good place for students to hang out,” as well as an “inviting community space,” with a “nice atmosphere,” good for “events and festivals.”*”

The Water Fountain and Statues are features also enjoyed by many residents interviewed. It is a “*good place for children,” and “for kids to fun around,” “gather and play.”*”

A final reoccurring theme in the responses of community members is the Accessibility of the Civic Center. Community members mention its “*convenience,” “walkability,” and that “everything is centralized.”*”

2. Looking to the future, how can the civic center be improved? What would help make this area become a more vibrant and dynamic center for community life in Cupertino? 2a) When people come to the improved civic center, what should they see when they arrive? What should they feel? What should they experience? What would instill a sense of pride about the City of Cupertino?

One of the most common suggestions from interviewees was to address Parking. One citizen suggested a “free shuttle around the city” to help with the problem.

Another common suggestion was to build a Playground or play structure for kids. One parent noted, “We come for the library then go somewhere else to play in the park. It would be great to have both here.” Other suggestions for “things for kids to do” include using the space outside the library for baseball, volleyball, basketball, tetherball, and even a jogging track.

Many people interviewed thought that having more Food options would be a great addition. Suggestions include increasing the variety of cafes, restaurants, food trucks, retail and food shops, and even adding a picnic area.

Community members frequently mentioned Landscaping, including “more green.” People suggested “more plants,” “grass or pavers rather than gravel,” planting more “trees for shade,” “less concrete and more grass,” and even adding “community gardens.”

Many people interviewed value the current atmosphere of the Civic Center and said to Keep It As Is. Comments included to “keep it relaxing” and “not overcrowded with too many events and programs.” Many enjoy how the space is “family oriented” and asked to “keep the open space and the family feel.” “It is relaxing and peaceful, a great place to go and study.”

While community members want to keep the current relaxing atmosphere, there is also expressed interest in adding More Events and Festivals “especially for kids and families.” Suggestions for this included adding outdoor movies (mentioned a few times), a performance auditorium, cultural events in the community hall, science themed activities, educational activities, events that introduce new technologies, live bands, arts and crafts activities, more book sales, and even an outdoor fire pit. Other things mentioned more than once by community members include adding solar panels to the buildings, along with adding cross walks and bike lanes.

2b) One idea for an addition to the civic center is a Community Center building. Do you support that idea? What kinds of programs and events should it have? What kinds of people and groups would use it?

Interestingly, community members talked more about programs and events for particular groups of people than a new Community Center building. For those who

did address this, responses were mostly unresponsive. For example, “Do we have space? Is that going to be a concern? This space is good as it is now, if you build too many buildings it won't look nice,” and “No need for a new building – we already have Quinlan and Memorial Park.” The one area where a new building was supported was in regards to a new Teen Center (see question 2C below).

Art and Music programs are frequently mentioned in response to the programming question asked here, as are Programs for Kids and Families. “Arts, crafts and activities for kids of all kinds,” “free painting areas for kids,” and “after school programs so kids can hang out and stay safe” and “places for kids to practice music and participate in an open mic” are all suggestions offered. A few people mentioned they would like music classes to be offered for their kids. Cultural Events and “programs that can bridge cultures” are also suggested. Specifics include showcasing specific cultures, their dance and music.

Several community members mentioned Networking Events “so you can get to know people and learn about the area.” A suggestion to “host family nights and days for families to get together and network with each other” captures this sentiment. Others mention hosting events that “bring the community together,” and even “showcase the talent of the community.”

Also mentioned are Fitness and Sports activities for kids and community members.

2c) What do you think about a new Teen Center? Would that be desirable in this complex? Should it be specific to Teens or should it also have fitness center/programs for adults?

Many community members asked said Yes to a Teen Center, a place for teens to socialize after school and on the weekends. Teens talked about having “a place to talk, hang out and eat,” with video games, movie nights, educational events and classes, sports activities, and even quiet places to read and study. Parents pointed out the “need for separate areas for teens studying and for those socializing,” and “making sure it stays a safe area where teens can be supervised.”

Some people pointed out there is already a teen area in the library and while it could be improved (better computers, books, and a quiet study area), it is better to have a community center with programs for families, kids, older adults so that “all residents feel welcome.”

2d) What kinds of performances or festivals should be accommodated in the outdoor space at the civic center? What kinds of people and groups would use it?

Frequently mentioned by those coming to enjoy the Earth Day event was to have more Festivals Like This. Family Oriented Educational Events are desired by many community members, as are Cultural Events “where people could learn about new cultures traditional attire, music, dance, and enjoy different foods.” Many people want

to see more live music events, as well as music and dance. One community member mentioned having a “silent disco” with headphones for people so they wouldn’t bother the neighbors. Outdoor Movie Nights was a popular suggestion, and food festivals, art shows, performances, holiday festivals, and ecological events were also mentioned more than once.

2e) Do you use the Library Field? How could it be enhanced for increased community and civic use?

Many people responded that they did not really use the field, but to keep it. Some people said to Keep It As Is, while others suggested Increasing the Sports Activities offered, such as adding a playground, an area for basketball, and a running trail or track around the field. A few people also mentioned planting more Trees for Shade, making it more family friendly.

3. What are your thoughts about improving accessibility to the civic center? By car, bus, bike or walking?

The most common answer to this question was to Increase Parking. While some people suggested “*improving public transportation*,” adding “*bike paths and bike parking*,” and adding crosswalks, most people pointed out that families drive their cars to the Civic Center. Some people mentioned they did not have a problem finding parking and walking a few blocks.

4. What suggestions do you have for solving current parking challenges and to accommodate the new uses that could be added? 4b) What do you think about a new parking structure, perhaps above ground or below?

While some people said they did not think there is a problem with parking, most people asked said there is a need for additional parking and that an Underground Parking Structure was the best solution for the Civic Center.

Conclusions & Next Steps

Will prepare with the final report that includes information from the online platform.

Appendix A

Cupertino Civic Center Master Plan Community Interviews: Protocol and Questions April 5, 2014

Sample Script to Set the Context for the Interview [Note: adapt to fit your own preferences and approach]

Hello, my name is _____. I work with (Perkins + Will, an urban design and architectural firm) (the Public Dialogue Consortium, a non-profit organization committed to improving the quality of communication in local communities). We have contracted with the City of Cupertino to help them develop a Civic Center Master Plan.

I appreciate the opportunity to talk with you today. I have a few simple questions that will guide our conversation. While you are talking I will be listening and taking some notes.

First, a little background to get us started. The Cupertino City Council has directed us to design a plan for the civic center, the area where we are standing right now, that focuses on "civic life." This means that they want this civic center to be a multifaceted place of government, culture, education, recreation, and celebration. So as you look around, we would like you to imagine how this area could be improved with new facilities, new programs, and flexible open space for civic, cultural and recreation events. The vision is to transform this area into a vibrant and dynamic center for community life in Cupertino. To accommodate more people coming here, the City Council also wants to improve parking.

We are in the early stages of considering different options for developing the civic center. Before going further, we want to hear from community members like you about your ideas for the civic center, what would you like see here. Your input is important. It will help shape the next stages of our planning, including our work with a local stakeholder group and two community workshops.

Do you have any questions about anything I've said so far?

Community Interview Questions

Now we would like to hear from you.

2. What do you like most about the civic center as it is right now?
 - a. Can you tell us more about why you like the things you mentioned?
3. Looking to the future, how can the civic center be improved? What would help make this area become a more vibrant and dynamic center for community life in Cupertino?

[Follow up questions, asked only after respondents answer the broad question above]

- a) When people come to the improved civic center, what should they see when they arrive? What should they feel? What should they experience? What would instill a sense of pride about the City of Cupertino?
 - b) One idea for an addition to the civic center is a Community Center building. Do you support that idea? What kinds of programs and events should it have? What kinds of people and groups would use it?
 - c) What do you think about a new Teen Center? Would that be desirable in this complex? Should it be specific to Teens or should it also have fitness center/programs for adults?
 - d) What kinds of performances or festivals should be accommodated in the outdoor space at the civic center? What kinds of people and groups would use it?
 - e) Do you use the Library Field? How could it be enhanced for increased community and civic use?
4. What are your thoughts about improving accessibility to the civic center? By car, bus, bike or walking?
 4. What suggestions do you have for solving current parking challenges and to accommodate the new uses that could be added?

[Follow up question, asked only after respondents answer the broad question above]

- a. What do you think about a new parking structure, perhaps above ground or below?

Demographic Information (voluntary)

1. Male ___ Female ___
2. How long have you lived in Cupertino? _____
 - If you are not a Cupertino resident, what City do you live in? _____
3. What age range do you fit into: ___below 18; ___18-30; ___31-40; ___41-55; ___55-65; ___above 65
4. What race or ethnicity would you say best describes you? _____
5. Your name: _____
6. Email address: _____

APPENDIX A - 02

Cupertino Stakeholder Memo (May 15, 2014)

This page intentionally left blank.

CIVIC CENTER MASTER PLAN

CIVIC LIFE

MASTER PLAN ALTERNATIVES

STAKEHOLDER MEETING



CITY OF CUPERTINO
MAY 14, 2014

FEHR + PEERS



WALKER
MAKING CONSENSUS

PDC Public Dialogue Consortium

PERKINS
+ WILL

AGENDA

May 14, 2014

PART A:

VISION, GOALS AND CHALLENGES (15 min)

STAKEHOLDER FEEDBACK (20 min)

PART B:

CONCEPT ALTERNATIVES PRESENTATION (15 min)

STAKEHOLDER BREAK-OUT SESSION (30 min)

STAKEHOLDER REPORT BACK (20 min)

CIVIC LIFE MASTER PLAN PROCESS + SCHEDULE

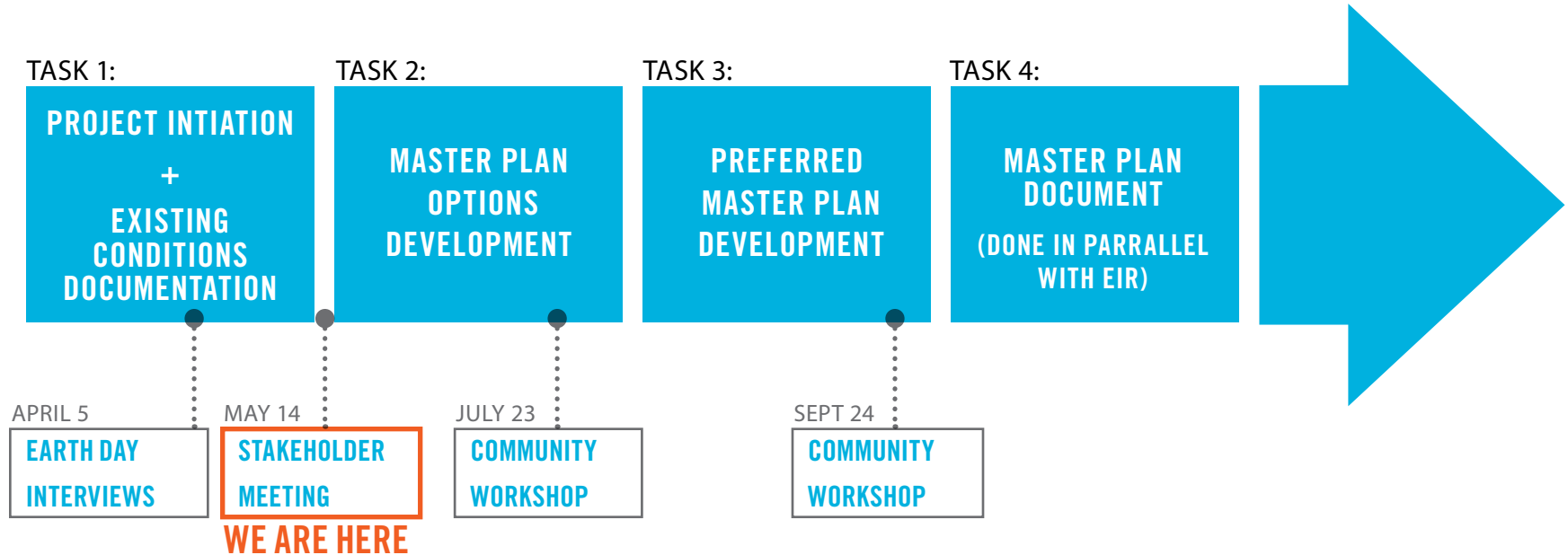

EXISTING CONDITION

PACIFICA AVE

LIBRARY FIELD

TORRE AVENUE

LIBRARY

MEMORIAL GROVE

LIBRARY PLAZA

CITY HALL

RODRIGUES AVE

SISTER CITY GROVE

SOUTH LOT

NORTH LOT

CREEK



CIVIC CENTER MASTER PLAN
GUIDING PRINCIPLES

CIVIC LIFE MASTER PLAN

IMPROVE EASE OF PARKING



CIVIC LIFE MASTER PLAN

CONSIDER COMMUNITY FACILITIES AND PROGRAMS



CIVIC LIFE MASTER PLAN

PROVIDE FLEXIBILITY OVER TIME



CIVIC LIFE MASTER PLAN

BE ENVIRONMENTALLY SUSTAINABLE



CIVIC LIFE MASTER PLAN

REPLACE CITY HALL FOR BETTER SERVICE, BETTER IDENTITY



CIVIC LIFE MASTER PLAN

ENHANCE MOBILITY CHOICES



CIVIC LIFE MASTER PLAN

IMPLEMENT WITH MINIMAL COST AND COMPLEXITY



CIVIC LIFE MASTER PLAN

BETTER SERVE CUPERTINO NEEDS TODAY & TOMORROW



CIVIC CENTER MASTER PLAN

IMAGINING WHAT COULD BE

CIVIC LIFE MASTER PLAN

CIVIC + COMMUNITY USE



CIVIC LIFE MASTER PLAN

CULTURAL + PERFORMING ARTS



CIVIC LIFE MASTER PLAN

RECREATION CENTER



STAND-ALONE TEEN CENTER



OUTDOOR MOVIE SCREENING





HOW DOES SOLVING THE
PARKING PROBLEM
 OF TODAY IMPACT THE FUTURE
 OF THE CIVIC CENTER DISTRICT



3 APPROACHES TO PARKING:

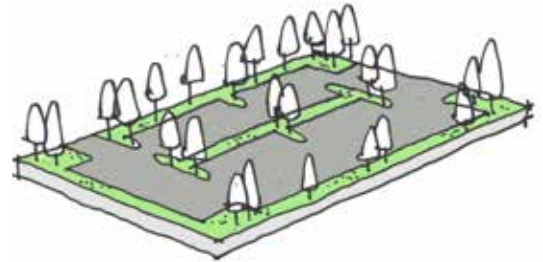
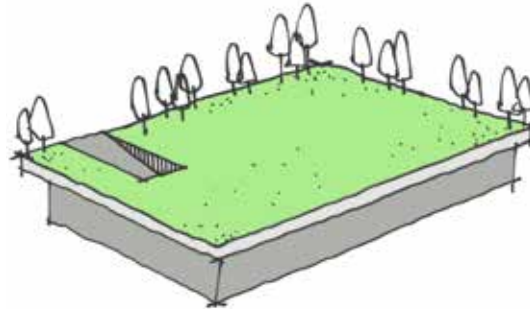
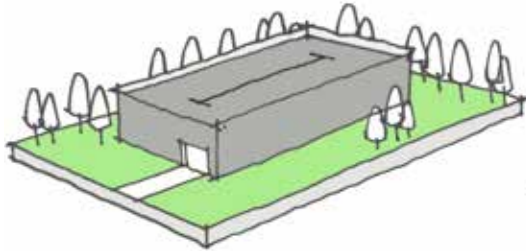

PARKING STRUCTURE



roll

roll

SURFACE LOT WITH BIO SWALES



INDOOR/OUTDOOR LANDSCAPE



SHADED AREAS



EXPANDED TRAIL CONNECTIONS



TORRE AVENUE STREET LIFE



WHAT ARE YOUR ASPIRATIONS FOR THE CIVIC CENTER?



CIVIC LIFE MASTER PLAN ALTERNATIVES

CIVIC LIFE MASTER PLAN

FRAMEWORKS

DECEMBER 2012



CIVIC NETWORK



CIVIC YOUTH



CIVIC LIFE

CIVIC LIFE MASTER PLAN

ALTERNATIVES APRIL 2014

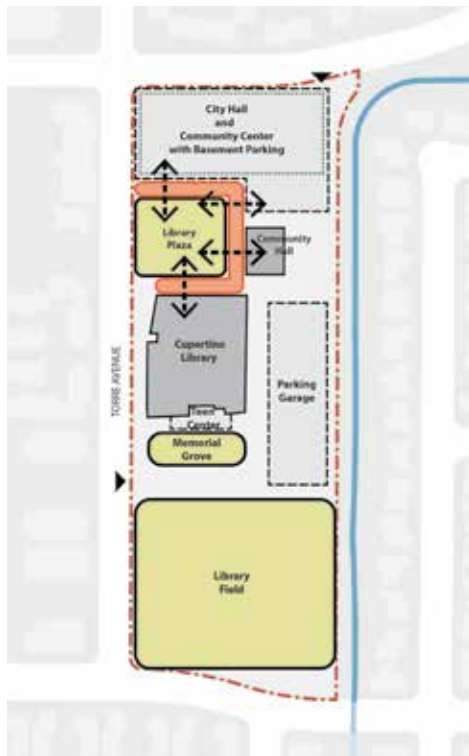

ON THE PLAZA

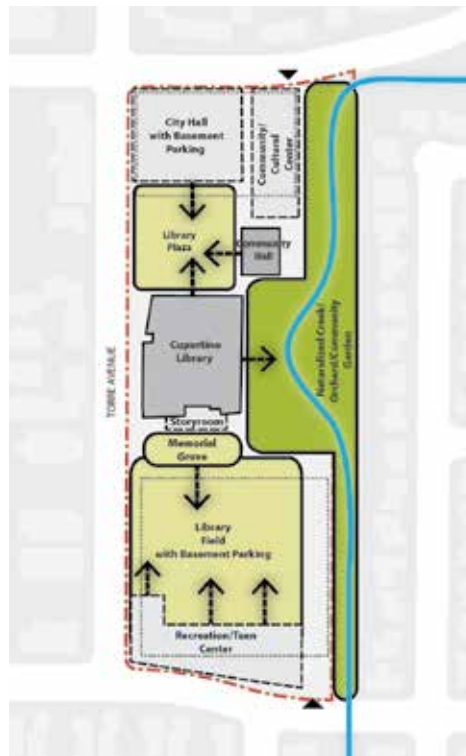

ON THE BLOCK

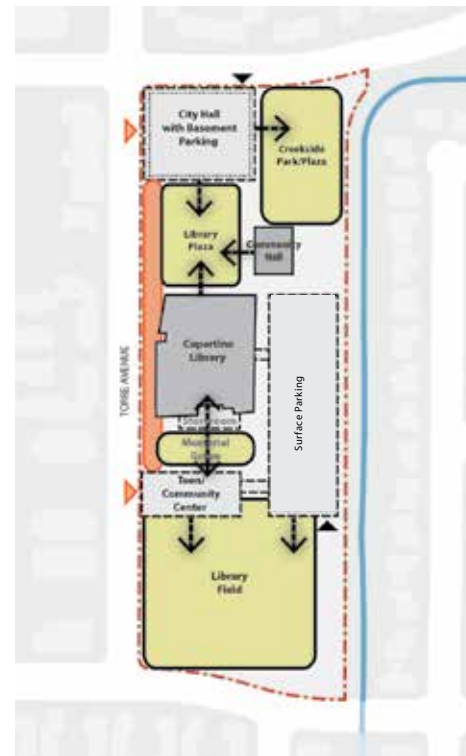

ON THE AVENUE

CIVIC LIFE MASTER PLAN

ALTERNATIVES APRIL 2014

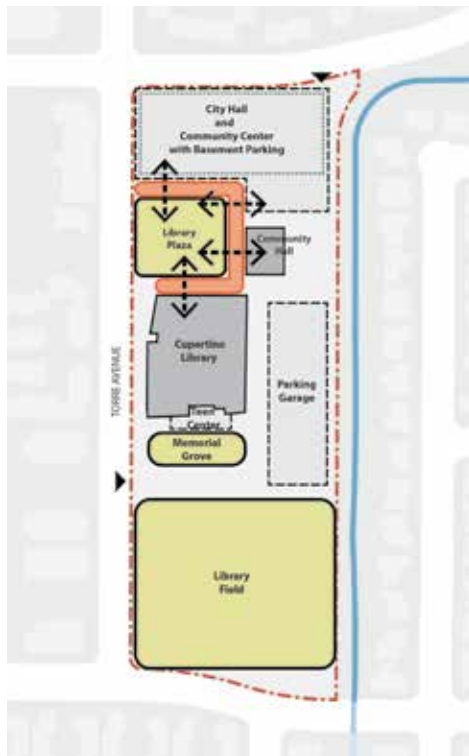

ON THE PLAZA

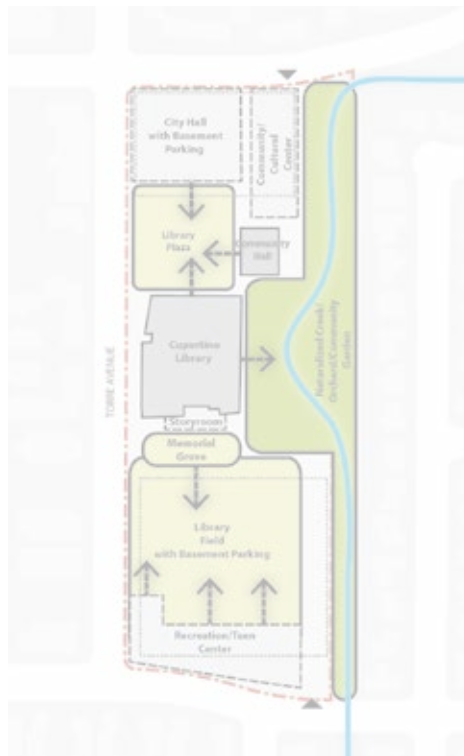

ON THE BLOCK

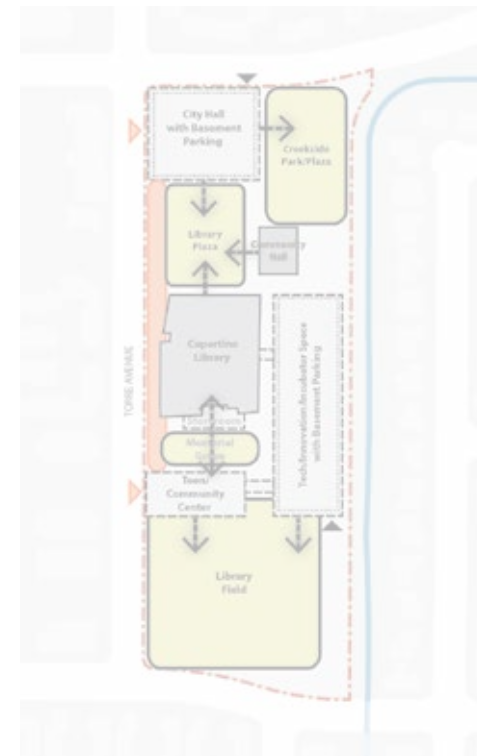

ON THE AVENUE

CIVIC LIFE MASTER PLAN

EXISTING CONDITION

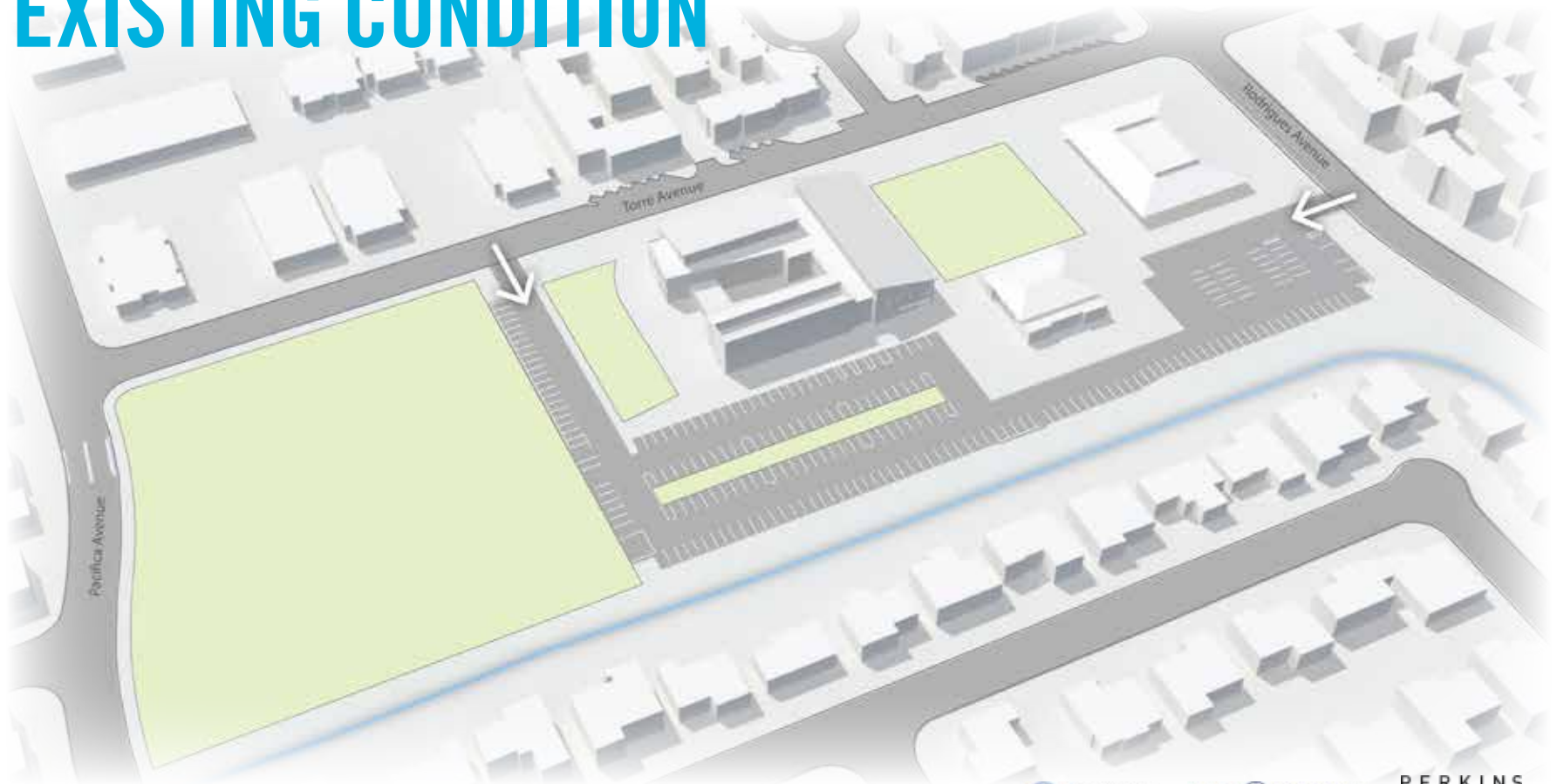

“ON THE PLAZA”

WITH PARKING STRUCTURE

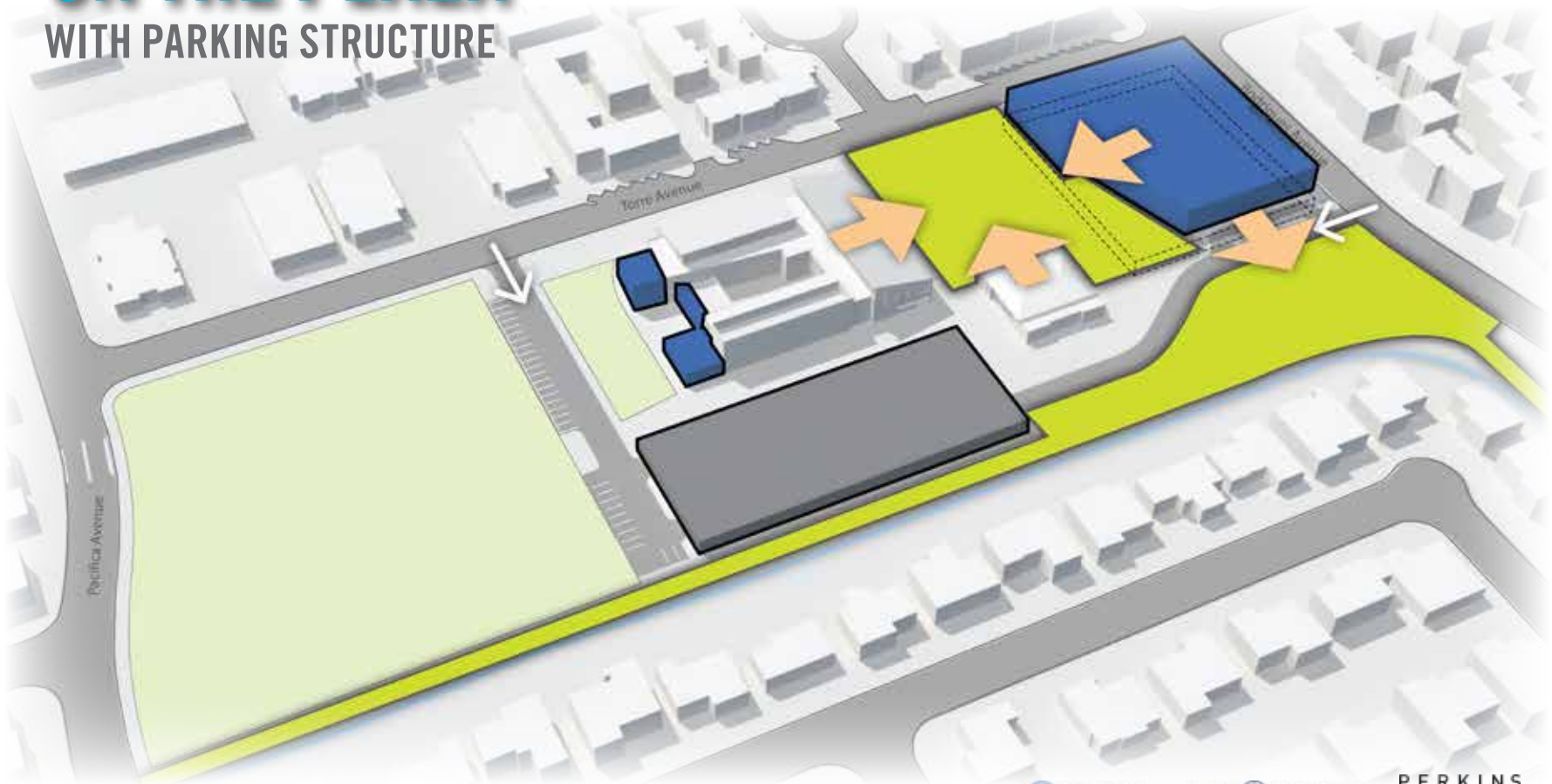

CIVIC LIFE MASTER PLAN

ALTERNATIVES APRIL 2014

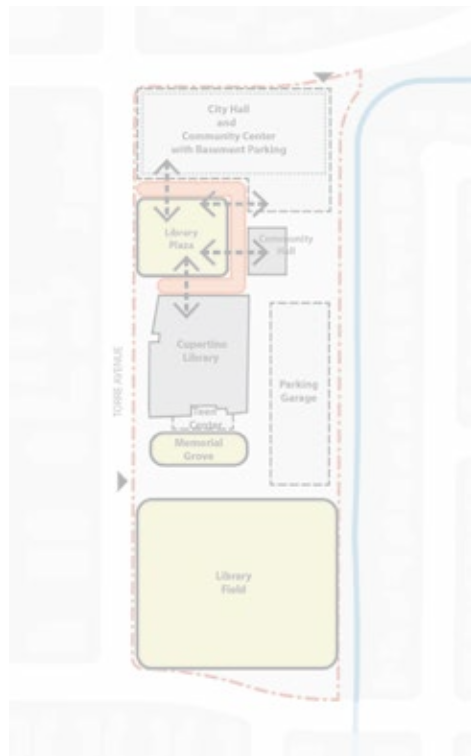

ON THE PLAZA

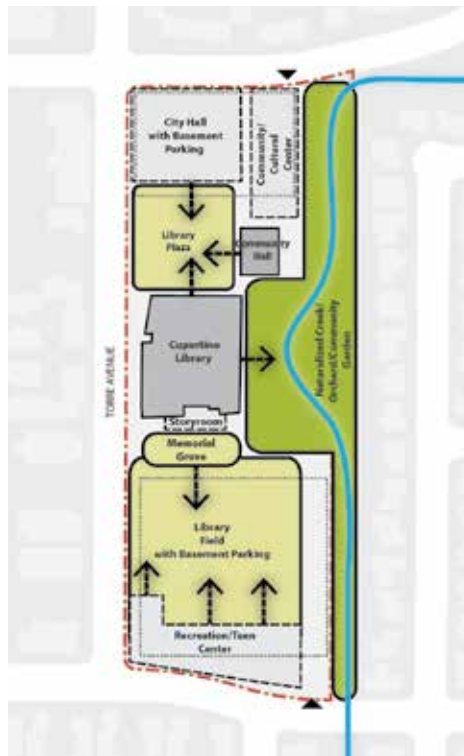

ON THE BLOCK

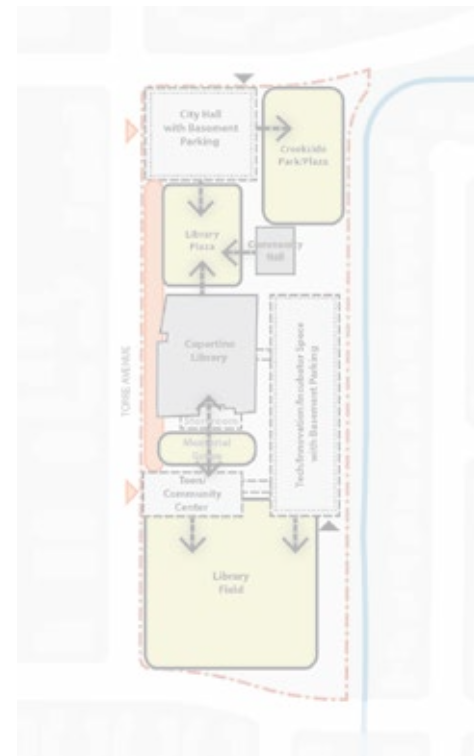

ON THE AVENUE

CIVIC LIFE MASTER PLAN

EXISTING CONDITION

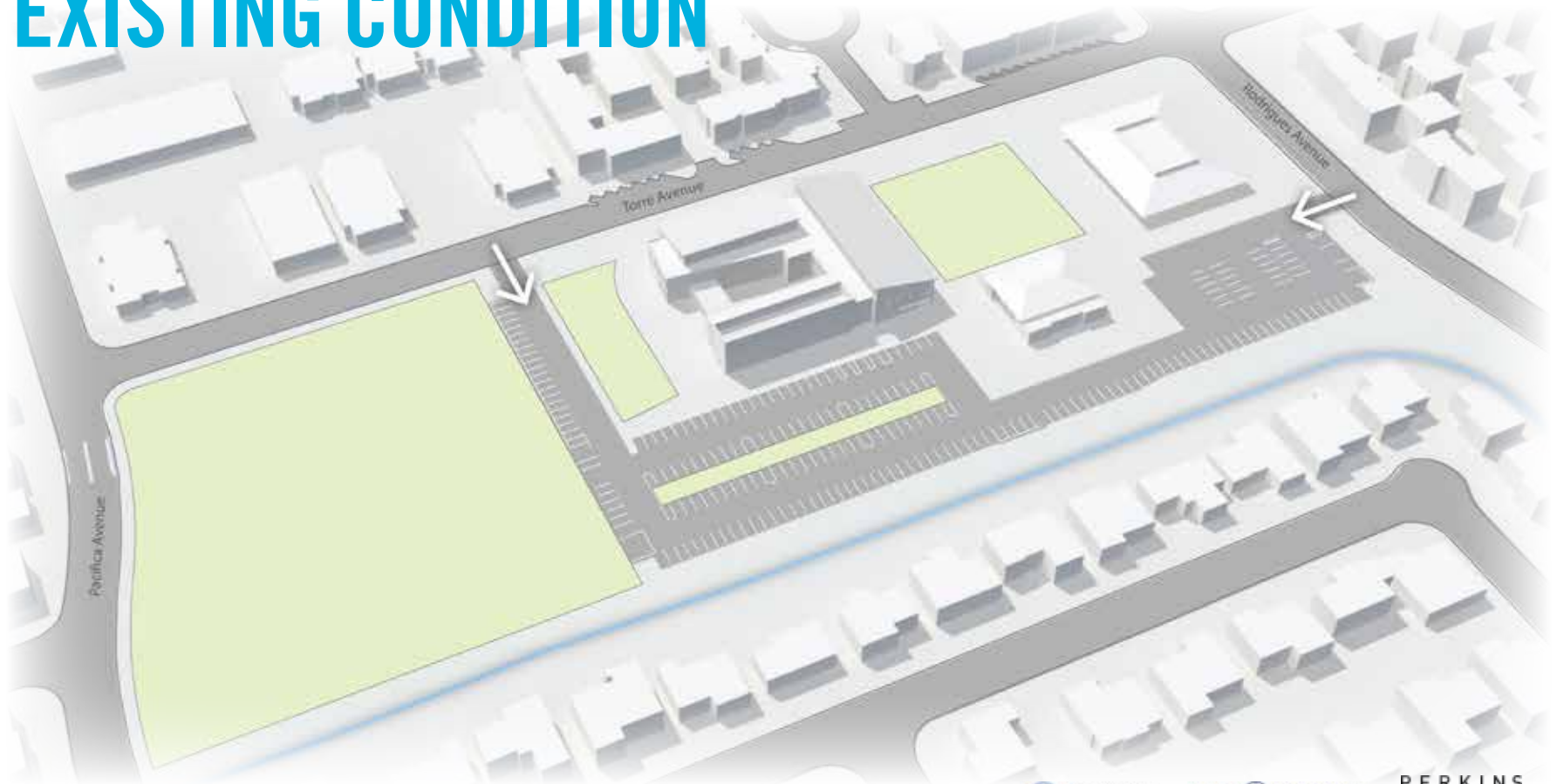

“ON THE BLOCK”

WITH UNDERGROUND PARKING



CIVIC LIFE MASTER PLAN

ALTERNATIVES APRIL 2014

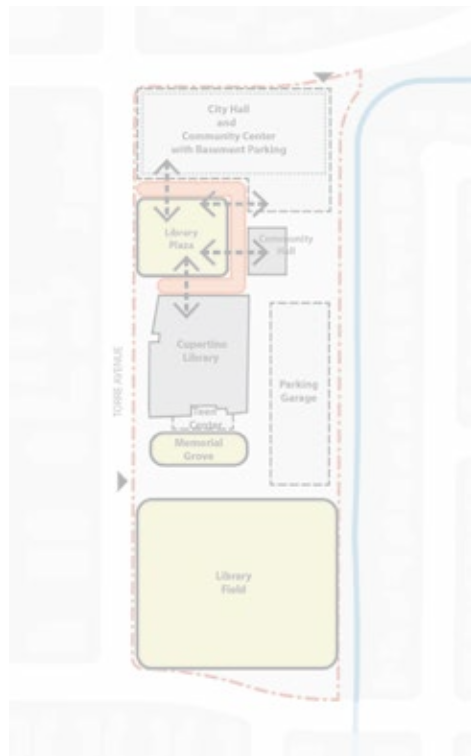

ON THE PLAZA

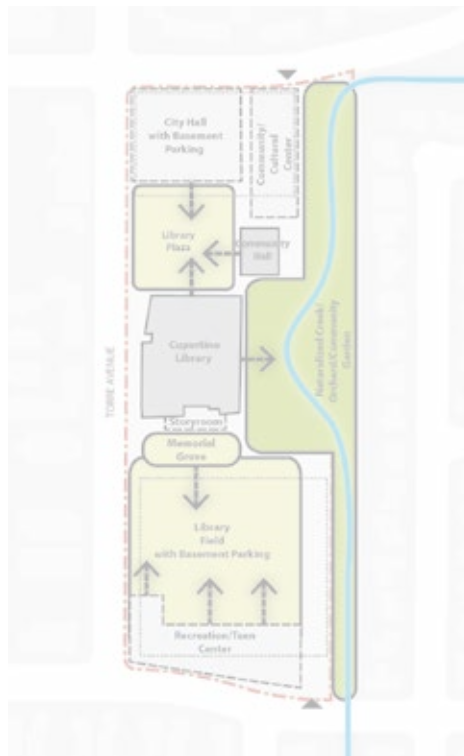

ON THE BLOCK

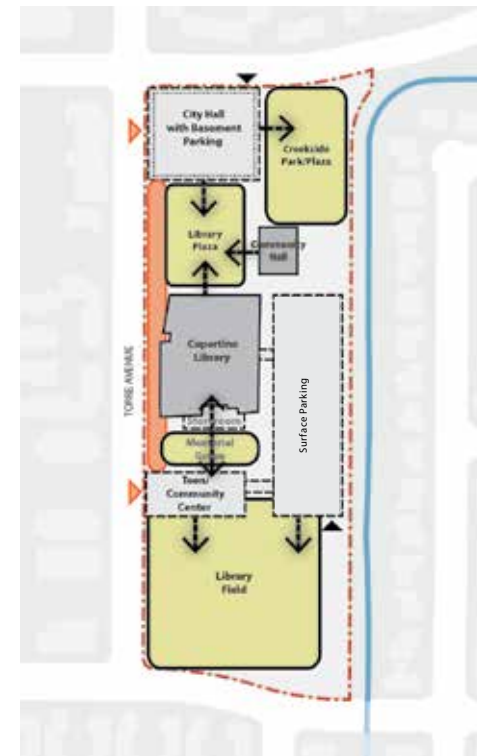

ON THE AVENUE

CIVIC LIFE MASTER PLAN

EXISTING CONDITION

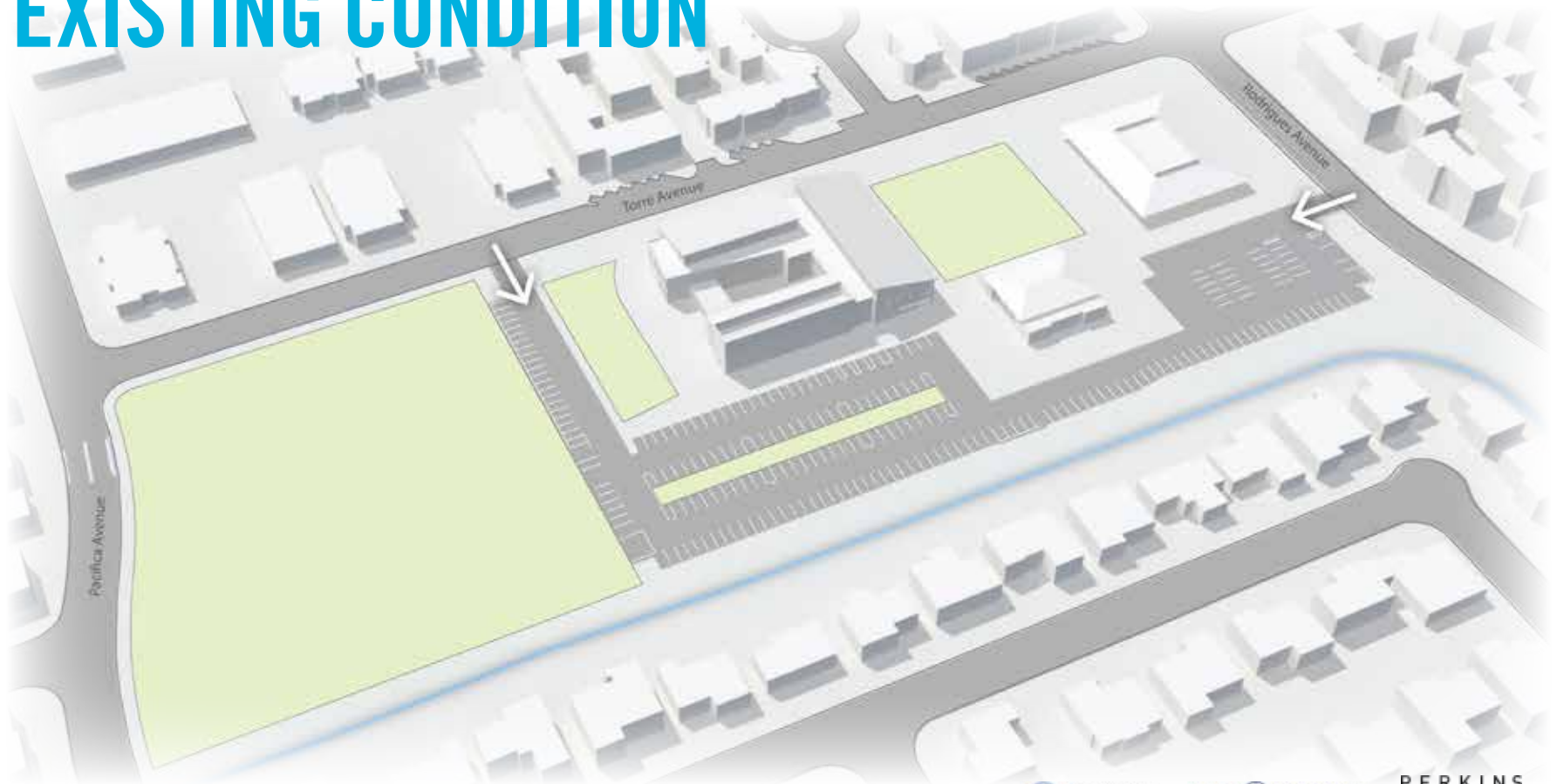

“ON THE AVENUE”

SURFACE LOT EXPANSION + MANAGEMENT

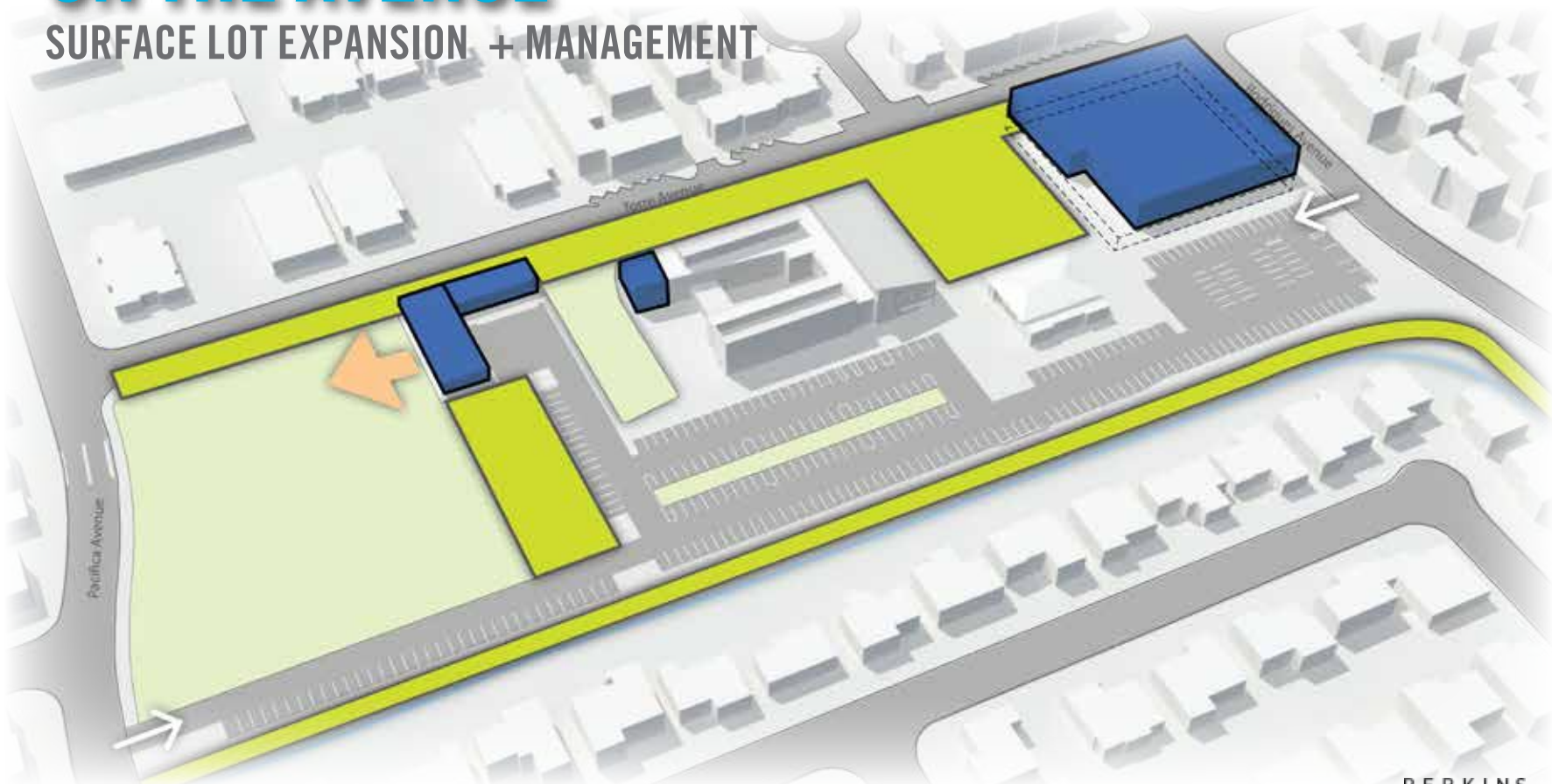

CIVIC CENTER MASTER PLAN
LIBRARY EXPANSION

CIVIC LIFE MASTER PLAN

LIBRARY EXPANSION

LIBRARY 2-WING EXPANSION

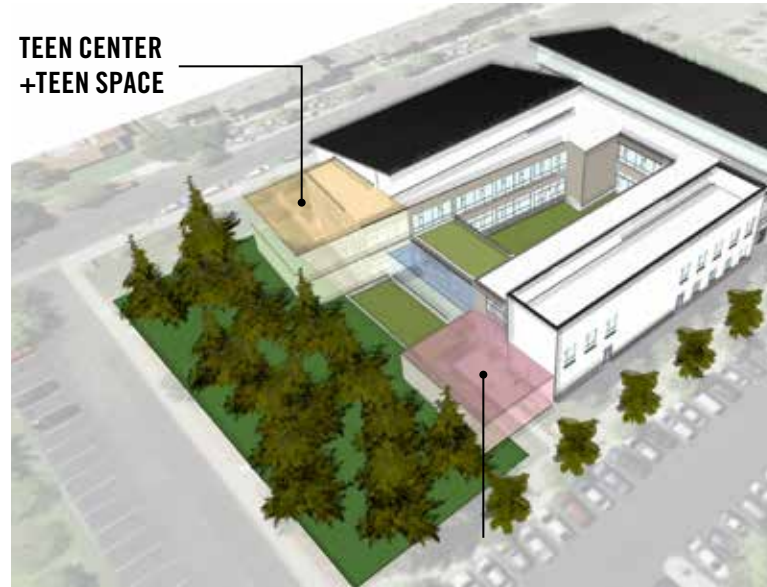

STAND-ALONE TEEN CENTER

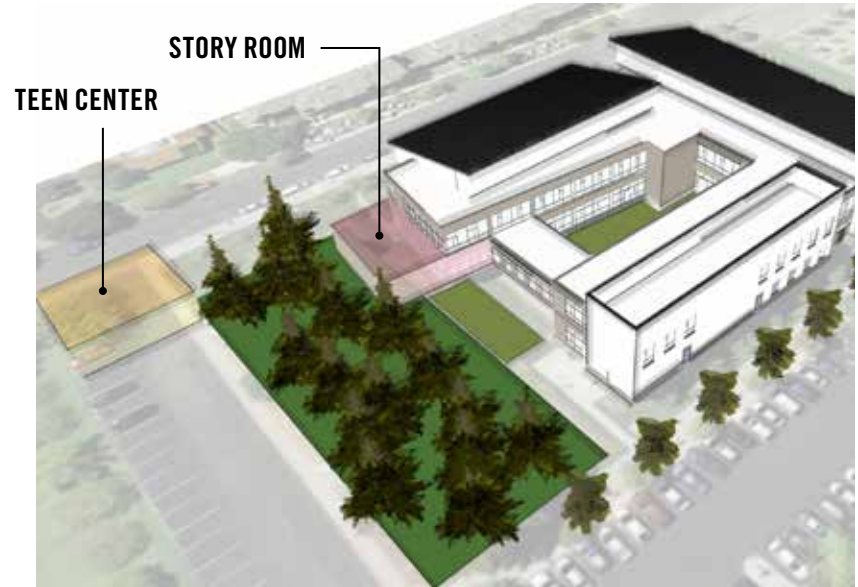

CIVIC LIFE MASTER PLAN LIBRARY EXPANSION



CIVIC LIFE MASTER PLAN

LIBRARY EXPANSION

STAND-ALONE TEEN CENTER

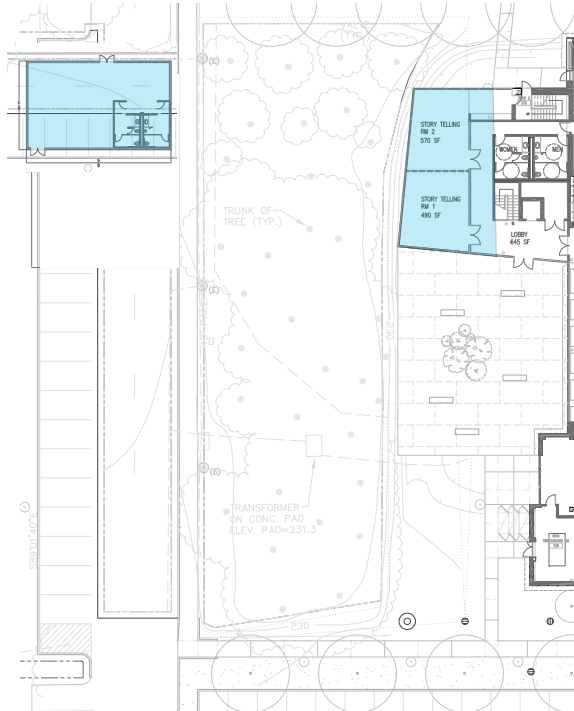

CIVIC LIFE MASTER PLAN

LIBRARY EXPANSION

EXISTING



CIVIC LIFE MASTER PLAN

LIBRARY EXPANSION

WITH STAND-ALONE TEEN CENTER



CIVIC LIFE MASTER PLAN

3 ALTERNATIVES



ON THE PLAZA



ON THE BLOCK



ON THE AVENUE

STAKEHOLDER BREAK-OUT SESSION
PLANNING GAME

CIVIC LIFE MASTER PLAN

HOW IT WORKS

THE PLAYING BOARD



PROGRAM PIECES

CIVIC LIFE MASTER PLAN

STAKEHOLDER FEEDBACK

STAKEHOLDER FEEDBACK ON THE PLAZA

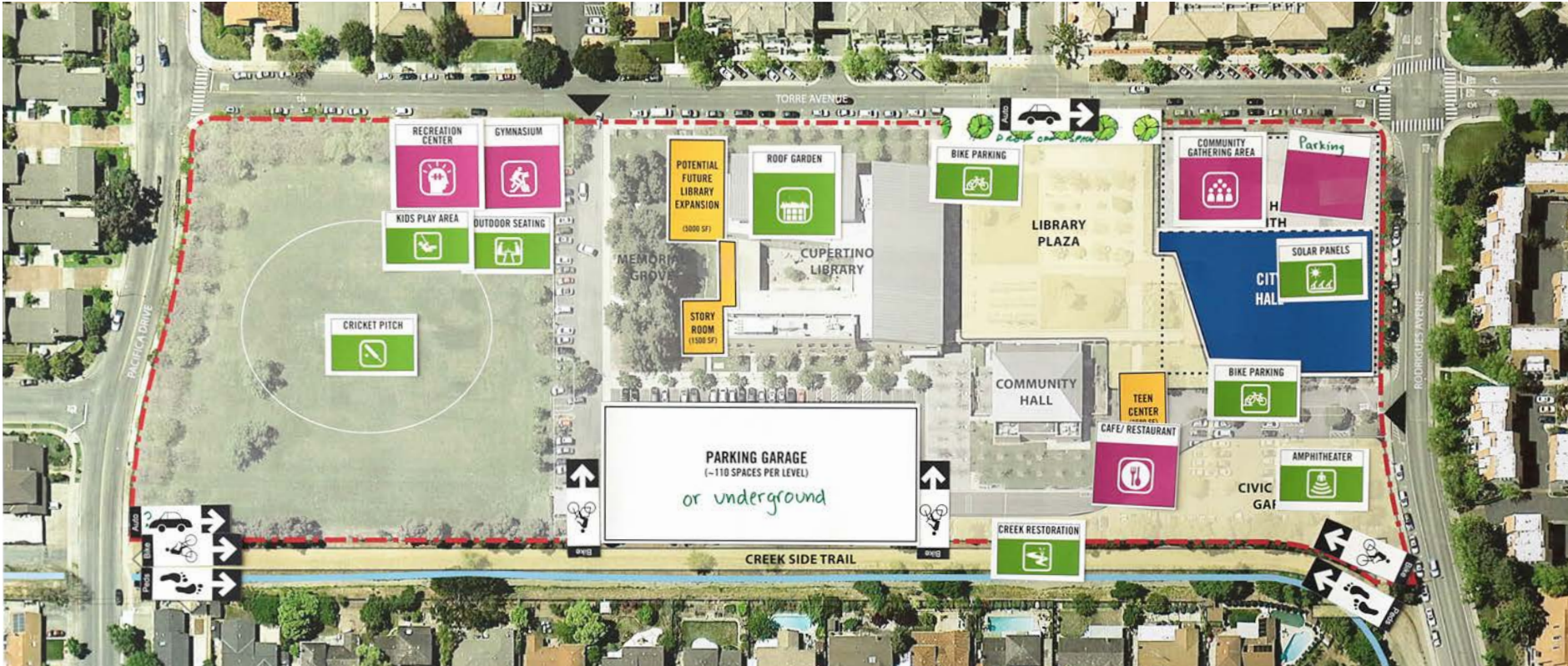

STAKEHOLDER FEEDBACK ON THE PLAZA

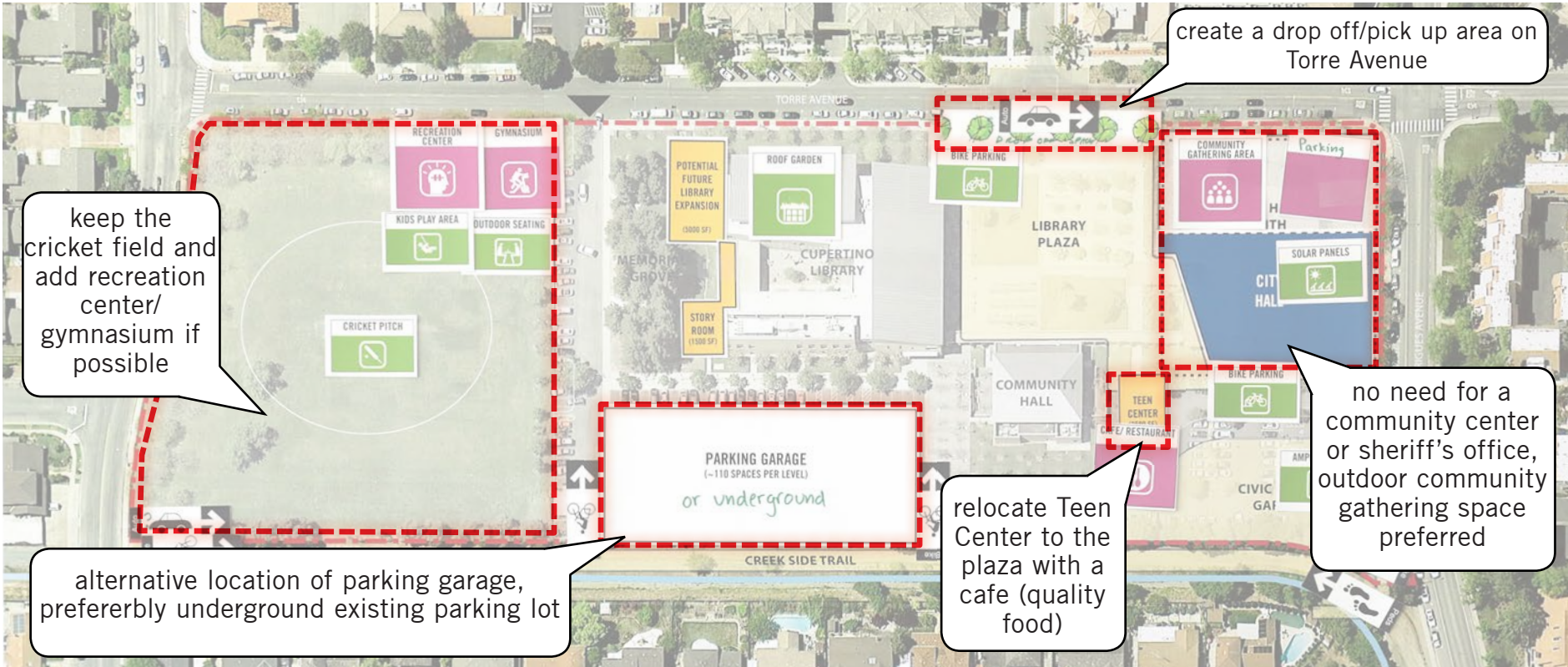

STAKEHOLDER FEEDBACK ON THE BLOCK



STAKEHOLDER FEEDBACK ON THE BLOCK

movie screening, picnic, gardens, community gathering space around library

add a food court near city hall & library plaza

underground parking with surface free for other use such as large gatherings, games, multicultural events, cricket pitch

community center available for more performances

sheriff's office as part of city hall expansion with underground parking

STAKEHOLDER FEEDBACK ON THE AVENUE



STAKEHOLDER FEEDBACK ON THE AVENUE

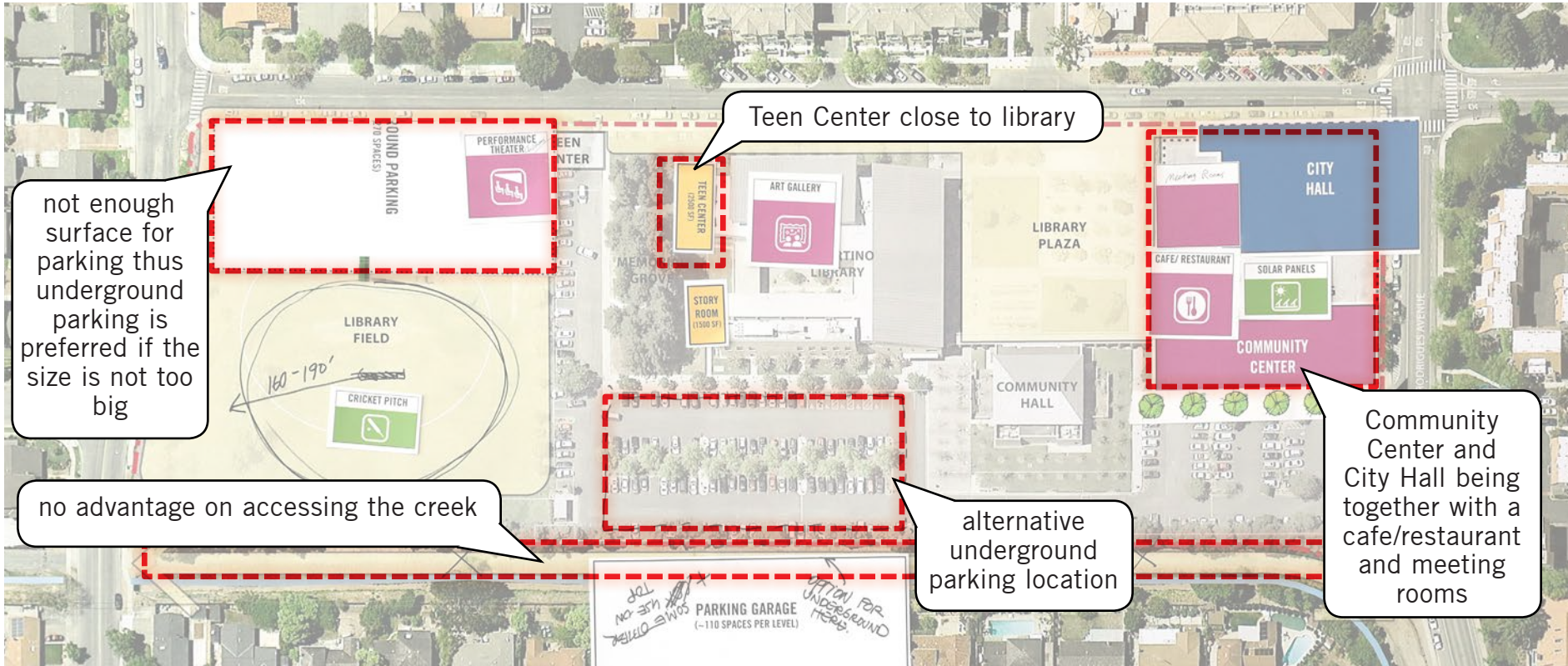

Imagine Cupertino Civic Center Stakeholder Meeting Notes
May 15, 2014

VISION REACTIONS

Preserve & Enhance Open Space

- Beautiful space, open space, trees
- Community space – indoor & outdoor gathering space
- Stay minimalist
- Keep and expand on open space in plaza
- Do not disturb existing layout too much, leave the field
- Improve creek trail, aware of ROI

Parking

- Put underground parking under existing structures
- Solar panels on parking roofs
- Address parking first!! Practicality and ease of use

Infrastructure

- Expand meeting rooms, programming space in library – look to the future
 - Big success of the civic center
- Upgrade, update city hall
- Love the idea of moving teen center to be more visible and incorporated into the civic center. Right now it is under the sports center and not visible. Teens use the library and would be more likely to go to a teen center if it was close.
- Plan for long term – what other elements will we want in the future?

GROUP WORK

On the Block Reactions to Plan

- Creek not a big draw, put in a creek trail and do not use the space for cars
- Put parking where not taking away from other elements and open space
- Should have adequate parking planning for future phases
- City Hall needs to be renovated soon, while we have the infusion of funds
- Story room needs a bigger name

On the Block Ideas

- Integrate and showcase technology
- Plaza/library open space can be an area for community gatherings like picnics and movie nights
- Sheriff's office: consider integration with city hall, need parking – put under the building, fits with civic services
- Roof garden on library and city hall with picnic areas
- Put solar panels on library
- Have performances in community hall
- Use the field for large gatherings and games, multicultural events, cricket pitch
- Plant trees everywhere
- Add a food court near city hall & library plaza

On the Block Priorities

- Underground parking w/surface free for other uses
- City hall with council & committee spaces
- Library expansion
- Sheriff's office as part of city hall expansion with underground parking
- Trees everywhere
- Community center available for performances
- Movie screenings, picnic, gardens, community gathering space around library

On the Avenue Reaction to Plan

- No real advantage to accessing the creek – issues of safety, kids crossing, parking
- Parking – only advantage is cost
- Teen center – priority of proximity to the library
- May need a survey for the teen center – it is really needed
- Why have a rec center here?
- Football size underground parking is too much. Is underground parking safe?

On the Avenue Ideas

- Children's theater
- Long term arrangement with Prometheus parking?
- Possible to expand civic site?
- Main barrier is not enough surface for parking
- Underground parking is favorable if it is safe
- Meeting rooms to accommodate 25-75 people, flexible space
- Turf not desirable, not suitable for cricket

On the Plaza Reactions to Plan

- Like the creekside trail idea – will neighbors complain?
- Will neighbors oppose above ground parking garage?
- Possible to put parking garage elsewhere?
- Better to have underground parking

On the Plaza Ideas

- Add parking access entry from Pacific ave
- Move the teen center to the plaza – near city hall or library, with a café
- Like next to city hall & proposed garden space by the creek
- Not sure if need rec center/gym, but put by field if so
- Put a kids play area in the field & outdoor seating
- Put amphitheater in garden space by city hall & creek
- Add a creekside trail for both pedestrians and bicycles
- Add underground parking at existing parking lot
- Add roof garden to any library additions
- Add solar panels to city hall

On the Plaza Priorities

- Make sure there is space for library expansion
- Move teen center to be on the plaza, not behind the library
- Add a café to the teen center
- Create bike paths and parking throughout civic center area
- Keep the field for cricket
- Expand parking at existing lot – underground, cost effective, considerate of neighbors
- No sheriff's office & parking – too much
- Do not need a community center – have Quinlan
- Add outdoor community gathering space by city hall
- Create a drop off/pick up area on Torre!*

GENERAL POINTS OF AGREEMENT

- Underground parking
- Expand the library
- Add a teen center
- Add a café (with quality food)

SOME AGREEMENT/DISAGREEMENT

- Upgrade city hall
- Creekside trail and restoration
- Sheriff's office and needed parking

This page intentionally left blank.

APPENDIX A - 03

Cupertino Workshop Presentation (P+W, July 30, 2014)

This page intentionally left blank.

CIVIC CENTER MASTER PLAN

CIVIC LIFE

MASTER PLAN ALTERNATIVES

COMMUNITY WORKSHOP



CITY OF CUPERTINO
JULY 30, 2014

FEHR & PEERS



WALKER
PARKING CONSULTANTS



PERKINS
+ WILL

AGENDA

July 30, 2014

INTRODUCTIONS & MEETING CONTEXT (10 min)

PRESENTATION: CONCEPTUAL MASTER PLAN OPTIONS (20 min)

QUESTIONS/ CLARIFICATION (15 min)

GROUP SESSIONS

BREAK OUT GROUP DISCUSSION (45 min)

BREAK OUT GROUP REPORT BACK (25 min)

CIVIC LIFE MASTER PLAN PROCESS TIMELINE



CIVIC LIFE MASTER PLAN CCMP CONTEXT

- Library Growth and Popularity
- Parking Challenges
- 2012 Civic Center Master Plan Study

OUR GOAL:
SOLVE THE PARKING PROBLEMS OF TODAY WITHOUT
COMPROMISING THE VISION AND OPPORTUNITIES FOR
THE FUTURE.

FRAMEWORK PLAN: DECEMBER 2012



CIVIC LIFE MASTER PLAN

GUIDING PRINCIPLES

Improve Ease of Parking

Consider Community Facilities and Programs

Provide Flexibility Over Time

Be Environmentally Sustainable

Replace City Hall for Better Service, Better Identity

Enhance Mobility Choices

Implement with Minimal Cost and Complexity

Better Serve Cupertino Needs Today & Tomorrow



CIVIC LIFE MASTER PLAN PUBLIC ENGAGEMENT



EARTH DAY EVENT

July 30, 2014



STAKEHOLDER MEETING

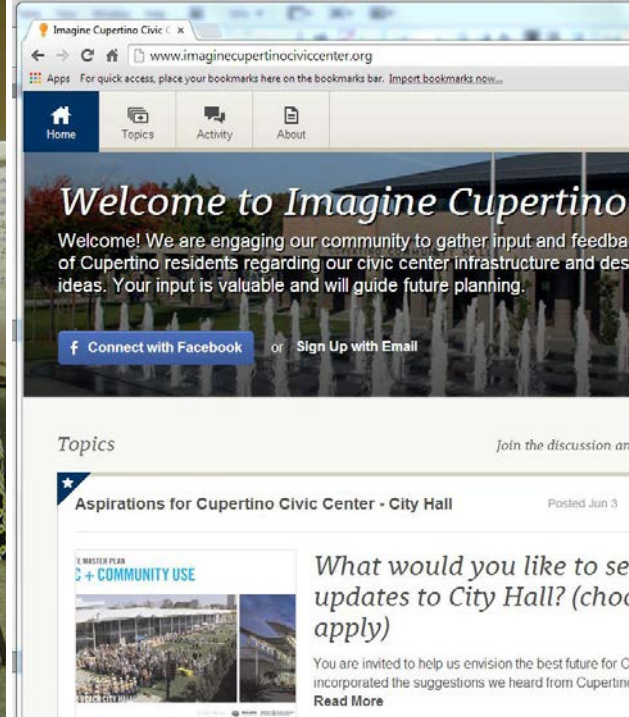

ONLINE FEEDBACK

CIVIC LIFE MASTER PLAN

WHAT WE'VE HEARD...

movie screening, picnic tables, garden, community gathering space around library

keep the cricket field and add recreation center/gymnasium if possible

underground parking and maintain cricket pitch

alternative location for parking garage, preferably underground below existing lot

no advantage to accessing the creek

add a food court near city hall & library plaza

make surface parking available for large gatherings, outdoor games, multicultural events

move council chamber to new City Hall & make Community Hall available for more performances and concerts

create a drop off/pick up area on Torre Avenue

add a food court near city hall & library plaza

no need for a community center or sheriff's office; outdoor community gathering space preferred

sheriff's office as part of city hall expansion with underground parking

Teen Center on the plaza with a cafe (quality food)

CIVIC CENTER MASTER PLAN

IMAGINING WHAT COULD BE

WHAT COULD BE? ... TONIGHT'S DISCUSSION

- LIBRARY EXPANSION
- TEEN CENTER
- CIVIC AND COMMUNITY USES
- SHERIFF'S OFFICE
- OPEN SPACE
- PARKING

CIVIC LIFE MASTER PLAN

LIBRARY EXPANSION

OPTION 1: LIBRARY 2-WING EXPANSION

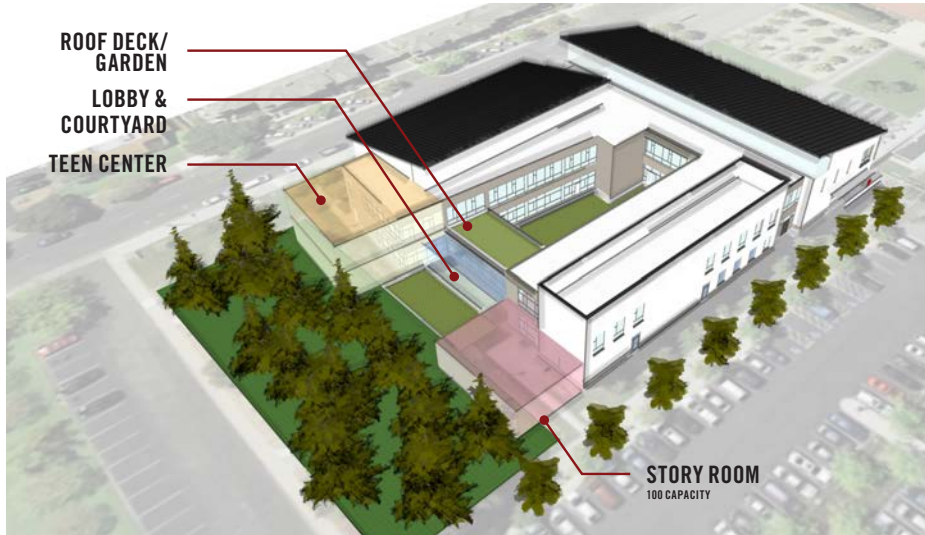

OPTION 2: STAND-ALONE TEEN CENTER

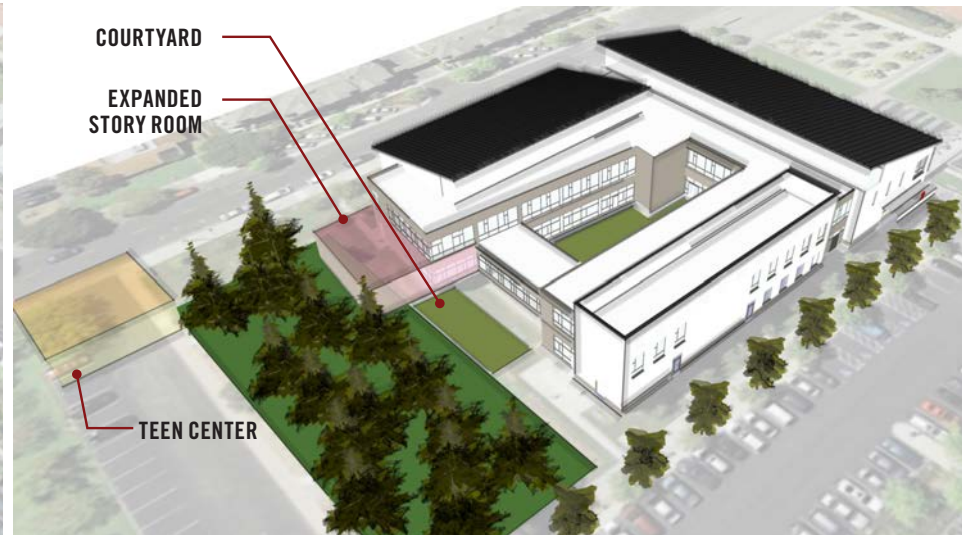

CIVIC LIFE MASTER PLAN

TEEN CENTER- ACADEMIC



CIVIC LIFE MASTER PLAN

TEEN CENTER- TECH/MEDIA



July 30, 2014

FEHR PEERS

WALKER
PARKING CONSULTANTS

PDC Public Dialogue
Consortium

PERKINS
+ WILL

CIVIC LIFE MASTER PLAN

TEEN CENTER- RECREATION



CIVIC LIFE MASTER PLAN

CITY HALL + COMMUNITY USE



CIVIC LIFE MASTER PLAN

SHERIFF'S OFFICE

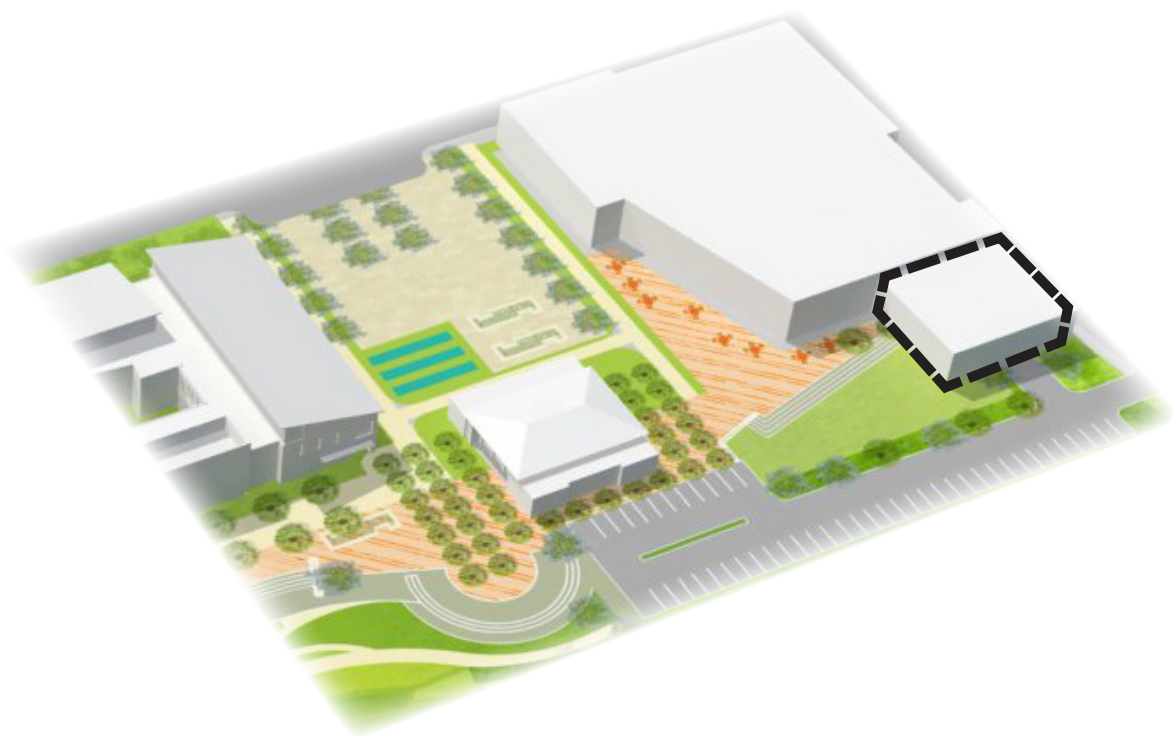

CIVIC LIFE MASTER PLAN

OPEN SPACE- EXPANDED PLAZA



CIVIC LIFE MASTER PLAN

OPEN SPACE- CIVIC GARDEN



July 30, 2014

FEHR + PEERS

WALKER
PARKING CONSULTANTS

PDC Public Dialogue
Consortium

PERKINS
+ WILL

CIVIC LIFE MASTER PLAN

PARKING

UNDERGROUND PARKING BELOW LIBRARY FIELD



ABOVE-GRADE GARAGE

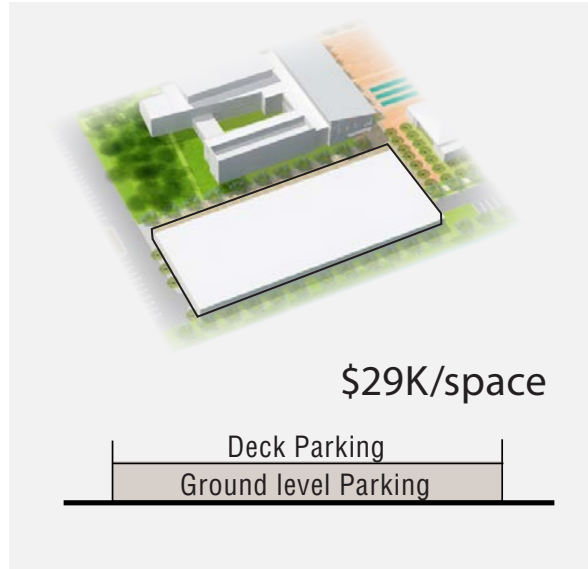

UNDERGROUND PARKING BELOW SURFACE LOT

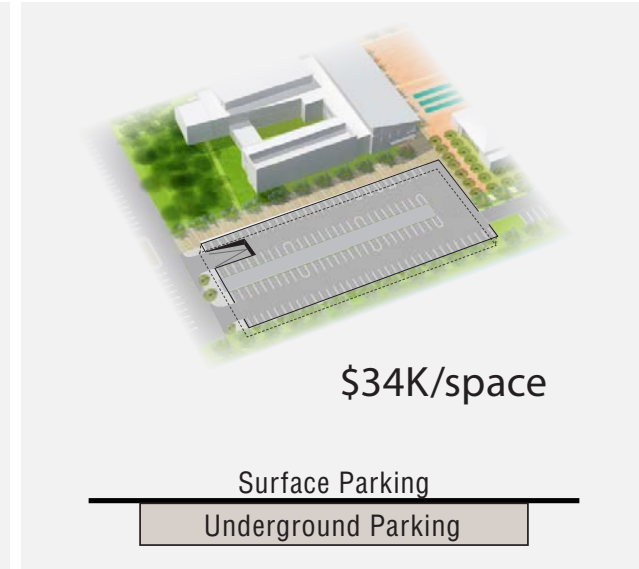

CIVIC LIFE MASTER PLAN

2 ALTERNATIVES

- **OPTION 1: CITY PLAZA**
- **OPTION 2: CIVIC GARDEN**

PLANNED PROGRAM ELEMENTS

NEAR TERM

Library Expansion (Story Room)

2,500 sf extension to existing Library

Teen Center

Proposed 2,000 sf space for Teen uses

Parking Solution

*Current unmet demand + Library expansion
Teen Recreation center*

LONG TERM

Expanded New City Hall

New City Hall + additional community uses

Sheriff's Office (optional)

12,000 sf space with parking need

Parking Solution

*New City Hall + Community uses
Sheriff Office (optional): Additional 80 spaces*

Open Space

Varies in each alternative

CIVIC LIFE MASTER PLAN

OPTION 1: CITY PLAZA

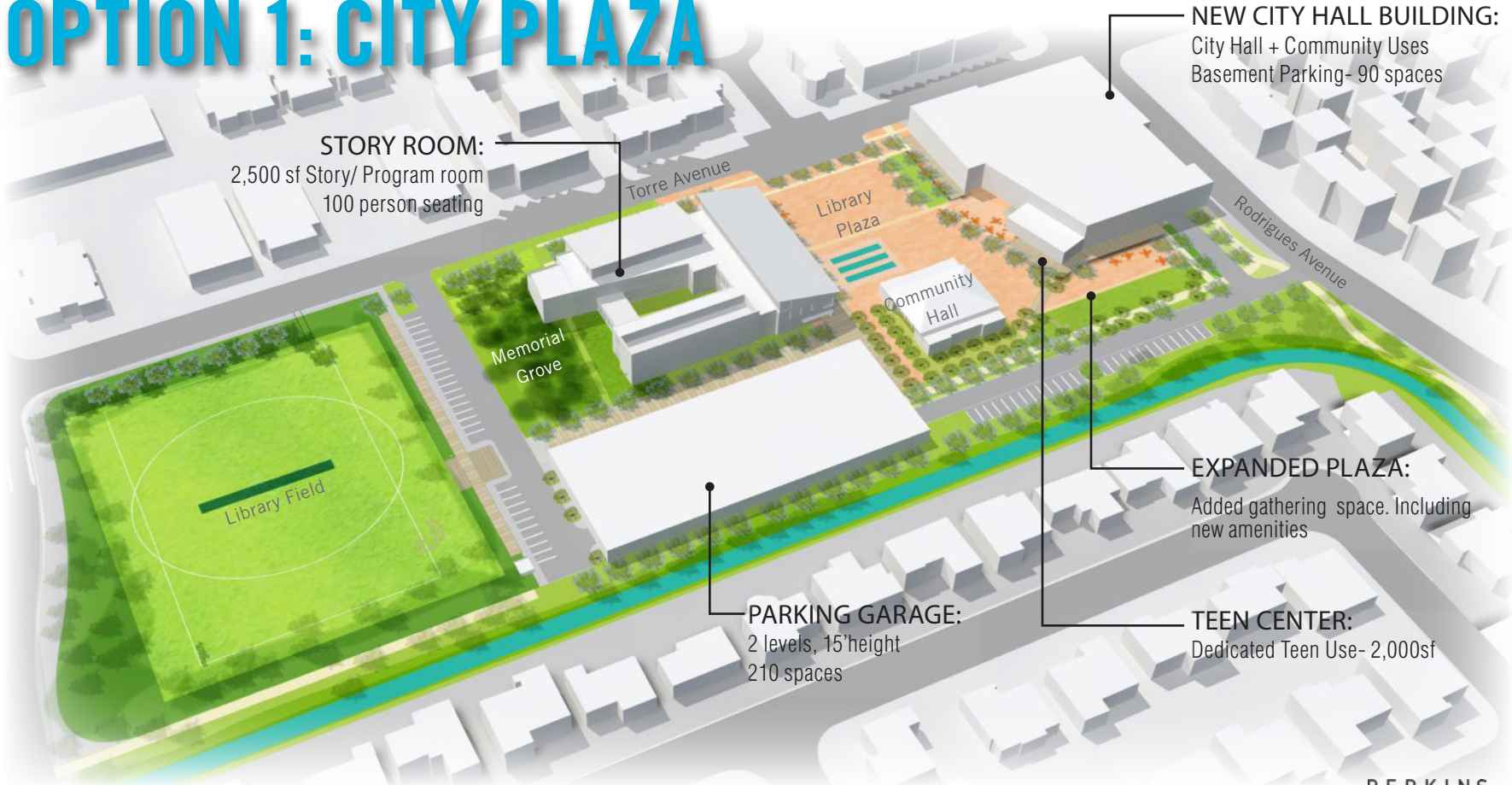

STORY ROOM:
2,500 sf Story/ Program room
100 person seating

NEW CITY HALL BUILDING:
City Hall + Community Uses
Basement Parking- 90 spaces

PARKING GARAGE:
2 levels, 15'height
210 spaces

EXPANDED PLAZA:
Added gathering space. Including
new amenities

TEEN CENTER:
Dedicated Teen Use- 2,000sf

CIVIC LIFE MASTER PLAN

OPTION 2: CIVIC GARDEN

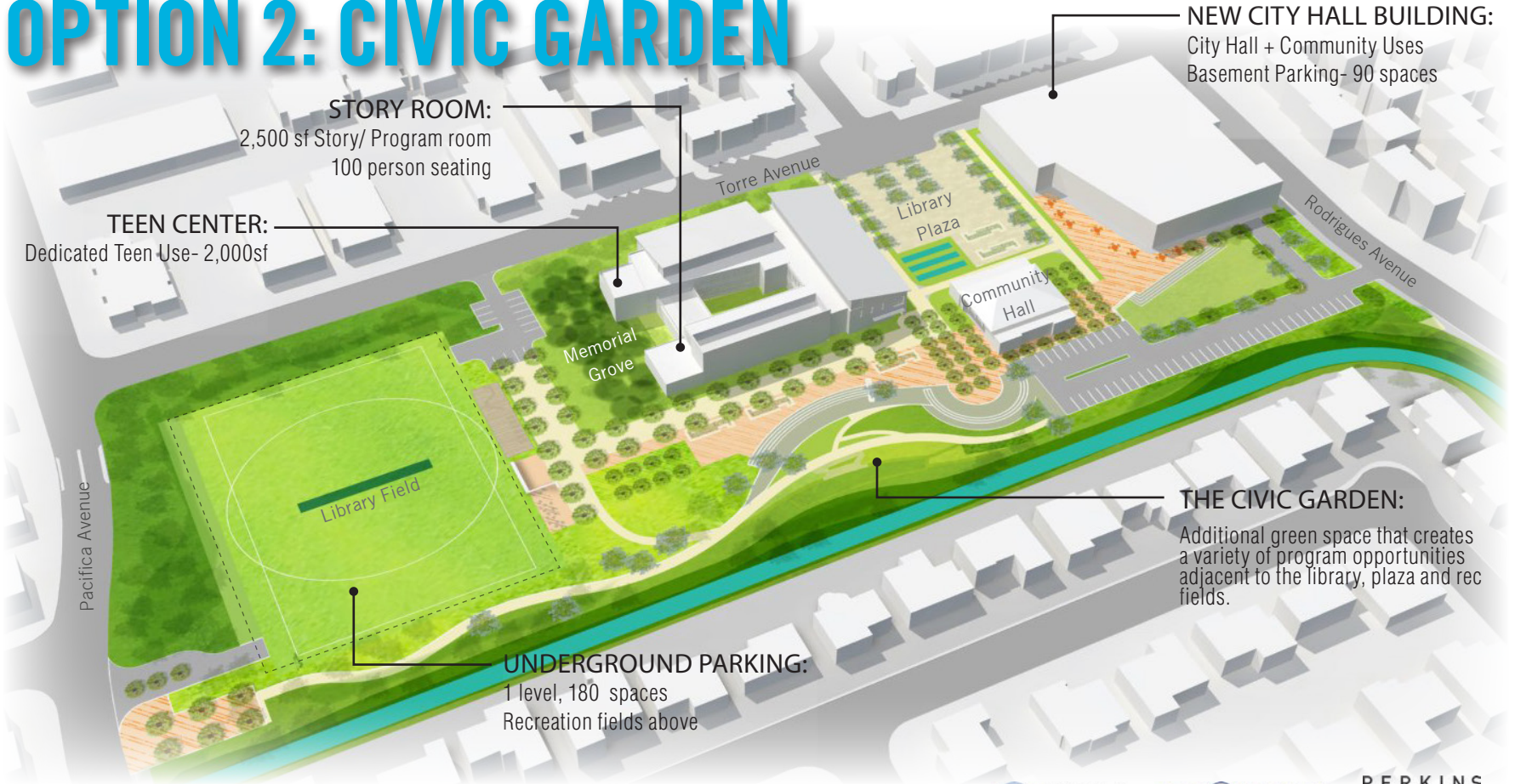

TEEN CENTER:
Dedicated Teen Use- 2,000sf

STORY ROOM:
2,500 sf Story/ Program room
100 person seating

NEW CITY HALL BUILDING:
City Hall + Community Uses
Basement Parking- 90 spaces

Memorial Grove

Library Plaza

Community Hall

Library Field

THE CIVIC GARDEN:
Additional green space that creates a variety of program opportunities adjacent to the library, plaza and rec fields.

UNDERGROUND PARKING:
1 level, 180 spaces
Recreation fields above

CIVIC LIFE MASTER PLAN

QUESTIONS? DISCUSSION

OPTION 1: CITY PLAZA

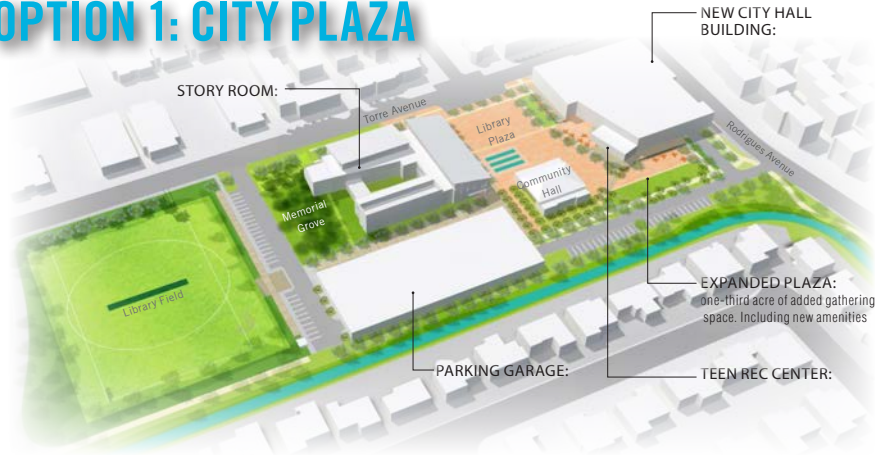

OPTION 2: CIVIC GARDEN

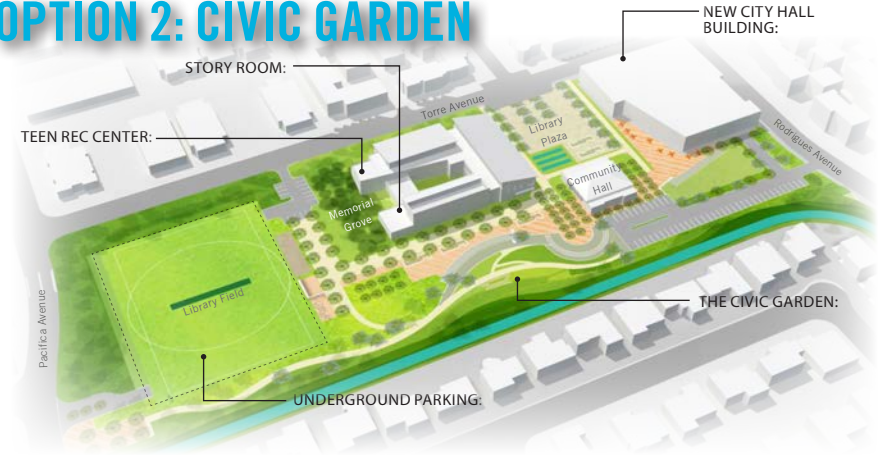

COMMUNITY WORKSHOP
BREAK-OUT GROUPS

CIVIC LIFE MASTER PLAN

HOW IT WORKS

ELEMENTS OF THE PLAN

TEEN CENTER



ACADEMIC FOCUS

- Extension of the library reading room
- Team study rooms
- Lounge area

TECH/MEDIA FOCUS

- Multi-media studio
- Recording studio
- Art studio
- Internet cafe
- Gaming lounge

RECREATION FOCUS

- "Tinkering garage": Think it make it!
- Large multi-purpose room: Bowling, gym, dance hall etc.
- Indoor game area - pool table, ping-pong table, board games etc.
- Link to outdoor recreation courts
- Experimental kitchen

DISCUSSION:

WOULD YOU LIKE TO SEE A TEEN CENTER AT THE CIVIC CENTER?
WHAT TYPE OF PROGRAM SERVES CUPERTINO TEENS BEST?
WHERE IS AN APPROPRIATE LOCATION FOR THE TEEN CENTER?

NEW CITY HALL WITH SHARED SPACE FOR COMMUNITY PROGRAM



CITY PROGRAM

- City Administrative Uses
- Emergency Operations Center
- Council Chambers
- Training/lecture room shared with the community after regular work hours

COMMUNITY PROGRAM

- Shared Atrium/Lobby space that allows an art gallery and community program space
- Meeting rooms/classrooms
- Small performance theater
- Restaurant + Catering kitchen
- Outdoor rooms for large events

WHAT COMMUNITY USES WOULD YOU WANT TO SEE HERE?
HOW MIGHT A NEW CITY HALL CONTRIBUTE TO CUPERTINO'S CIVIC IDENTITY?

SHERIFF'S OFFICE



PROS

- Additional public service use at the Civic Center
- Shared City/County resource

CONS

- Additional 12,000sqft building area
- Requires 80 parking spaces
- Low contribution to civic life/vitality

IS THE SHERIFF'S OFFICE AN APPROPRIATE USE AT THE CIVIC CENTER?

OPEN SPACE PROGRAM



EXPANDED 'CITY PLAZA'

NEW 'CIVIC GARDEN'

PROS

- Indoor/Outdoor community gathering & event spaces for parties, weddings, concert, festival celebrations
- Enhanced landscape
- Seating & shade
- Added lighting and amenities

PROS

- Flexible lawn space
- Picnic areas & resting space
- Stormwater management improvements
- Amphitheater/ outdoor movies
- Extension of plaza
- Spill-out program spaces

WHAT TYPE OF OPEN SPACE ELEMENTS DO YOU WANT AT THE CIVIC CENTER?

PARKING ALTERNATIVES



UNDERGROUND PARKING BELOW LIBRARY FIELD

ABOVE-GRADE GARAGE

UNDERGROUND PARKING BELOW SURFACE LOT

PROS

- Expansive outdoor open space
- Flexibility to expand the built program over time
- Least disruptive
- No visual obstruction

CONS

- Located at the southern end
- Higher construction cost

PROS

- Convenient/centrally-located
- Lower construction cost

CONS

- Prevents later date building program expansion
- Disrupts library field during construction
- Visually obtrusive

PROS

- Convenient/centrally-located
- No visual obstruction

CONS

- Later date building program expansion challenging
- Disrupts library field during construction
- Results in a parking expense with no trees or planting

WHICH PARKING ALTERNATIVE WOULD YOU PREFER? & WHY?
ARE THERE ANY OTHER OPTIONS TO MANAGE THE PARKING DEMAND?

SHAPING THE PLAN

WHICH OF THE OPTIONS IS CLOSER TO YOUR VISION AS DISCUSSED SO FAR?

OPTION 1 - "CITY PLAZA"



OPEN SPACE



PARKING



OPTION 2 - "CIVIC GARDEN"



OPEN SPACE



PARKING



CIVIC LIFE MASTER PLAN

HOW IT WORKS- EXAMPLE

ELEMENTS OF THE PLAN

TEEN CENTER



ACADEMIC FOCUS

- Extension of the library - reading room
- Team study rooms
- Lounge area

TECH/MEDIA FOCUS

- Multi-media studio
- Recording studio
- Art studio
- Internet cafe
- Gaming lounge

RECREATION FOCUS

- "Tinkering garage" : Think it make it!
- Large multi-purpose room : Boxing gym, dance hall etc.
- Indoor game area - pool table, ping-pong table, board games etc.
- Link to outdoor recreation courts
- Experimental kitchen

DISCUSSION:

WOULD YOU LIKE TO SEE A TEEN CENTER AT THE CIVIC CENTER?
 WHAT TYPE OF PROGRAM SERVES CUPERTINO TEENS BEST?
 WHERE IS AN APPROPRIATE LOCATION FOR THE TEEN CENTER?

PARKING ALTERNATIVES



\$53K/space

Library Field
 Underground Parking

UNDERGROUND PARKING BELOW LIBRARY FIELD

PROS

- Expansive outdoor open space
- Flexibility to expand the built program over time
- Least disruptive
- No visual obstruction

CONS

- Located at the southern end
- Higher construction cost



\$29K/space

Deck Parking
 Ground level Parking

ABOVE-GRADE GARAGE

PROS

- Convenient/centrally-located
- Lower construction cost

CONS

- Prevents later date building program expansion
- Disrupts library field during construction
- Visually obtrusive



\$34K/space

Surface Parking
 Underground Parking

UNDERGROUND PARKING BELOW SURFACE LOT

PROS

- Convenient/centrally-located
- No visual obstruction

CONS

- Later date building program expansion challenging
- Disrupts library field during construction
- Results in a parking expanse with no trees or planting

WHICH PARKING ALTERNATIVE WOULD YOU PREFER? & WHY?
 ARE THERE ANY OTHER OPTIONS TO MANAGE THE PARKING DEMAND?

WHAT ARE YOUR ASPIRATIONS FOR THE CIVIC CENTER?



This page intentionally left blank.

APPENDIX A - 04

MindMixer Update with Comments (PDC, Aug 18, 2014)

Cupertino Civic Center Master Plan

MindMixer Update

As of August 18th, 2014 –
 102 active participants
 813 unique visitors
 3808 page views

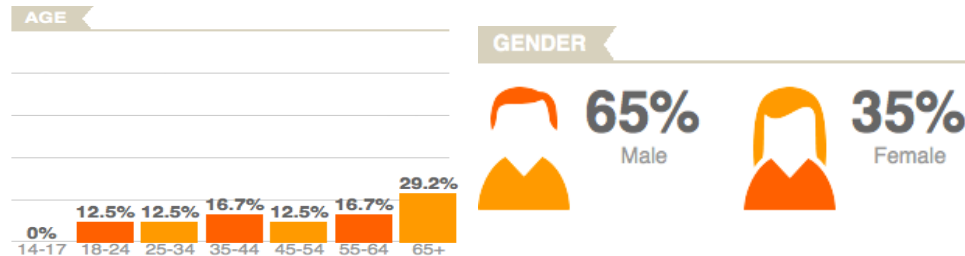

Preferred Design for Cupertino Civic Center

What design of Cupertino Civic Center do you prefer? (Choose one option)

21 votes: Civic Garden Option
 6 votes: City Plaza Option

Comment 1: I would like to keep the area a civic center - no teen center, no restaurants, etc. The Sheriff's office on DeAnza/Saratoga-Sunnyvale Road is close enough. Why should we duplicate that.

Comment 2: Also, I'd welcome the Sheriff's office to Cupertino.

Comment 3: Why do we need another teen center? We already have one...

Comment 4: Neither plan has enough additional parking. Agree with Joseph above that underground parking needs to be expanded. The garden area looks the best but should not be done at the expense of functionality/practicality. Example: the very small lot added by the Memorial Grove - who would use that? It's a small dead-end space. If you are increasing the area's usage (story room with seating for 100) you must provide the parking to go with it. 210 spaces just isn't enough. I still don't think that a Teen Center is a good use of space, but if you insist on it - there are even more parking needs. Don't feel like I can vote for either design as provided.

Comment 5: If the underground parking area is expanded to include under where the civic garden would be, then we'd have ample parking and a beautiful outdoor area for our civic center! Also, the teen center being near the library is more accessible than near the city hall because many teens hang out near the library already (not as much near the city hall).

Comment 6: This is a design that should not only last for the next 30 years, but also represent Cupertino. I envision a show piece that will reflect the city's high tech community. The library already shows a progressive design, and the new civic center should not only match that but possibly eclipse it. Two-story underground parking, integration of a police station (occupied in the near future by the sheriff, possibly by our own police force sometime down the road. The

July 24, 2014

Perkins+Will Consultant Team

overall design should not be short-sighted to accommodate just current needs or alleviate immediate concerns, but project into the future. Yes, short-term needs must be addressed, but don't lose sight of a grander vision.

Comment 7: Yes, good job. Please add a transportation hub to project. Community bus stop, bike, pedestrian and jogger rest area; pushing options to the automobile. A place to fill water bottle, eat a power bar--- you get the idea.

Comment 8: I do not like either option. Why should we add 3500 square feet of room to City Hall when we already have the Quinlan Community Center and the Cupertino Community Center? Is the assumption that bigger is better even if it is a waste of money? Why should the civic center be a park for the surrounding apartment complexes. | By Carolyn H

Comment 9: Please consider continue promoting a green environment for Cupertino. Make it more bike friendly by providing more bike parking spaces and encourage walking to the Civic Center instead of driving. | By Stanley W

Comment 10: The future Civic Center will continue to be our crown jewel; make us proud by hiding the parking and going with a "Garden" like design. Anything less will devalue our brand, we are "Cupertino" after all. | By Gary J

Aspirations for Cupertino Civic Center –Parking

What is the best parking solution for Cupertino Civic Center? (Choose one option)

23 votes: Below ground parking structure under new city hall

20 votes: Below ground parking structure under library field

12 votes: Below ground parking structure at current lot between the creek and the library

4 votes: Above ground parking structure at current lot between the creek and the library

2 votes: None of the above - surface lot expansion

1 vote: Above ground parking structure behind current city hall

6 votes (see comments): Other - please make comments and suggestions

Comment 1: This gets to me because the need for more parking was dismissed by the city when the library was rebuilt. Of course we need more parking - the situation is bad and now it will be even more expensive than ever. There should be no further additions or uses considered to this area without a parking solution. I feel this means a large amount of underground parking. Encouraging bike riding/walking is fine but the vast majority of people visiting city hall/library and whatever else you put in there will be driving.

Comment 2: While it would be more convenient to have more parking at the Civic Center during busy hours, I do not think that it is worth spending millions of dollars to do so.

Comment 3: Subsidize shuttles for students and seniors from Steven creek Blvd. to City Hall, DeAnza college, Cupertino Library, post office and Senior center so, we can stop pollute our air and eliminate heavy traffic in Cupertino especially on Steven Creek Blvd.

Comment 4: As long as parking is below ground, I support where it fits best in the overall plan. I am against a multilevel parking structure above ground; however, a couple of levels below ground would be good.

July 24, 2014

Perkins+Will Consultant Team

Comment 5: This survey is not user friendly or flexible for citizen suggested proposals. Soo..No teen center, no library extension, no sheriff substation, no new city hall until staff can give viable justification and go with the least expensive parking solution which is one level above ground parking structure approx. 15 feet tall. Parking is the immediate problem so lets solve that first and not add to the parking problem with more structures and uses.... | By R M

Comment 6: I also believe that it would be useful to have below ground parking under both the current lot AND some of the library field, because I do not believe that doubling the parking is sufficient and would meet the parking needs of 10-30 years from now. The city hall AND the library patrons both need more parking. This would help. | By Joseph M

Comment 7: Put in more spaces than proposed. The current option only seem to provide for today's need and not the future. Plan for 10 to 20 years out. Past planning is why we have the current problem. | By Gary J

Aspirations for Cupertino Civic Center - Teen Recreation Center

Is a Teen Recreation Center a good addition to the Civic Center? If so, where should it be located? (Choose one option)

26 votes: No Teen Recreation Center at Cupertino Civic Center

18 votes: Teen Recreation Center as part of the library expansion

6 votes: Teen Recreation Center stand alone located behind the library along Torre Ave

6 votes: Teen Recreation Center stand alone located on the Civic Center Plaza

3 votes: Teen Recreation Center as part of a new and expanded City Hall

3 votes: Other - Please add your comments and suggestions

Comment 1: I thought there was already a teen center at the sports center. It could also be at the Quinlan Center. I would not put additional funds into building another space for a teen center. How much is it currently used? I would imagine that most teens wouldn't be caught dead there. Just my opinion based on my kids' opinions.

Comment 2: Teen Recreation Center may be located inside the community hall or inside the city hall, or stand alone at Cupertino Civic Center. I suppose may depend of the services of teenagers to serve the City (CARES, CERT or Park and Rec) or serve the community (clubs, schools, churches....)

Comment 3: We can have a teen center inside Cupertino Library and it will work if the City Hall decides to have free or subsidized Half Price shuttles ride a long Steven Creek Blvd to the Cupertino library. So, the parents and teens do not have to drive while the City Hall does not have to add additional Parking spots and spending extra money that we all should save for the future year.

Comment 4: Originally I thought that a teen center at Civic Center made sense; however, I have changed my vote after learning that such a teen gathering place already exists at Quinlan. No need to duplicate since they are so close in proximity.

Aspirations for Cupertino Civic Center - City Hall

What programs would you like to see included in the new City Hall? (Choose all that apply)

49 votes: Addition of an underground parking structure

30 votes: Addition of performing arts and cultural programming space

26 votes: Addition of a cafe with quality food

24 votes: Addition of meeting rooms and classrooms

18 votes: Addition of a Teen Recreation Center

16 votes: Addition of an art gallery

Other programming or building ideas - Please add your comments and suggestions:

Comment 1: I don't understand why the City wants to spend millions on a better City Hall when there are plenty of infrastructures that need improving around the city. Reduced traffic congestion, safer and extended biking, hiking and walking trails and routes, safer cross walks and sidewalks, better routes to school, better public transportation and so much more are needed far more than a nicer City Hall. I use City Hall only a couple of times a year at most but walk, bike, hike, and shop in and around our city daily. Let us put the millions on making our city better for everyone to live and recreate including visitors. I constantly hear that the city does not have enough funds for such infrastructure so how can they have funds for a new City Hall? I asked for bike lanes to be painted neon green and the Bike and Pedestrian Commission said it will be done over a number of years due to the lack of funds. So what are we doing building a new multi-million dollar City Hall? Doesn't safety come ahead of luxury? | By Frank G

Comment 2: I appreciate all the hard work that has gone into this project and sorry I am late to the party. Adding to my comment below; a comfort zone for bike/ped/joggers/etc people should include shade, a suitable water fountain to refill water bottles, a picnic type table to eat our snacks and have conversation with like minded people, a bike rack that actually makes sense, etc. A specific zone like this would be a positive statement from the City that they support and encourage getting out of cars, vans and trucks. The Zone should be located where eventually community buses would service the Center. Once the Zone was completed and the bike/ped corridor from foothill blvd down McClellan to the Center is added a second corridor from the Center to the Main Street Project might make sense. Adding arteries as funding becomes available. This would connect many to the schools and library as well. Feedback please IMHO | By Gary J

Comment 3: These questions make me wonder what's happening to the Quinlan Center? Don't we have art galleries, classrooms etc... there? One of the mistakes made when the library was rebuilt (besides lack of parking) was sticking the coffee house in a far corner away from everything with no access from the library itself. It is so poorly situated and seems like an afterthought. The tables blocking the walkway are not inviting at all. It's a wonder they are still in business. They should be along the inner courtyard with access from inside the main hall of the library - or some place where it feels like a part of the scene and that encourages people to hang out and use it. Obviously, there needs to be a way to keep food and drink from mixing with the books, but other libraries have done this successfully and it makes things much more inviting. Right now the library courtyard is just under utilized space, in my opinion. | By Tina V

Comment 4: Many great ideas and community input. Thank you for asking. I would like to see the Civic Center also become the hub for human mobility as an alternative to getting in our automobiles. Maybe a comfort zone for pedestrians, bikers, walkers, runners, and eventually a community bus center. This 'comfort zone' would be a vital step to implementing the Bike/Ped Plan already approved. A significant gesture to many in our community that the City plans to support environmentally friendly alternatives to cars, trucks and vans. The Council could then approve, in the mid-year budget review that part of "the Plan" for a mobility corridor from Foothill Blvd Down McClellan to the Civic Center and back. This would allow many a safer route to and from the Center. | By Gary J

Comment 5: Would Love to see a small free bus from Steven Creek Blvd. to the City Hall and Library so we can eliminate the traffic in Cupertino. My take and opinion. | By Thorisa Y

Comment 6: Excellent idea. | By Robert M

Aspirations for Cupertino Civic Center - Recreation & Open Space **What recreation improvements would you like to see for the Civic Center Plaza & Library Field? (Choose all that apply)**

33 votes: Creekside trail improvements

32 votes: Addition of picnic tables, trees for shade, and family gathering areas

22 votes: Maintain library field & program

22 votes: Addition of bike paths and/or bike parking

16 votes: Addition of a play structure, playground in library field

15 votes: Addition of a jogging track around library field

13 votes: Addition of an outdoor amphitheater

9 votes: Addition of an all ages Recreation Center in library field

7 votes: Addition of outdoor movie screening area

3 votes: Purpose library field for other programs. Please add your comments and suggestions.

Comment 1: Campbell has a summer music program that takes place in their Civic Center Area on Thursdays evenings -- it is usually a packed house. I think that type of recreation /entertainment would be a great addition to the Civic Center. An amphitheater would be perfect for that but it would have to have other uses. A covered stage would and a large grassy area for blankets and lawn chairs would be adequate. | By Doug F

Comment 2: The field is a dead space and its future use needs to be carefully considered. Being that it's in the back of the other buildings without easy overall access to all makes it a poor choice for a play area. If you are stuck on moving the Sheriff's office to this area maybe that's where you should put it.. providing that plenty of additional parking is provided. Creekside trail improvements are always good. More connecting bike/walking trails would be great. | By Tina V

Aspirations for Cupertino Civic Center - Sheriff's Office **Should the Sheriff's Office be relocated to the Civic Center? (Choose one option)**

30 votes: No, it is not a good addition to the civic center

16 votes: Yes, a 12,000 square foot building with appropriate parking should be added

4 votes: Other comments and suggestions

Comment 1: I don't think we have enough information to judge this, really. Is that the ideal spot for the Sheriff and whatever business/people they will bring in? I don't know. I would think that it would bring a lot more noise and traffic/parking concerns. | By Tina V

Comment 2: It may be more convenient to allocate emergency service or have sheriff patrol the area in time of need, but the question is what are the additional costs, where is located right now. Do we need the new addition? | By Judy W

Comment 3: Why would we use valuable City real estate for a County function also serving other nearby cities? Give up parking spaces; no way! | By Gary J

Comment 4: At the most recent public workshop it was presented that the SCCSO required 80+ parking spaces which made the majority of attendees upset. I have reason to believe that this number is incorrect..I would also like to know why only one option was presented rather than the alternatives that included a single standing building with enclosed parking.

Being that the SCCSO has provided exemplary service to Cupertino since 1955 it only makes sense they are part of our local government and should be located within our city , currently we have send Cupertino residents to San Jose for any business or clerical issues that they may require. It is extremely important that the facts are presented when asking members of the community to be part of a decision making process of this magnitude. | By Robert M

This page intentionally left blank.

APPENDIX A - 05

Community Feedback Summary Presentation (Aug 18, 2014)

This page intentionally left blank.

CIVIC CENTER MASTER PLAN

CIVIC LIFE

COMMUNITY FEEDBACK SUMMARY



CITY OF CUPERTINO
AUG. 14, 2014

FEHR & PEERS



PERKINS
+ WILL

CIVIC LIFE MASTER PLAN

COMMUNITY ENGAGEMENT PURPOSE



COMMUNITY ENGAGEMENT PROCESS

EARTH DAY EVENT



summary

- *Volunteer based interviews*
- *Guided by Questionnaire*
- *Focusing on “What should this place be?”*

140 on-site
interviews

COMMUNITY ENGAGEMENT PROCESS

STAKEHOLDER MEETING



summary

- Idea generating presentation
- Planning game break out groups
- 3 concept options presented
- Feedback to City Council for review

12 attendees

8 groups represented

CIVIC LIFE MASTER PLAN COMMUNITY ENGAGEMENT PROCESS ONLINE FEEDBACK

The screenshot shows a web browser window with the URL www.imaginecupertinociviccenter.org. The navigation menu includes Home, Topics, Activity, and About. A search bar and a 'Sign Up' button are also visible. The main content area features a large image of a building with a fountain in the foreground. Below the image is a welcome message: "Welcome to Imagine Cupertino Civic Center. Welcome! We are engaging our community to gather input and feedback from a broad range of Cupertino residents regarding our civic center infrastructure and design. Tell us your ideas. Your input is valuable and will guide future planning." Below the message are two buttons: "Connect with Facebook" and "Sign Up with Email". Below the main content is a "Topics" section with the text "Join the discussion and add to current topics. View All Topics". A specific topic is highlighted: "Aspirations for Cupertino Civic Center - City Hall", posted on Jun 3 with 7 interactions and 33 days remaining.

summary

- *Continual survey to reach the most people*
- *Survey questions by Program element*
- *2 preferred concepts for public comment*

89 active participants

779 unique visitors

3610 page views

** updated 8/11/2014*

CIVIC LIFE MASTER PLAN

COMMUNITY ENGAGEMENT PROCESS

PUBLIC WORKSHOP- JULY 30



summary

- Presentation and eight break-out groups
- 2 concept options presented and discussed
- Selected program elements considered

56 attendees

ITEMS OF GENERAL CONSENSUS

Open Space

A strong desire for additional open space: trees, shaded places, family-oriented areas and community gathering areas

Parking

Underground parking was highly desired

Sheriff's Substation

No benefit seen to locating substation at Civic Center

WHAT WE HEARD: OPEN SPACE

PUBLIC WORKSHOP DISCUSSION:

WHAT TYPE OF OPEN SPACE ELEMENTS DO YOU WANT AT THE CIVIC CENTER?



EXPANDED 'CITY PLAZA'



NEW 'CIVIC GARDEN'

SUMMARY OF FINDINGS:

- A strong desire for additional open space: trees, shaded places, family-oriented areas and community gathering areas
- More **unstructured open space**. One that offers more natural features, sustainable site strategies and more flexible uses
- A strong desire to maintain and build upon the **existing plaza**
- Improved **mobility options** through the open spaces (bike access, bike parking, trails, shuttles, etc) were recommended

CIVIC LIFE MASTER PLAN

WHAT WE HEARD: PARKING

PUBLIC WORKSHOP DISCUSSION:

WHICH PARKING ALTERNATIVE WOULD YOU PREFER? & WHY?
ARE THERE ANY OTHER OPTIONS TO MANAGE THE PARKING DEMAND?



\$53K/space

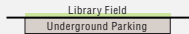

**UNDERGROUND
PARKING
BELOW LIBRARY FIELD**

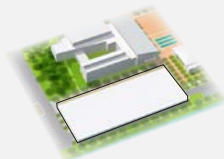

\$29K/space

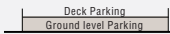

ABOVE-GRADE GARAGE

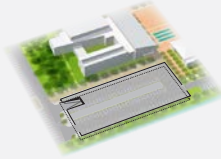

\$34K/space



**UNDERGROUND
PARKING
BELOW SURFACE LOT**

SUMMARY OF FINDINGS:

- **Underground parking was highly desired**
- 70% of online participants prefer **underground** parking
- 7 of 8 workshop groups prefer **underground** parking
- Majority of online and workshop participants prefer **underground parking below library field**
- Majority supported underground parking **below a new City Hall building**

WHAT WE HEARD: SHERIFF SUBSTATION

PUBLIC WORKSHOP DISCUSSION:

IS THE SHERIFF'S SUBSTATION AN APPROPRIATE USE AT THE CIVIC CENTER?



SUMMARY OF FINDINGS:

- **No benefit seen to locating substation at Civic Center**
- 24hr activity of a sheriff station **perceived disruptive** to neighbors
- 80 spaces of sheriff parking perceived as **burden**
- Desire to **hear from sheriff** as to why they want to be part of Civic Center?

ITEMS OF MIXED REACTIONS

Teen Center

Majority of people questioned the need for a dedicated teen center. There was a common request for more information and input from teens.

Expanded New City Hall

While some questioned the need for a new building, many were excited about the opportunities a new City Hall presented in the future. Civic focused building with 'limited' shared uses was recommended.

WHAT WE HEARD: TEEN CENTER

PUBLIC WORKSHOP DISCUSSION:

WOULD YOU LIKE TO SEE A TEEN CENTER AT THE CIVIC CENTER?
WHAT TYPE OF PROGRAM SERVES CUPERTINO TEENS BEST?
WHERE IS AN APPROPRIATE LOCATION FOR THE TEEN CENTER?



ACADEMIC FOCUS



TECH/MEDIA FOCUS



RECREATION FOCUS

SUMMARY OF FINDINGS:

- Majority of people questioned the need for a dedicated teen center.
- There was a common **request for more information** and **input from the teens**
- Teen center was desired to be a **flexible space**, available for **all age groups**.
- **Tech/ media** focus use was considered valuable

WHAT WE HEARD: NEW CITY HALL

PUBLIC WORKSHOP DISCUSSION:

WHAT COMMUNITY USES WOULD WANT TO SEE HERE?
HOW MIGHT A NEW CITY HALL CONTRIBUTE TO CUPERTINO'S CIVIC IDENTITY?



SUMMARY OF FINDINGS:

- While some questioned the need for a new building, many were excited about the opportunities a new City Hall presented in the future.
- **Civic focused** building with 'limited' shared community uses was recommended
- Majority recommend **parking below** City Hall (if a new City Hall is built)
- Support for community **uses varied**: meeting rooms, class rooms, food/restaurants, and gallery spaces
- Majority **questioned the need for a theater**

CIVIC LIFE MASTER PLAN

OPTION 1: CITY PLAZA

2 of 8 groups prefer this option

Modifications

Underground parking below library field was suggested

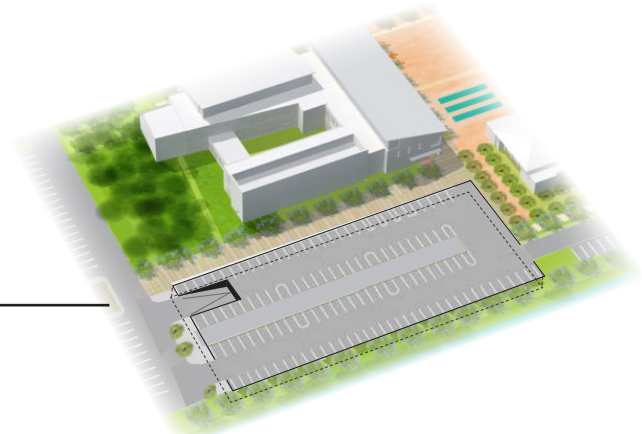

Modifications

Above grade garage was replaced with a hybrid of below ground and ground level parking

WHICH OF THE OPTIONS IS CLOSER TO YOUR VISION AS DISCUSSED SO FAR?

OPTION 1 - "CITY PLAZA"

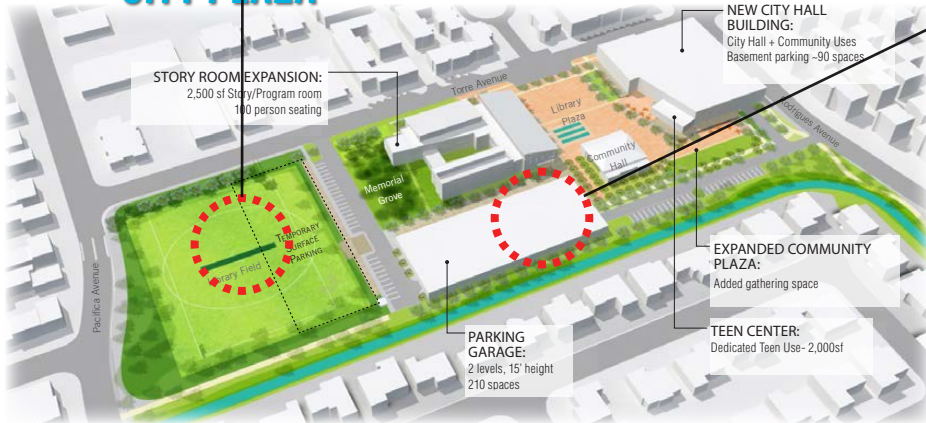

CIVIC LIFE MASTER PLAN

OPTION 2: CIVIC GARDEN

6 of 8 groups preferred this option

Modifications

More parking below ground and on the surface.

Modifications

Underground parking below the surface lot connected to the basement parking below a new City Hall.

OPTION 2 - "CIVIC GARDEN"

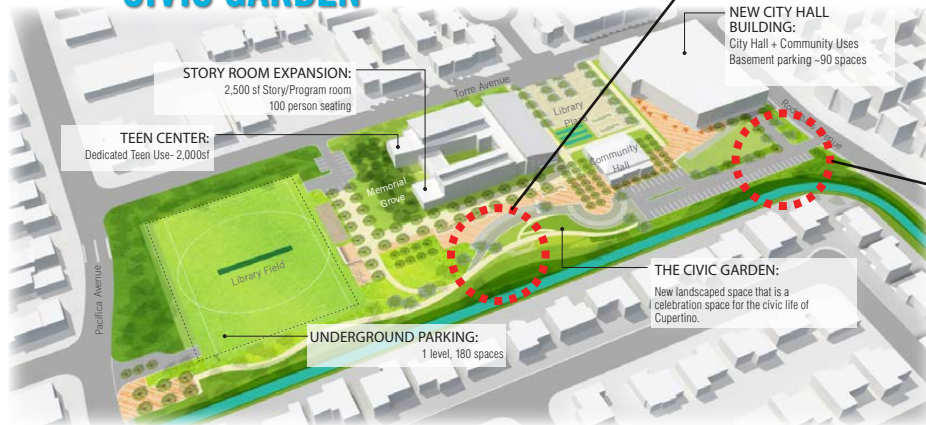

This page intentionally left blank.

APPENDIX A - 06

Existing Transportation Conditions Analysis (F+P, May 29, 2014)

MEMORANDUM

Date: May 29, 2014

To: Karen Alschuler, Perkins + Will
Geeti Silwal, Perkins + Will
Brian Chambers, Perkins + Will

From: Jane Bierstedt, Franziska Church, Lindsey Hilde, Fehr & Peers

Subject: Revised Draft Existing Parking Conditions at the Cupertino Civic Center

SJ14-1500

The Cupertino Civic Center contains City Hall, Community Hall, Cupertino Library, and Library Field. As part of the planning for the Civic Center Master Plan (CCMP) a parking analysis is being conducted to identify the existing parking challenges and provide recommendations for parking improvement solutions. This memorandum documents the existing parking conditions at the site, including existing parking supply and demand. The existing conditions documented in the memorandum occurred before the city made changes related to designating permit parking and the four-hour time limits in the City hall and library parking lots.

PROJECT BACKGROUND

The Cupertino Civic Center is home to the Cupertino City Hall, Community Hall, Cupertino Library, and Library Field, a recreational playing field, as shown on **Figure 1**. The parking lot provides parking for all of the Civic Center's employees and visitors, and some City vehicles.

A total of 92 employees currently work at City Hall. A parking survey of Civic Center employees conducted by the City in March 2014 indicated that 96 percent of City employees drive alone to work. The Community Hall and Library hold daily, weekly, and monthly events and programming. Recent visitor data showed that the library attracts anywhere from 1,600 visitors on a typical Friday to 2,656 visitors on a typical Tuesday. Saturdays are the busiest days at the library, with 3,315 visitors. The Community Hall attracted 16,790 visitors in the 2010-2011 fiscal year, which averages to about 67 visitors per weekday.



Parking demand at the Civic Center exceeds the existing parking lot supply on most weekday afternoons. Many employees and visitors report having to circle the parking lot several times before a parking space becomes available. This can be inefficient for employees and a deterrent to the visitors who rely on the Civic Center's programming and services. Circling or "cruising for parking" causes congestion in the parking lots and can pose safety hazards for motorists and pedestrians. In addition, it is not sustainable, as cruising for parking increases greenhouse gas emissions.¹ The on-street parking spaces that line the perimeter of the Civic Center can help meet the existing demand, but this added supply is still not sufficient to meet the current unmet need.

SITE ACCESS

The following section describes the existing transportation facilities that provide access to the Civic Center. The adjacent roadways are shown in **Figure 1**. Existing transit and bicycle facilities are displayed in **Figure 2**.

Roadways

The following roadways provide direct access to the site: Rodrigues Avenue, Torre Avenue, and Pacifica Drive. Rodrigues Avenue is a two lane, two-way street that borders the Civic Center to the north. Condominiums are located across the street from the Civic Center on Rodrigues Avenue. Torre Avenue is a two lane, two-way street bordering the Civic Center to the west. There is a mix of housing, offices, and a small cafe on Torre Avenue. Pacifica Drive borders the Civic Center to the South along the Library Field. Pacifica Drive is lined with single-family homes.

Transit Service

Three Santa Clara Valley Transportation Authority (VTA) bus routes circulate near the Civic Center. VTA Routes 53 and 55 run along De Anza Boulevard. VTA Route 55 has stops at De Anza Boulevard / Pacifica Drive and De Anza Boulevard / Rodrigues Avenue. VTA Route 23 runs along Stevens Creek Boulevard.

¹ Shoup, Donald. "Cruising for Parking." *Access Magazine*: 2007. Available at: <http://shoup.bol.ucla.edu/CruisingForParkingAccess.pdf>



Path: N:\Projects_SJ14_Projects\SJ14_1500_Cupertino Civic Center Master Plan\Graphics\ADOBE\Fig_1_Project_Site.at



Figure 1
Project Site

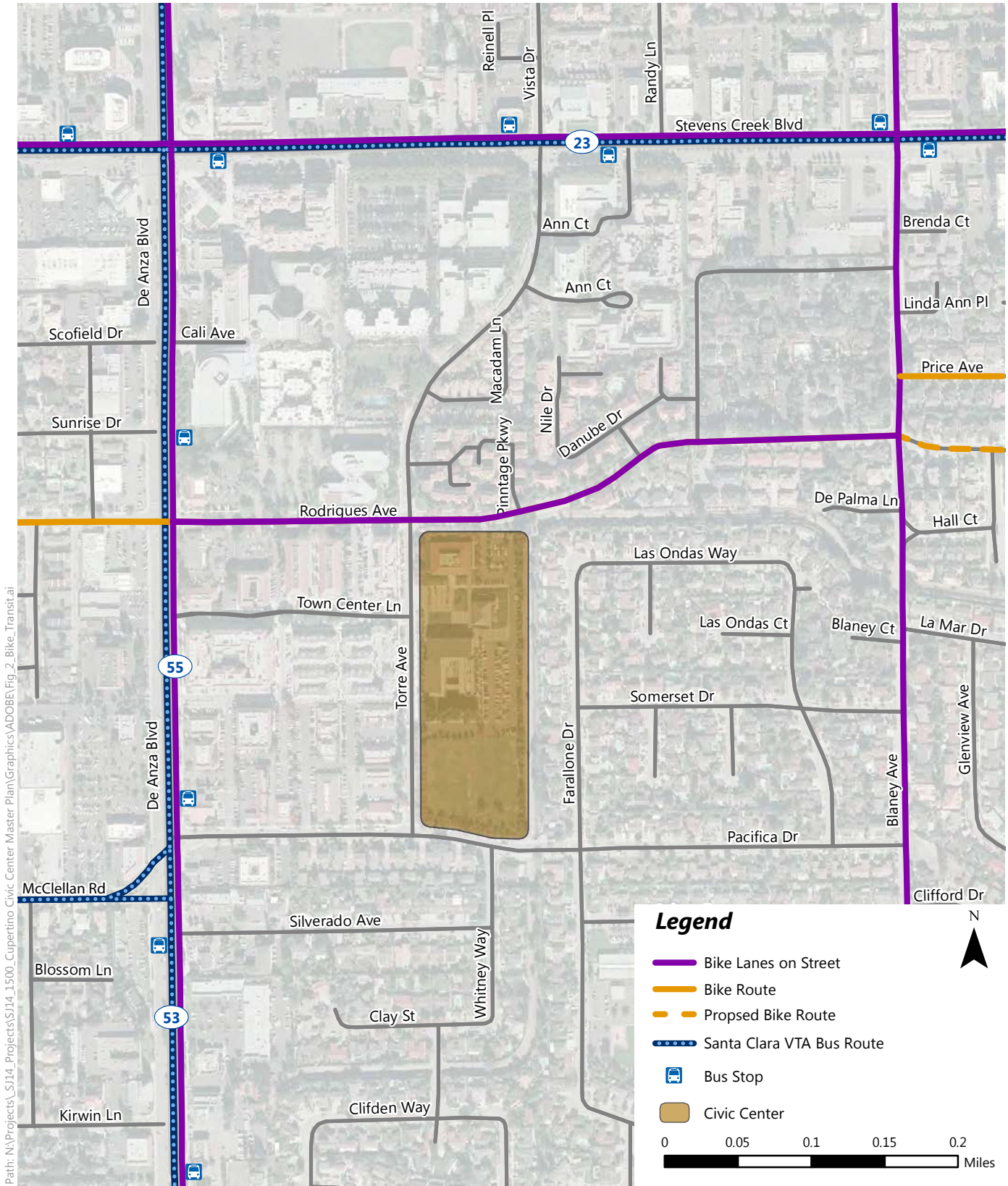

Figure 2
Transit Routes and Bicycle Facilities



Bicycle Facilities

On-street bicycle lanes exist on De Anza Boulevard, Stevens Creek Boulevard, and Blaney Avenue. Rodrigues Avenue is a designated bicycle route.

EXISTING PARKING SUPPLY

Aerial photographs, the Civic Center site plan, and site visits were used to quantify the available parking supply in the on-site lots and in the adjacent on-street spaces. There is no charge for parking on the site or along the side streets surrounding it (Rodrigues Avenue to the north and Torre Avenue to the east). Dates and times of the parking surveys and field work are detailed in the next section.

Vehicle Parking

The existing vehicle parking supply and restrictions or special designations according to use/purpose are presented on **Figure 3**.

The Civic Center currently provides 230 parking spaces in the shared surface parking lot. The parking lot has seven (7) ADA spaces: two (2) next to City Hall and five (5) next to the Library. There are four (4) 4-minute short-term parking spaces next to the library entrance. Two (2) electric-vehicle (EV) parking stations are provided on Rodrigues Avenue, just east of the Civic Center driveway. There is one (1) space designated for the Mail Clerk and one for Maintenance in the City Hall Lot.

A total of 39 on-street parking spaces are provided on select parts of the streets adjacent to the Civic Center and were included in the existing conditions parking supply analysis. There are 15 delineated parking spaces on Rodrigues Avenue and 24 delineated parking spaces on Torre Avenue. Delineated parking spaces are defined by posted parking signs and/or pavement markings. These 39 spaces were included in parking supply calculations due to their close proximity to the Civic Center. However, there are also on-street spaces located further from the Library and City Hall bordering the Library Field along Torre Avenue and on Pacifica Drive (**Figure 3**). There are no posted parking signs or pavement markings on the block of Pacifica Drive adjacent to the Library Field; however parking is allowed on this stretch of road, which has room for approximately 14 parking spaces. The total supply of parking spaces at the Civic Center is the sum of the off-street parking (230) and the on-street parking (39), which is 269 spaces.



Bicycle Parking

The City has five (5) bicycle lockers intended for employee use. However, the bicycle lockers are being used primarily for bicycle storage rather than bicycle parking. There are no bicycle racks next to City Hall or the Community Hall, however Community Hall users can use the racks by the south side of the building. The Library has a total of 37 bicycle parking spaces: 32 spaces on bicycle racks near the book drop-off, and five (5) spaces at a moveable bicycle rack next to Coffee Society.

EXISTING PARKING DEMAND

On-the-ground surveys are commonly used to determine the parking demand for a particular site. The data gathered during such a survey is the preferred method used in determining parking demand; it represents actual observed demand under typical operating conditions. The data presented below was collected by Fehr & Peers on the following days: Thursday, April 3, 2014 between 11:00 AM and 6:00 PM and Saturday, April 12, 2014 from 12:00 PM to 3:00 PM. On Thursday April 3, 2014, the following events took place at the Community Hall: Environmental Review Committee (9:00 AM), Parks and Recreation Commission Meeting (5:00 PM), and C.A.R.E.S. (Cupertino Amateur Radio Emergency Service) Meeting (7:00 PM). On Saturday April 12, 2014, no scheduled community events took place. On Thursday, April 24, 2014, an Administration Hearing Meeting took place at 5:00 PM.²

Additional field observations were conducted on Thursday, April 24 between 9:00 AM and 10:00 AM and 2:30 and 4:30 PM. The morning observations were conducted to count the number of vehicles associated with City Hall in the City Hall portion of the lot (the North Lot), as the majority of employees arrive at work before 8:30 AM (Civic Center Parking Survey, 2014) and the library is not yet open. Observations were conducted between 2:00 and 4:00 PM, when demand in both the North and South Lots peak, to measure the number of vehicles circulating in the lot and people parking off-site and walking.

²City of Cupertino Calendar of Events. Available at: <http://www.cupertino.org/index.aspx?page=18>

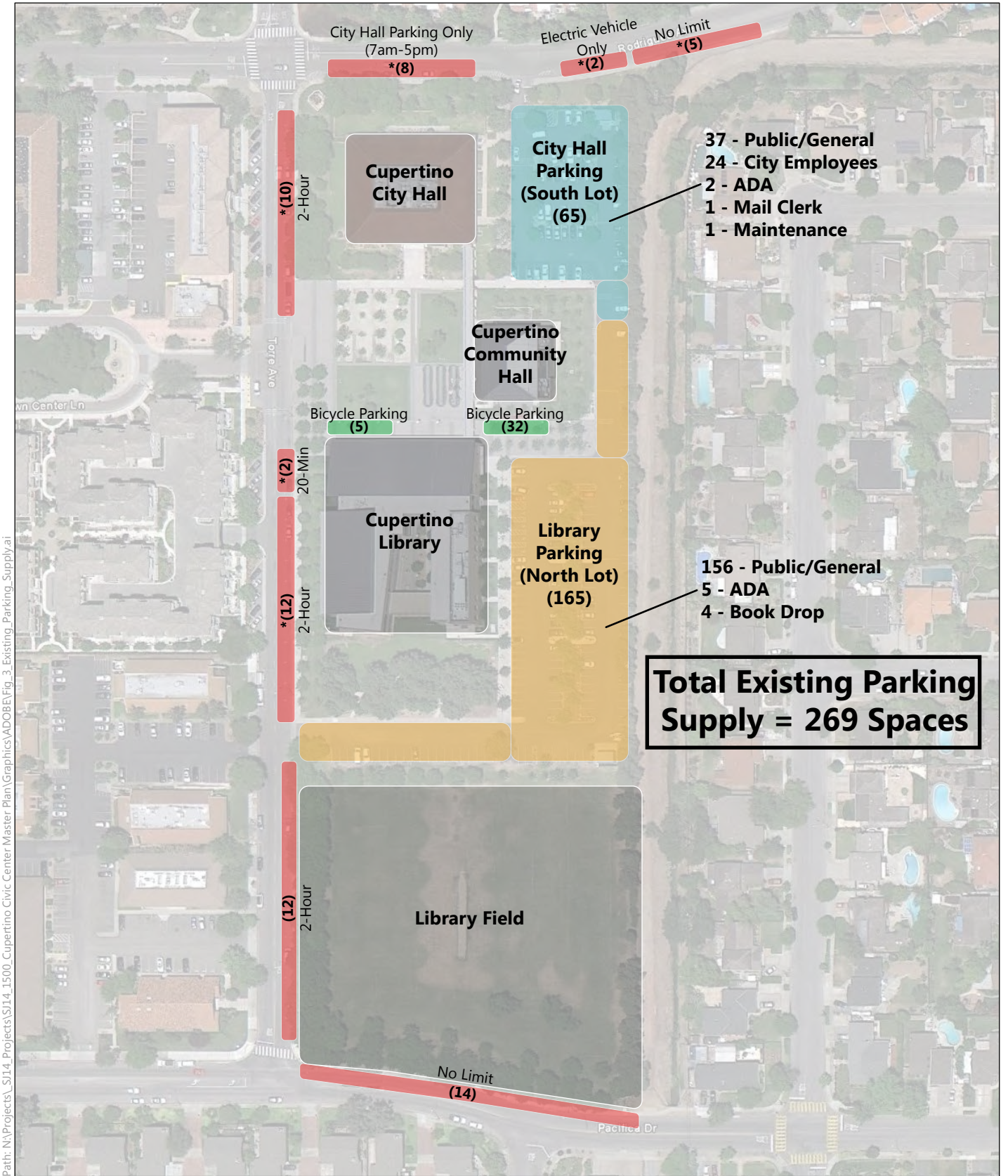

Path: N:\Projects\SJ14_Projects\SJ14_1500_Cupertino Civic Center Master Plan\Graphics\ADOBE\Fig_3_Existing_Parking_Supply.ai

(XX) = Number of parking spaces available
*** = Included in parking supply analysis due to proximity to site**

Note: All two hour on-street parking along Torre Avenue is restricted between 8AM and 5PM on weekdays.



Figure 3
 Existing Parking Supply



Parking occupancy (numbers of spaces occupied with a parked vehicle) was surveyed at the following locations on or bordering the site:

- City Hall Lot/North Lot
- Library Lot/South Lot
- Torre Avenue (western border of site)
- Rodrigues (northern border of site)

Overall Weekday Parking Demand

Figure 4 shows average weekday occupancy rate over the course of the survey period on Thursday, April 3. The average occupancy rate for both on-street and parking lot spaces was 92 percent, with the highest at 97 percent at 4:30 PM. The average occupancy rate for the lot with the highest average occupancy was the South Lot, at 94 percent. Occupancy rates for each count location are as follows:

- North Lot
 - Average occupancy rate was 89%
 - Highest occupancy rate was 97% (11:00 AM and 4:30 PM)
- South Lot
 - Average occupancy rate was 94%
 - Highest occupancy rate was 98% (11:00 AM, 2:30 PM, and 3:30 PM)
- Torre Avenue
 - Average occupancy rate was 83%
 - Highest occupancy rate was 100% at 4:30 PM
- Rodrigues Avenue
 - Average occupancy rate was 97%
 - Highest occupancy rate was 100% (between 11:00 AM – 12:00 PM, 1:30 to 5:30 PM)

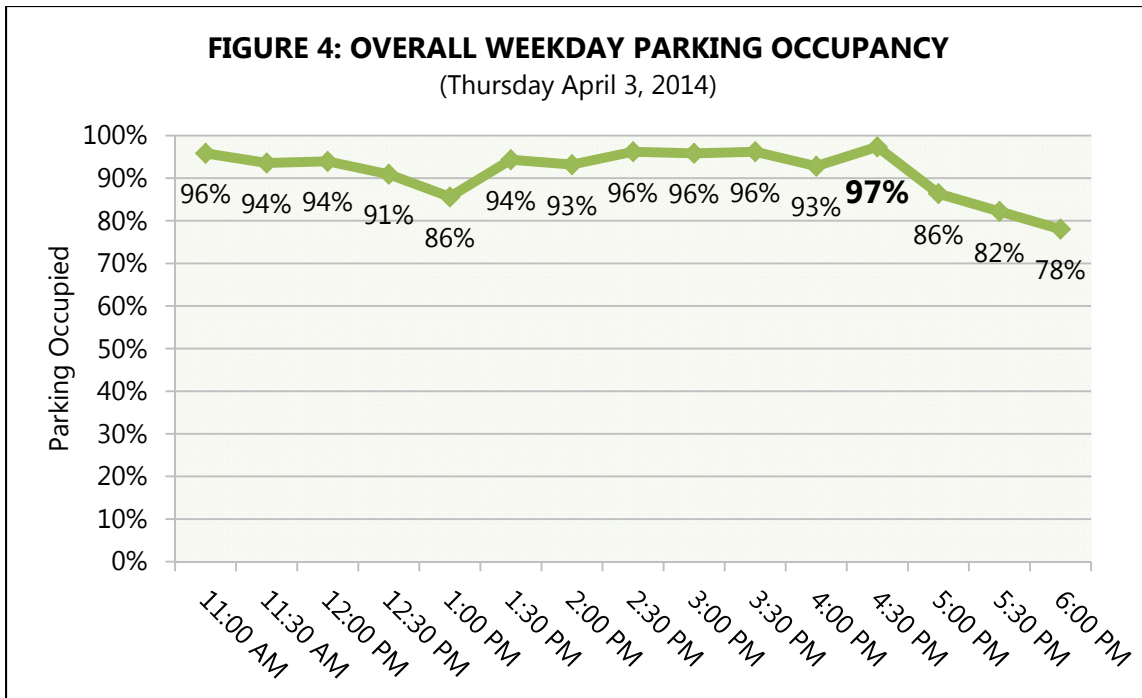

Source: Fehr & Peers, 2014

Overall Weekend Parking Demand

Figure 5 shows average weekend site occupancy rates over the course of the survey period on Saturday, April 12. The overall average site occupancy was 80 percent, slightly lower than the weekday sample. The highest average occupancy rate of all count locations was 89 percent at 3:00 PM. Torre Avenue and the South Lot had the highest average occupancy rate, both at 97 percent. Occupancy rates for each count location are as follows:

- North Lot
 - Average occupancy rate was 65%
 - Highest occupancy rate was 82% at 3:00 PM
- South Lot
 - Average occupancy rate was 87%
 - Highest occupancy rate was 96% (2:30 PM to 3:00 PM)
- Torre Avenue



- Average occupancy rate was 87%
- Highest occupancy rate was 96% (12:30 to 1:00 PM)
- Rodrigues Avenue
 - Average occupancy rate was 43%
 - Highest occupancy rate was 70% (1:00 to 1:30PM)

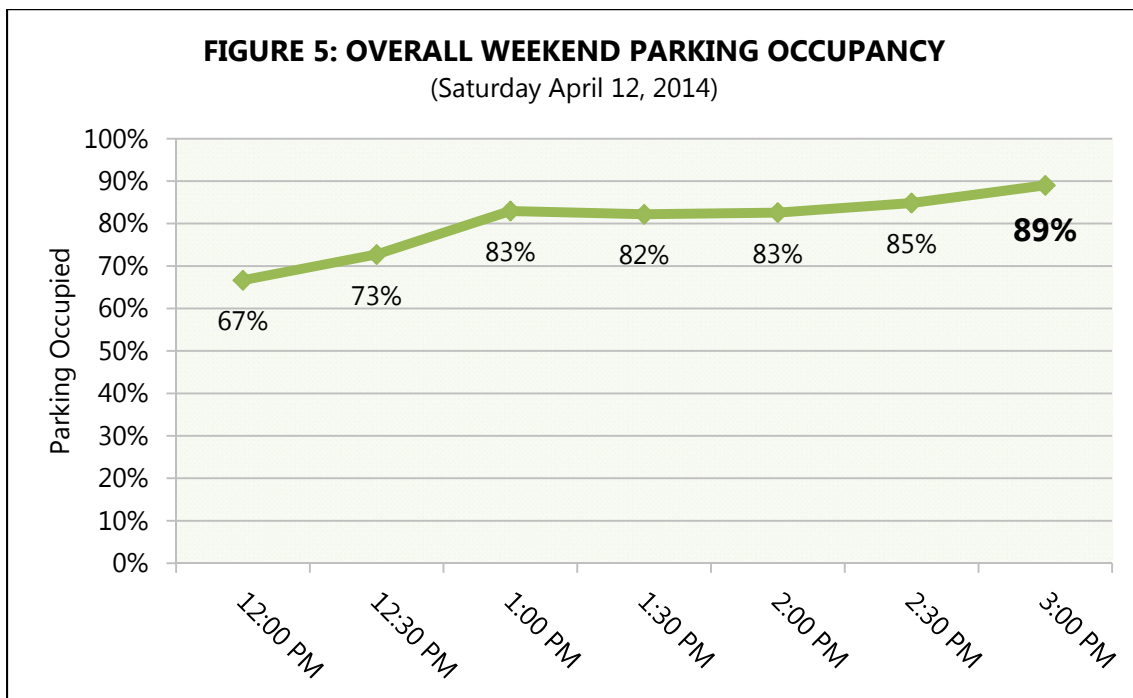

Source: Fehr & Peers, 2014

Bicycle Parking

Bicycle parking demand was also assessed during the parking survey. An average of four (4) bikes were parked in the racks near the Community Center on weekdays. An average of ten (10) bikes were parked in the racks near the Community Center on Saturdays. The racks were fullest on weekdays between 3:00 and 5:00 PM. On Saturdays, the racks were fullest between 1:30 and 3:00 PM.



Unmet Demand

The peak surveyed parking demand exceeds the supply indicating that there is an unmet parking need (also referred to as latent demand). In order to calculate the unmet need, additional parking surveys were conducted to specifically answer the following questions:

- When both the North and South Lots are full, how many vehicles circulate the lots in search of parking (also known as cruising for parking)?
- How many users park off-site and walk on foot to access the Civic Center?

Parking Demand by Use: Library and City Hall

Table 1 displays the weekday Civic Center parking demand by user for each hour between 11:00 AM and 6:00 PM, by use. Below are the definitions of each user group studied along with the key assumptions associated with each of their parking behaviors.

- **City Employees:** This user group includes employees of the City of Cupertino who work on-site at City Hall or park at City Hall and use a City vehicle to access their work site(s). This includes City Employees who park in the on-street spaces along Rodrigues Avenue (specifically delineated for City Hall between the hours of 7:00 AM to 5:00 PM). Based on the Civic Center Parking Survey (2014), the majority of City Hall employees arrive at the site before 8:30 AM. About 64 percent of employees leave the Civic Center by car to go to lunch between 12:00 PM and 2:00 PM (Civic Center Parking Survey, 2014). Some of the employees carpool to off-site lunch destinations. Occupancy in the North Lot decreases after lunch. Most employees leave after 5:30 PM, at which time the occupancy in the North Lot decreases and more spaces become available to other users.
- **City Visitors:** This user group includes visitors who come to City Hall because they are City employed contractors, vendors, or members of the public in need of assistance (e.g., permits, meetings, other services) . The average number of visitors per hour was calculated from data from the Civic Center Parking Survey (2014).
- **Library Users:** This user group includes Library employees and visitors. In general, the library is busiest after school hours when students are looking for a place to do homework or study. Community Hall users are included in this group as their parking demand could not be discerned from the library parking demand.
- **Non-Site Users:** The library opens on 10:00 AM on weekdays, thus any users parked in this lot before then who are not employees of the Library or City Hall are assumed to be non-users. They are parking on the site and then walking to a destination not associated with the Civic Center, such as a nearby restaurant, medical office, or office building for the



duration of the workday. Non-users tend to park in the southwest corner of the South Lot in the spaces close to Torre Avenue. Thus, this user groups consists of people who should not be parking at the Civic Center. These people could be deterred by stricter parking enforcement, as parking at the Civic Center is intended for users of the site.

- **Total Surveyed:** This variable captures the total demand of the City Employees, City Visitors, Library Users and Non-Site Users.
- **Latent Demand:** Latent demand consists of demand that exceeds what can be accommodated at the site. It includes users who circulate the parking lots when all spaces are full, in search of parking. Based on field observations conducted with the North and South Lots were fully occupied between 2:30 and 3:00 PM on Thursday, April 14, about five (5) motorists at a time cruise for parking. The circling tends to focus on the Book Drop spaces. (Most of these users were observed parking for a few minutes to drop off or pick up books from the library.) This user group also includes people who approach the site on foot.
- **Grand Total:** The grand total includes all user groups described above (including Latent Demand).

Separating the demand by user group helps to better understand the timing and needs of different users, as the site serves a variety of uses that vary by time of day and activity. City Hall parking demand is depicted both in **Table 1** and in **Figure 6**. City Hall demand peaks or reaches its maximum at 11:00 AM. Library (and Community Hall) parking demand is depicted both in **Table 1** and in **Figure 7**. Library use peaks at 1:00 PM and 4:00 PM (generally coinciding with after-school activities). The number of City Hall visitors peaks between 9:30 AM and 11:30 AM, with an average of three visitors to City Hall. Non-Site users are expected to generally stay parked during the day, decreasing at about 5:00 PM when general business hours end. Latent demand peaks when the demand for all other users surveyed maximizes. At this time, occupancy is at its highest and finding a parking space at the Civic Center is difficult because of the limited supply.



TABLE 1: WEEKDAY CIVIC CENTER PARKING DEMAND, BY USER GROUP

Time	City Employees	City Visitors	Library and Community Hall Users	Non-Site Users	Total Surveyed	Latent Demand	Grand Total
11:00 AM	88	3	152	10	253	23	276
12:00 PM	68	2	168	10	248	25	273
1:00 PM	65	2	172	10	249	26	275
2:00 PM	85	1	158	10	254	29	283
3:00 PM	80	1	163	10	254	31	286
4:00 PM	75	1	171	10	257	33	290
5:00 PM	50	0	168	10	228	24	252
6:00 PM	40	0	162	4	206	15	221
Maximum Demand	88	3	172	10	257	33	290

Note: Includes parking spaces in North and South Lots and in designated off-street spaces.
 Source: Fehr & Peers, 2014.

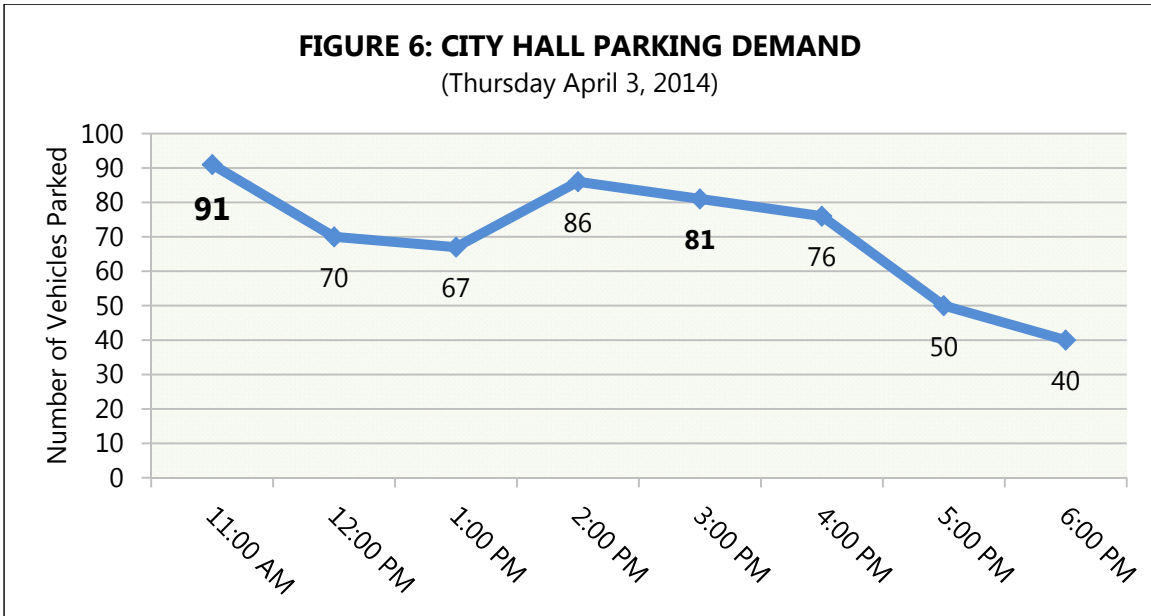

Source: Fehr & Peers 2014

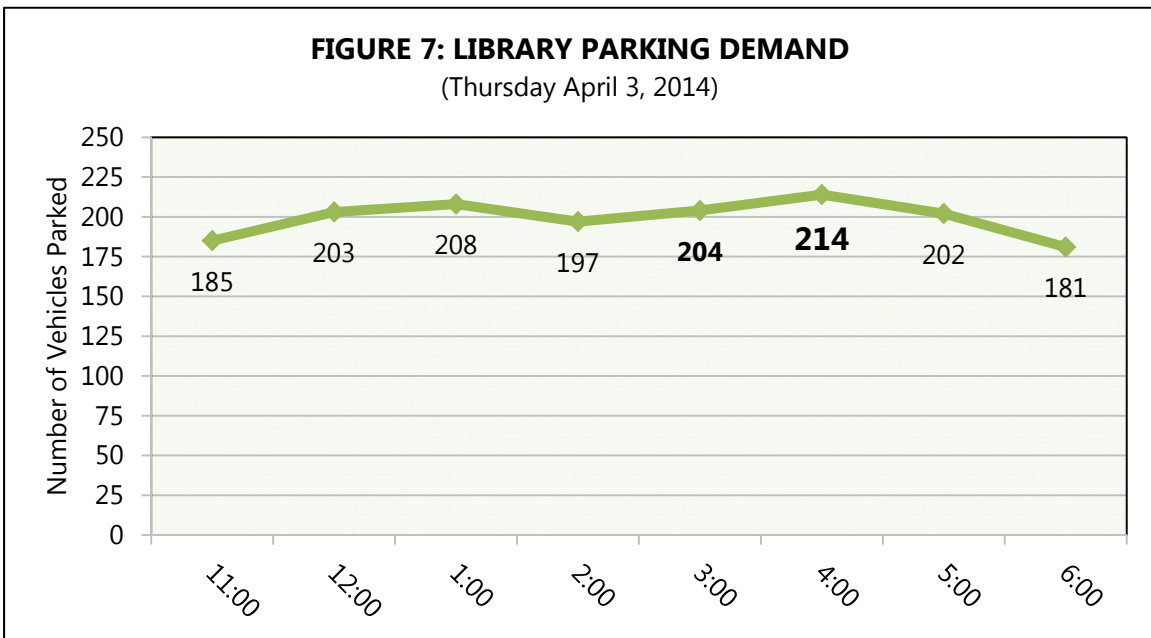

Source: Fehr & Peers, 2014



RECOMMENDED PARKING SUPPLY

The parking supply should exceed the peak parking demand to allow parkers to find spaces without excessive circulation. City Hall demand was calculated by summing the following uses: City Employees and City Visitors. Library demand was calculated by summing the following uses: Library, Non-Site, and Latent Demand. A circulation factor of five (5) percent was added to the City Hall uses and ten (10) percent was added to the Library Uses. The recommended parking supplies for City Hall and Library Uses (by hour) are displayed in **Table 2**. The total recommended supply is the sum of recommended supply for City Hall and Library during the site peak at 4:00 PM, a total of 315 parking spaces. The current unmet need is the difference between total recommended supply and the existing supply (315 – 269), which equates to 46. Thus, the current unmet need at the Civic Center in the peak period (4:00 PM) is 46 spaces.

This estimate is based on low-attendance events occurring at the Community Hall and on Library Field during the weekday afternoons. If higher-attendance events are regularly scheduled, the unmet need could increase. Alternatively, the unmet need could be reduced by 11 spaces if the non-site users were required to move. This could be done through enforcement and instituting parking time limits.

CONCLUSIONS

Based on the parking demand surveys, the Civic Center parking supply (on and off-street) has a utilization rate of 97 percent. Although both of these rates suggest available supply, supplemental analysis shows that the current unmet need at the site is 46 spaces. The unmet need could be reduced to 35 spaces if the non-site users were required to move through enforcement and/or instituting parking time limits. However, greater shortages could occur if high-attendance Community Hall or Library Field events coincide with peak parking times.



TABLE 2: RECOMMENDED EXISTING CIVIC CENTER PARKING SUPPLY

Time	City Hall		Library/Community Hall		Total Recommended Supply
	Demand	Recommended Supply	Demand	Recommended Supply	
11:00 AM	91	96	185	204	299
12:00 PM	70	74	203	223	297
1:00 PM	67	70	208	229	299
2:00 PM	86	90	197	217	307
3:00 PM	81	85	204	224	309
4:00 PM	76	80	214	235	315
5:00 PM	50	53	202	222	275
6:00 PM	40	42	181	199	241
Maximum Demand	91	96	214	235	315

Note: Includes parking spaces in North and South Lots and in designated off-street spaces.
 Source: Fehr & Peers, 2014.

This page intentionally left blank.

APPENDIX A - 07

Infrastructure: Existing Conditions Summary Memo
(BKF, May 13, 2014)

BKF No. 20145034-10
Cupertino Civic Center Master Plan & Parking Study
May 13, 2014

EXISTING CONDITIONS SUMMARY

PURPOSE

The Cupertino Civic Center block bounded by Rodrigues Avenue to the north, Pacifica Drive to the south, Torre Avenue to the west and Regnart Creek to the east is being studied in anticipation of construction of new parking facilities, a new city hall, and new community facilities. The purpose of this memo is to document the existing characteristics of the onsite utilities and existing boundaries and easements located on the property as they relate to the planning of these future improvements.

METHODOLOGY & EXISTING IMPROVEMENTS

The Civic Center area being studied with this project currently contains City Hall, built in 1965 and renovated in 1986, a library and community hall built in 2004, a public plaza, sports field with a cricket court, and parking facilities.

Construction documents and AutoCAD files provided to BKF from these improvements, including demolition and construction documents from the most recent projects, were examined and compiled as possible to create an approximation of the existing improvements on-site. Neither a field verification survey, nor a utility survey was performed.

Available record map documents were also examined in order to document the existing boundary conditions and recorded easements believed to be active within the project limits. No boundary survey, ALTA survey, or resolution was performed.

Prior to commencement of design for any selected projects, we recommend that a current title report be obtained and an updated site survey and utility location survey be conducted to document current conditions of the site.

EXISTING LOT LINES & EASEMENTS

Based on the documents available, the project area currently consists of five separate parcels. The largest, northern parcel contains all of the existing buildings. Future buildings would need to be located such that a single structure would not occupy more than one parcel. Alternatively, it may be necessary to record a lot line adjustment to move any lines that conflict with future buildings.

The project study area contains multiple utility easements across its five parcels, a fire service easement, and an easement in favor of the Santa Clara Valley Water District (SCVWD) along the eastern edge of the entire site. Some utility easements are occupied by various active utility lines; some do not appear to be occupied. None of the easements appear to be items that would be immovable. If any easements are still required but will occupy space required by future facilities, they could be relocated as needed and recorded.

In addition to the easement in favor of the SCVWD, SCVWD policies state that the agency will need to review and permit any construction plans adjacent to the 5' easement and an encroachment permit would be required. The District will not allow construction of any sort within the 5' easement.

EXISTING UTILITIES

Currently, most utilities are served to the library, community hall and City Hall from Torre Avenue. City Hall has connections both to Torre and to Rodrigues. There are at least four existing storm drain outfalls from the site to the neighboring Regnart Creek. Most utilities and easements on-site serve only the project study area and do not cross over to serve neighboring parcels. One exception to this may be a PG&E easement and service that crosses from Torre to Regnart Creek. The service is underground through the site and is overhead across the Creek to Farallone Drive. Although this line may serve adjacent areas, this does not preclude the possibility of relocation of the line on-site in coordination with PG&E.

For any utilities that lie within and are associated with recorded easements, relocation of the utilities may require coordination with other agencies and will likely require recordation of new easements once new placement has been determined.

This page intentionally left blank.

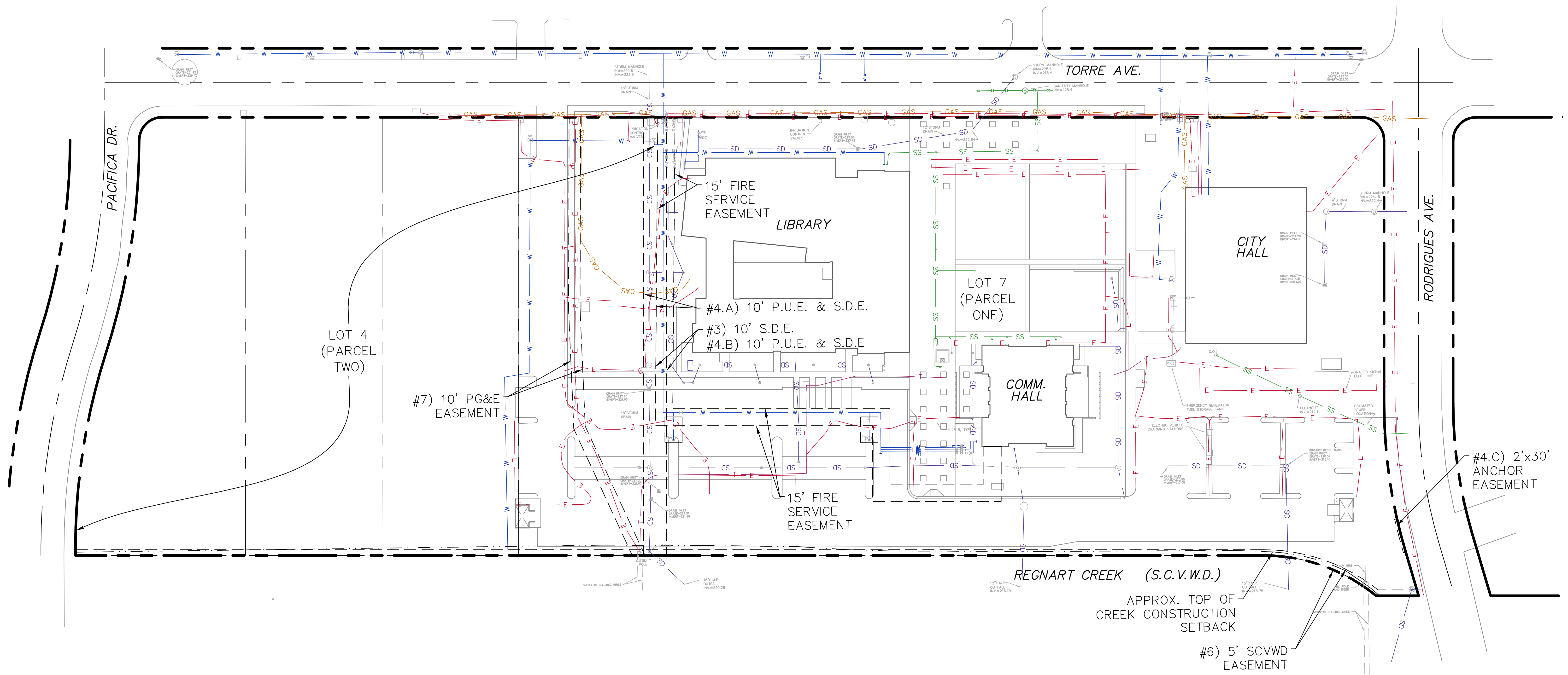

UTILITY LINE LEGEND

W	WATER
GAS	NATURAL GAS
E	ELECTRICAL
SD	STORM DRAIN
SS	SANITARY SEWER
T	COMMUNICATION

BOUNDARY LEGEND

---	PROPERTY LINE
---	ON-SITE PROPERTY LINE
---	ROADWAY CENTER LINE
---	EASEMENT
---	APPROXIMATE CREEK SETBACK

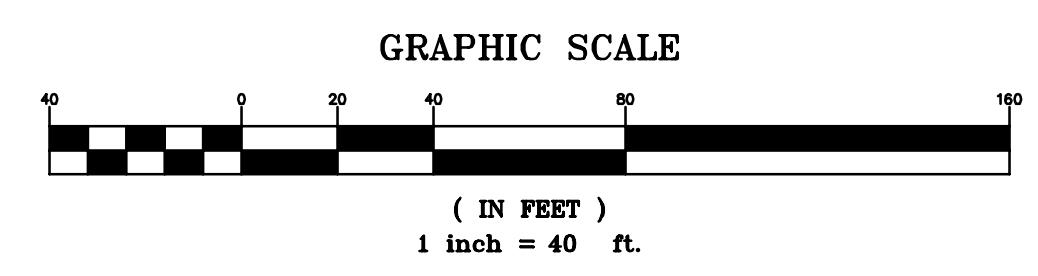
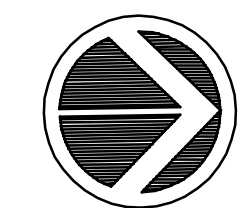

CUPERTINO CIVIC CENTER
 MASTER PLAN & PARKING STUDY
 10800 TORRE AVENUE, CUPERTINO, CA

EXISTING CONDITIONS

BKF
 ENGINEERS | SURVEYORS | PLANNERS
 4670 WILLOW ROAD, SUITE 250
 PLEASANTON, CA 94588-3323
 TEL: (925) 396-7700
 FAX: (925) 396-7799

JOB NO. 20145034-10
DATE 04-01-14

EXHIBIT

This page intentionally left blank.

APPENDIX A - 08

Arborist Report (Deborah Ellis, MS., Jan 2, 2015)



ARBORIST REPORT

Project:

Cupertino Civic Center Master Plan & Parking Garage Conceptual Planning
Cupertino Civic Center, Torre, Rodrigues & Pacific Drive, Cupertino, California

Property Owner:

City of Cupertino

Prepared for:

Carmen Lynaugh
City of Cupertino Public Works Department
10300 Torre Avenue,
Cupertino, CA 95014

Prepared by:

Deborah Ellis, MS.

Consulting Arborist & Horticulturist

Registered Consulting Arborist #305, American Society of Consulting Arborists
Board Certified Master Arborist WE-0457B, International Society of Arboriculture
Certified Professional Horticulturist #30022, American Society for Horticultural Science

JANUARY 2, 2015

©Deborah Ellis, 2015. This report may be reproduced in whole or in part by only the client and the client's authorized representatives and only for use with the subject project and/or property. All other reproduction requires the expressed written or verbal consent of Deborah Ellis prior to reproduction.

PO Box 3714, Saratoga, CA 95070. 408-725-1357. dec@pacbell.net. <http://www.dec@pacbell.com>.





Table of Contents

TREE MAP #1 Complete Complex 1

TREE MAP #2 North Complex 2

TREE MAP #3 South Complex 3

SUMMARY 4

Brief Description of the Project 4

Plans/Documents Reviewed 4

Brief Description of the Trees 4

Species Composition & Number 5

Tree Condition 6

RECOMMENDATIONS 7

APPENDIX 9

TABLE 1 Complete Tree Table 9

Explanation of Tree Table Data Columns: 30

Supporting Information 32

Purpose & Use of Report 32

Methodology 32

Observations 33

Tree Protection Distances 34

3 to 5 x DBH 34

OTPZ (Optimum Tree Protection Zone) 34

Tree Photos 35

Assumptions & Limitations 39

Glossary 42

Cover photo: corner of Rodrigues and Torre Avenues. The tree row of **Chinese pistache trees #101-116** is visible. All photos in this report were taken by D. Ellis between December 23, 2014 and January 2, 2015.

PO Box 3714, Saratoga, CA 95070. 408-725-1357. decah@pacbell.net. <http://www.decac.com>.



TREE MAP #1 COMPLETE COMPLEX



Note that separate, larger copies of the Tree Maps in this report have also been provided as .PDF files, along with an online interactive .KMZ file.



TREE MAP #2 NORTH COMPLEX





TREE MAP #3 SOUTH COMPLEX



PO Box 3714, Saratoga, CA 95070. 408-725-1357. decab@pacbell.net. <http://www.decab.com>.



SUMMARY

BRIEF DESCRIPTION OF THE PROJECT

A master plan is being developed for the renovation of the Cupertino Civic Center. A new parking structure may be part of the renovation.

PLANS/DOCUMENTS REVIEWED

- Aerial map of the site, no date, presumed 2012, that includes numbered tree locations (#1 through #395) that corresponds to a database of the existing trees on the site, updated in 2012.

BRIEF DESCRIPTION OF THE TREES

There are 412 trees on the project site. These trees are described in the Complete Tree Table (Table 1) beginning on page 9. No Tree Disposition Recommendations (e.g. Save, Remove or Debatable) are provided in this report because construction plans have not yet been developed. The tree Preservation Suitability ratings and Tree Root Protection Distances will be helpful to the project planners and architects however, in deciding which trees to retain and how far improvements should be located from these trees, during the design process. Out of the 412 evaluated trees:

- **Two-hundred, sixty-four (264) trees are classified as having “Excellent”, “Good” or “Fair/Good” preservation suitability.** These are the better trees on the site, and those that are most worthy of retaining or transplanting. These trees comprise 64% of the total tree population on the site.
- **Eighty-two (82) trees are classified as having “Fair” preservation suitability.** These are “so-so” trees and I do not recommend going through too much trouble to retain them. They make up 20% of the trees on the site.
- **Sixty-four (64) trees are classified as having “Fair/Poor”, “Poor” or “Unacceptable” preservation suitability.** I would not put any effort into retaining any of these trees, which are the remaining 16% of the trees on the site.



As the construction plans for the project are developed I recommend that I review these plans and produce additional reports describing the expected impact of construction on those trees that will remain. I can also work with the architects to reduce construction impacts to trees where possible. I can eventually prepare a Final Arborist Report listing trees to remain, trees to be removed and Tree Protection Specifications for those trees that will remain.

SPECIES COMPOSITION & NUMBER

There are 17 species of trees growing on the site, as indicated in Table 2 below:

Species	Total number of Trees	Percentage of total
Chinese pistache, <i>Pistacia chinensis</i>	149	36.2%
black acacia, <i>Acacia melanoxylon</i>	76	18.4%
honey locust, <i>Gleditsia triacanthus inermis</i>	44	10.7%
coast redwood, <i>Sequoia sempervirens</i>	33	8.0%
deciduous flowering pear, <i>Pyrus calleryana</i>	28	6.8%
cherry, flowering. <i>Prunus x yedoensis</i> 'Akebono'	15	3.6%
river birch, <i>Betula nigra</i>	15	3.6%
Brazilian pepper, <i>Schinus terebinthifolius</i>	12	2.9%
European olive, <i>Olea europaea</i>	8	1.9%
camphor tree, <i>Cinnamomum camphora</i>	6	1.5%
cape myrtle, <i>Lagerstroemia indica</i>	5	1.2%
Calif. sycamore, <i>Platanus racemosa</i>	4	1.0%
coast live oak, <i>Quercus agrifolia</i>	4	1.0%
red maple, <i>Acer rubrum</i>	4	1.0%
sawleaf zelkova, <i>Zelkova serrata</i>	4	1.0%
Marina hybrid madrone, <i>Arbutus</i> 'Marina'	3	0.7%
black walnut, <i>Juglans californica hindsii</i>	2	0.5%
Total Trees	412	100.0%

★ ★

★

★ Indicates species native to the immediate area.

PO Box 3714, Saratoga, CA 95070. 408-725-1357. decah@pacbell.net. <http://www.decah.com>.



TREE CONDITION

Most of the trees on site have good vigor and fair or fair/good structure. The main tree problems noted were:

- **Chinese pistache trees:** **girdling roots**¹ and **multiple attachments of scaffold branches**.
- **Honey locust:** many are infected with a trunk **canker disease** that appears to be worsening on these relatively young trees; so their prognosis is probably not good.
- **Black acacias** adjacent to the parking lot: branch breakage over the parking lot, root damage to curb and asphalt where planting area is narrow and tree trunks are close to pavement.
- **Coast redwoods:** probable suffering from drought stress
- **Many other tree species:** lack of young tree training pruning, leading to structural defects that are easily correctable now on young trees, but more difficult on older, larger trees.
- **Too low planting of some trees**, e.g. Chinese pistache, flowering cherries, honey locusts in lawns, trees in the gold fines plaza in near the Library on Torre Avenue. Some of these trees look like they are planted in "bowls". This could lead to **root rot disease** in the future.
- **Staff parking lot:** trees planted in narrow island planters are or are likely to cause significant pavement damage.

You may contact me for help with the above problems, which is beyond the scope of my work for this tree survey and arborist report.

¹ Terms **highlighted** at their first occurrence in this report are explained in the **Glossary on pages 42 through 44**.



RECOMMENDATIONS

1. **Which trees to retain?** Try to design around and retain as many of trees as possible with "Good" and "Fair/Good" preservation suitability ratings. Trees with "Fair" preservation suitability should be saved when possible, but I don't recommend making a significant effort to save them. No effort should be made to retain trees with "Fair/Poor" or "Poor" preservation suitability. Trees recommended for further evaluation by the arborist should be evaluated in greater detail if they may remain. If no further evaluation will be performed on these trees then it is probably best to remove these them for reasons of safety.
2. **I should review all site-based plans for this project:** Improvements will cause trees to be impacted and/or removed. Examples of important plans to review are: the Existing and Proposed Site Plan, Demolition, Construction Staging, Erosion Control, Grading & Drainage, Underground Utilities, Landscaping & Irrigation, Building Elevations & Sections, Roof Plan and Construction & Landscape Details showing improvements that may impact trees. Plans reviewed by the arborist should be full-size, to-scale and with accurately located tree trunks and canopy driplines relative to proposed improvements. Scale should be 1:20 or 1:10.
3. **As a part of the design process, try to keep proposed improvements (and any additional over-excavation or work area beyond the improvement) as far from tree trunks and canopies as possible.** 5xDBH² or the dripline of the tree, whichever is greater, should be used as the minimum distance for any soil disturbance to the edge of the trunk. 3xDBH should be considered the absolute minimum distance from any disturbance to the tree trunk on one side of the trunk only, for root protection. Farther is better, of course. For disturbances on multiple sides of the trunk, then 5xDBH or greater should be used, and farther is also better here. Tree canopies must also be taken into consideration when designing around trees. Don't forget the minimum necessary working margin around improvements as you locate those improvements. Disturbance usually comes much closer to trees than the lines shown on the plans!
4. **New landscaping and irrigation can be as much or more damaging to existing trees than any other type of construction.** The same tree root protection distances recommended for general construction should also be observed for new landscaping. Within the root protection zone it is usually best to limit landscape changes to a 3 to 4-inch depth of coarse organic mulch such as wood or bark chips or free trimming chippings spread over the soil surface. The environment around existing trees should be changed very carefully or not at all – please consult with me regarding changes in the landscape around existing trees and/or have me review the landscape and irrigation plans for this project.
5. **Custom Tree Protection Specifications should be prepared** for any existing trees on this site that will be saved. I have not prepared such specifications at this time because it is too early in the planning process and we do not know which trees will be saved.

² 3 & 5xDBH: See page 34 for an explanation of these calculations which are used to estimate root protection distances for trees.



6. **Construction or landscaping work done underneath the dripline of existing trees should preferably be done by hand**, taking care to preserve existing roots in undamaged condition as much as possible and cutting roots cleanly by hand when first encountered, when those roots must be removed. A **qualified consulting arborist** (the **project arborist**) should be hired to monitor tree protection and supervise all work underneath the dripline of trees. This also applies to trees on neighboring properties whose canopies overhang the work site.
7. **Trees remaining after adjacent trees are removed** should be re-evaluated by the project arborist.
8. **General Tree Maintenance:**
 - a. **The root collars and lower trunks of a few of the trees were obscured from view by vegetation**. Such portions of the tree should be uncovered and the tree re-evaluated by the arborist.
 - b. **Do no unnecessary pruning, fertilization or other tree work**. Pre-construction pruning should be limited to the absolute minimum required for construction clearance. A **qualified tree service** should be hired to provide such pruning.



APPENDIX
TABLE 1 COMPLETE TREE TABLE

This Table is continued through page 29. Data fields in the Table are explained on pages 30 to 32.

Tree #	Alt #	Species & Common Name	Trunk Diam.	Size	CONDITION		Preservation Suitability	Notes	TREE ROOT PROTECTION DISTANCES		
					Vigor	Structure			3KDBH	5KDBH	OTFZ
1		Acacia melanoxylon, black acacia	15.4	35*25	80	60	Fair/Good	Black acacia trees #1-18 are adjacent to the grass playing field, and so pavement damage is not a concern with these trees.	4	6	12
2		black acacia	19	45*30	90	70	Good		5	8	19
3		black acacia	12.6	45*25	70	40	Fair/Poor	OK if kept in grove, as are other black acacias in this tree row with Fair preservation suitability.	3	5	9
4		black acacia	10.3	45*25	90	50	Fair		3	4	8
5		black acacia	12	40*20	80	50	Fair		3	5	9
6		black acacia	10	30*20	80	60	Fair/Good		3	4	8
7		black acacia	13	45*18	80	60	Fair	There is a significant crook in the trunk where a previous co-dominant leader broke out.	3	5	10
8		black acacia	16.4	50*40	90	40	Fair/Poor		4	7	12
9		black acacia	1,1,1	12*5	80	40	Fair/Poor	A stump sprout with 3 sucker trunks. Could make a good tree if 2 suckers removed and tree maintained as single trunk. Tree number tag is 12 inches above the ground due to small trunk size.	3	4	5
10		black acacia	3,3	17*7	80	40	Fair/Poor	Same as previous except number tag is at normal height on trunk.	3	4	5
11		black acacia	5	25*12	85	80	Good		3	4	5
12		black acacia	14.9	45*25	80	50	Fair		4	6	11
13		black acacia	13.3	35*30	85	60	Fair/Good		3	6	10
14		black acacia	13.8	40*30	90	40	Fair/Poor	A large co-dominant scaffold branch failed on the creek side.	3	6	10

Deborah Ellis, MS

Consulting Arborist & Horticulturist



Tree #	Alt #	Species & Common Name	Trunk Diam.	Size	CONDITION		Preservation Suitability	Notes	TREE ROOT PROTECTION DISTANCES		
					Vigor	Structure			3xDBH	5xDBH	OTZ
15		black acacia	15	40*20	70	20	Poor	Two large scaffold branch failures and resultant wound on trunk, which leans toward creek.	4	6	11
16		black acacia	14	40*30	70	40	Fair/Poor	A past large scaffold branch failure and resultant trunk wound.	4	6	10
17		black acacia	5	40*15	60	60	Fair		3	4	5
18		black acacia	16	45*30	75	40	Fair/Poor		4	7	12
19		black acacia	14.8	40*25	70	50	Fair	This tree is the first tree in this black acacia tree row with its trunk adjacent to pavement (the parking lot) and also a portion of its canopy over the parking lot, as do subsequent black acacias through #43. The planting area in which these trees are located is narrow -- with tree trunks very close to the pavement - often less than 12 inches from the curb. Pavement damage and branch breakage over the parking lot is a concern for these trees.	4	6	11
20		black acacia	12	30*18	60	50	Fair/Poor		3	5	9
21	94	black acacia	8.7	18*10	0	0	Unacceptable	Large car impact wound at trunk base.	3	4	7
22	93	black acacia	11	26*20	70	40	Fair/Poor		3	5	8
23	92	black acacia	4	16*6	40	20	Poor		3	4	5
24	91	black acacia	8.6	30*18	70	50	Fair		3	4	6
25		black acacia	15.5	35*35	80	50	Fair	Trunk close to curb and contacting cars.	4	6	12
26		black acacia	11	35*25	75	40	Fair/Poor		3	5	8
27		black acacia	9.2	22*22	80	70	Fair		3	4	7
28	87	black acacia	5.9	18*10	40	40	Poor		3	4	5
29		black acacia	7.2	20*15	50	60	Fair		3	4	5
30	85	black acacia	9	25*20	60	45	Fair/Poor	Large scaffold tear wound parking lot side.	3	4	7
31		black acacia	2	13*4	70	60	Fair	This tree is a sucker growing from an old large root of a previous tree that was removed.	3	4	5
32	83	black acacia	4.3	18*10	80	70	Fair	Another stump sprout.	3	4	5

PO Box 3714, Saratoga, CA 95070. 408-725-1357. decah@pacbell.net. <http://www.decah.com>.

Deborah Ellis, MS

Consulting Arborist & Horticulturist



Service since 1984

Tree #	Alt #	Species & Common Name	Trunk Diam.	Size	CONDITION		Preservation Suitability	Notes	TREE ROOT PROTECTION DISTANCES		
					Vigor	Structure			3xDBH	5xDBH	OTPN
33	82	black acacia	8.7	40*18	80	50	Fair/Poor	Tree topped in the past and leans. Roots causing significant pavement damage. This is another stump sprout tree.	3	4	7
34	81	black acacia	13.8	45*25	70	60	Fair	Basal trunk wound (caused by cars) and significant curb and pavement damage.	3	6	10
35	80	black acacia	8.9	25*16	85	50	Fair/Poor	Major car-caused trunk wound and pavement damage. This tree looks like it is a sucker growing from a previously removed tree.	3	4	7
36	79	black acacia	8.8	22*22	60	50	Fair/Poor		3	4	7
37		black acacia	12.9	35*25	50	50	Fair/Poor		3	5	10
38		black acacia	10.1	37*22	70	60	Fair	Trunk wound from car, and curb damage caused by roots.	3	4	8
39		black acacia	12.3	35*35	70	60	Fair	Curb damage caused by roots.	3	5	9
40		black acacia	10.9	42*25	75	60	Fair		3	5	8
41		black acacia	2.5	16*5	75	60	Fair	Stump sprout tree.	3	4	5
42		black acacia	9.7	22*18	80	70	Fair		3	4	7
43		black acacia	7.4	16*12	70	45	Fair/Poor	Long trunk canker; probably from a previous wound.	3	4	5
44		black acacia	17 (3.5)	25*25	75	50	Fair	From here on the planting area for black acacia trees #44 through #60 is wider than previous black acacias #19 - 43. In this larger planting area most of the black acacia trees are farther back from pavement than previous black acacias #19 - 43, so pavement damage is not as much of a problem.	4	7	13
45		black acacia	10.3	28*20	60	60	Fair		3	4	8
46		black acacia	8.6	16*10	60	20	Poor	The back (creek) side of the trunk is largely decayed.	3	4	6
47	39	black acacia	11.6	28*22	80	60	Fair/Good		3	5	9
48	38	black acacia	10.2, 6	35*25	60	40	Fair/Poor	Edge of trunk 4 feet from curb.	3	6	10
49	37	black acacia	17.4	40*30	80	60	Fair/Good	Edge of trunk 5.5 feet from curb.	4	7	13
50		black acacia	15.2	28*25	70	50	Fair	Edge of trunk 8 feet from curb.	4	6	11

PO Box 3714, Saratoga, CA 95070. 408-725-1357. decah@pacbell.net. <http://www.decah.com>.

Deborah Ellis, MS

Consulting Arborist & Horticulturist



Tree #	Alt #	Species & Common Name	Trunk Diam.	Size	CONDITION		Preservation Suitability	Notes	TREE ROOT PROTECTION DISTANCES		
					Vigor	Structure			3xDBH	5xDBH	OTPN
51	34	black acacia	10.7	30*22	70	50	Fair	Edge of trunk 8 feet from curb.	3	4	8
52	33	black acacia	11.4	38*20	70	50	Fair	Edge of trunk 8 feet from curb.	3	5	9
53	32	black acacia	12.3	25*18	60	40	Poor	A previous tree fell on this tree and its canopy is not severely leaning.	3	5	9
54	30	black acacia	12.8	35*25	60	60	Fair		3	5	10
55	29	black acacia	11.1	28*12	0	0	Unacceptable		3	5	8
56	38	black acacia	12.1	30*30	80	60	Fair/Good	Trunk below scaffolds at 3 feet includes 2 sub-trunks of about 18 inches in diameter each.	3	5	9
57		black acacia	9.8, 7, 7.5, 8.5 (4)	25*25	90	50	Fair	More like a large shrub.	5	9	16
58		black acacia	12.7	35*25	60	40	Fair/Poor		3	5	10
59	90	black acacia	18.9	38*30	75	50	Fair	Some dead lower branches due to shading.	5	8	19
60	89	black acacia	15.5	40*30	60	60	Fair		4	6	12
61	23	black acacia	17	50*20	60	40	Fair/Poor	Leans 20 degrees toward creek. Black acacias #61 through 75 are located in a "forest-like" area between the parking lot and Rodrigues Avenue. I saw many people walking on a foot worn trail through this area. Many of the black acacia trees here are suckers or seedlings from other, older acacia trees.	4	7	13
62		black acacia	20	60*40	70	50	Fair	The canopy of this black acacia as well as all subsequent black acacia trees through #75 do not overhang the parking lot.	5	8	20
63		black acacia	4.2	22*15	70	50	Fair/Poor	Sucker from a nearby larger tree.	3	4	5
64		black acacia	8.4	25*15	70	40	Poor	Topped underneath overhead power lines.	3	4	6
65		black acacia	13.8, 8	60*30	80	50	Fair		4	7	13
66		black acacia	3.8	35*10	60	50	Fair/Poor	Too close to other trees, and in general this area is overcrowded with trees.	3	4	5
67		black acacia	4	30*12	70	50	Fair/Poor	Same as previous.	3	4	5

PO Box 3714, Saratoga, CA 95070. 408-725-1357. decab@pacbell.net. <http://www.decab.com>.

Deborah Ellis, MS

Consulting Arborist & Horticulturist



Tree #	Alt #	Species & Common Name	Trunk Diam.	Size	CONDITION		Preservation Suitability	Notes	TREE ROOT PROTECTION DISTANCES		
					Vigor	Structure			3DBH	5XDBH	OTPN
68		black acacia	6.5	40*20	80	50	Fair	Multi-trunk stump sprout tree.	3	4	5
69		black acacia	7,6,6,5,4	25*18	80	40	Fair/Poor	A stump sprout tree from a previous 2 foot tall stump with octopus-like form.	4	8	14
70	93	black acacia	6.4	30*18	70	50	Fair		3	4	5
71	94	black acacia	3.4	16*9	70	50	Poor	Shaded understory tree only 3 feet from black acacia #70.	3	4	5
72	87	black acacia	17.2	45*35	70	60	Fair		4	7	13
73	88	black acacia	14.8	50*30	80	40	Poor	Ganoderma conk (fruiting body of a wood decay fungus) at root collar; tree could fall into parking lot.	4	6	11
74	86	black acacia	8.3, 3.5, 3	38*22	90	40	Fair/Poor	Smaller two trunks are suckers from the larger tree/trunk.	3	5	9
75	85	black acacia	6.1, 3.5	40*18	80	50	Fair		3	4	5
76	83	<i>Schinus terebinthifolius</i> , Brazilian pepper	7.2	28*20	70	40	Fair/Poor	Topped.	3	4	5
77	82	Brazilian pepper	11.3	25*25	90	50	Fair		3	5	8
78	96	Brazilian pepper	9.2	20*22	80	60	Fair/Good		3	4	7
79	95	Brazilian pepper	8.4	20*20	80	50	Fair		3	4	6
80		<i>Pyrus calleryana</i> , Pear - deciduous flowering	1.5	12*5	60	50	Fair	Unsure of vigor due to deciduous state. Planted too close to tree #78.	3	4	5
81		Pear - deciduous flowering	3	16*8	80	60	Fair/Good		3	4	5
82	99	Pear - deciduous flowering	4	18*10	80	60	Fair/Good		3	4	5
83		<i>Pistacia chinensis</i> , Chinese pistache	7.2	20*22	80	60	Fair/Good		3	4	5
84		Chinese pistache	9.2	20*20	70	60	Fair/Good		3	4	5

PO Box 3714, Saratoga, CA 95070. 408-725-1357. decab@pacbell.net. <http://www.decab.com>.

Deborah Ellis, MS

Consulting Arborist & Horticulturist



Tree #	Alt #	Species & Common Name	Trunk Diam.	Size	CONDITION		Preservation Suitability	Notes	TREE ROOT PROTECTION DISTANCES		
					Vigor	Structure			3DBH	5XDBH	OTPN
85		Chinese pistache	10.8	25*25	85	60	Good		3	5	6
86		Chinese pistache	7.7	20*20	85	60	Good		3	4	5
87		Chinese pistache	3	22*9	80	60	Good		3	4	5
88		Chinese pistache	5	18*18	85	60	Good	Has a one-inch girdling root.	3	4	5
89		Chinese pistache	12.2	20*25	90	60	Good		3	5	9
90		Chinese pistache	9.5	25*20	85	60	Good		3	4	5
91		Chinese pistache	9.1	30*25	80	60	Good		3	4	5
92		Chinese pistache	9.3	30*25	85	60	Good		3	4	5
93		Chinese pistache	8.3	22*22	80	70	Good		3	4	5
94		Chinese pistache	4.2	17*12	75	60	Fair/Good		3	4	5
95		Chinese pistache	8	30*25	90	60	Good	One potential girdling root is visible.	3	4	5
96		Chinese pistache	6.5	25*20	80	60	Good	A small potential girdling root is visible. Girdling roots unfortunately seem to be common on these Chinese pistache trees.	3	4	5
97		Chinese pistache	5.2	18*16	75	50	Fair/Good		3	4	5
98		Chinese pistache	5.2	8*3	60	50	Fair	Structure could be improved with pruning. Number tag is on stake, due to small trunk size.	3	4	5
99		Chinese pistache	7.3	25*22	80	60	Good		3	4	5
100		Chinese pistache	7.5	18*20	80	60	Good		3	4	5
101		Chinese pistache	6.8	20*20	80	60	Good		3	4	5
102		Chinese pistache	13.8	35*30	90	60	Good		3	6	10
103		Chinese pistache	8.6	30*22	85	70	Good		3	4	5
104		Chinese pistache	5.7	18*15	80	60	Good		3	4	5
105		Chinese pistache	4.7	16*14	80	50	Fair/Good		3	4	5
106		Chinese pistache	10.4	28*30	90	60	Good		3	4	5
107		Chinese pistache	8.1	18*22	80	60	Good		3	4	5
108		Chinese pistache	8	20*18	80	60	Good		3	4	5
109		Chinese pistache	11.3	20*22	85	60	Good		3	5	6

PO Box 3714, Saratoga, CA 95070. 408-725-1357. decah@pacbell.net. <http://www.decah.com>.

Deborah Ellis, MS

Consulting Arborist & Horticulturist



Service since 1984

Tree #	Alt #	Species & Common Name	Trunk Diam.	Size	CONDITION		Preservation Suitability	Notes	TREE ROOT PROTECTION DISTANCES		
					Vigor	Structure			3xDBH	5xDBH	OTPN
110		Chinese pistache	12.3	35*30	90	70	Good	Some girdling roots visible.	3	5	9
111		Chinese pistache	9.2	28*22	85	60	Good		3	4	5
112		Chinese pistache	9.5	28*30	90	60	Good		3	4	5
113		Chinese pistache	6.5	18*20	85	50	Fair/Good		3	4	5
114		Chinese pistache	9.3	25*25	80	40	Fair/Poor	Large scaffold failure tear wound down the trunk.	3	4	5
115		Chinese pistache	11	32*30	85	60	Good		3	5	6
116		Chinese pistache	7.1	18*20	80	60	Good		3	4	5
117		Chinese pistache	7.3	22*20	85	60	Good	Chinese pistache trees #117 - 126 are planting in 5x5 foot square cutout planters in pavement, with tree grates.	3	4	5
118		Chinese pistache	6.5	22*20	80	60	Good	Root collar touching tree grate.	3	4	5
119		Chinese pistache	6	20*20	80	70	Good		3	4	5
120		Chinese pistache	5.6	22*18	85	60	Good		3	4	5
121		Chinese pistache	6.6	22*25	90	60	Good	Trunk contacting tree grate.	3	4	5
122		Chinese pistache	7.2	22*25	85	60	Good	Trunk contacting tree grate.	3	4	5
123		Chinese pistache	6.4	20*18	75	60	Good		3	4	5
124		Chinese pistache	6.3	20*16	80	70	Good		3	4	5
125		Chinese pistache	4.7	18*16	70	60	Good		3	4	5
126		Chinese pistache	6.1	18*20	80	75	Good		3	4	5
127		Chinese pistache	5.8	22*22	85	70	Good	This and subsequent Chinese pistache trees through #151 are located in a lawn area.	3	4	5
128		Chinese pistache	6.5	22*22	90	60	Good		3	4	5
129		Chinese pistache	6.6	25*22	100	60	Good		3	4	5
130		Chinese pistache	4.9	20*22	85	50	Fair/Good		3	4	5
131		Chinese pistache	6.2	30*25	100	60	Good		3	4	5
132		Chinese pistache	6	28*25	100	60	Good		3	4	5
133		Chinese pistache	6.3	28*22	90	70	Good		3	4	5
134		Chinese pistache	4.5	25*20	90	60	Good		3	4	5

PO Box 3714, Saratoga, CA 95070. 408-725-1357. decah@pacbell.net. http://www.decah.com.

Deborah Ellis, MS

Consulting Arborist & Horticulturist



Tree #	Alt #	Species & Common Name	Trunk Diam.	Size	CONDITION		Preservation Suitability	Notes	TREE ROOT PROTECTION DISTANCES		
					Vigor	Structure			3xDBH	5xDBH	OTPr
135		Chinese pistache	4.8	25*20	80	70	Good		3	4	5
136		Chinese pistache	6.1	28*22	90	70	Good		3	4	5
137		Chinese pistache	6.7	20*20	85	70	Good		3	4	5
138		Chinese pistache	3.8	16*10	75	60	Good		3	4	5
139		Chinese pistache	5.1	20*18	85	70	Good		3	4	5
140		Chinese pistache	5.9	18*22	85	70	Good		3	4	5
141		Chinese pistache	5.5	20*20	80	70	Good		3	4	5
142		Chinese pistache	5.4	20*20	85	60	Good		3	4	5
143		Chinese pistache	4.8	16*18	85	70	Good		3	4	5
144		Chinese pistache	5.3	22*20	85	50	Fair/Good		3	4	5
145		Chinese pistache	6.6	20*22	90	60	Good		3	4	5
146		Chinese pistache	5.3	16*16	80	60	Good		3	4	5
147		Chinese pistache	5.9	22*22	100	60	Good		3	4	5
148		Chinese pistache	3.9	20*18	85	60	Good		3	4	5
149		Chinese pistache	3.5	17*12	85	60	Good		3	4	5
150		Chinese pistache	3.1	13*10	60	60	Fair/Good		3	4	5
151		Chinese pistache	3.8	18*15	80	60	Good	Several of these Chinese pistache trees in the lawn are planted too deeply; as in a shallow bowl/depression.	3	4	5
152		Chinese pistache	4.9	20*20	80	70	Good		3	4	5
153		Chinese pistache	5.2	20*16	85	70	Good		3	4	5
154		Chinese pistache	6.1	25*20	85	60	Good		3	4	5
155		Chinese pistache	10.6	30*35	85	75	Good		3	4	5
156	74	Chinese pistache	10.7	40*35	85	60	Good	Some small girdling roots visible.	3	4	5
157	76	Chinese pistache	10.2	40*30	85	70	Good		3	4	5
158		Chinese pistache	11	40*30	80	60	Good	Some girdling roots visible.	3	5	6
159		Chinese pistache	9.5	35*30	80	60	Good	Some girdling roots visible.	3	4	5
160		Chinese pistache	8.5	35*25	85	60	Good		3	4	5

PO Box 3714, Saratoga, CA 95070. 408-725-1357. decah@pacbell.net. http://www.decah.com.

Deborah Ellis, MS

Consulting Arborist & Horticulturist



Tree #	Alt #	Species & Common Name	Trunk Diam.	Size	CONDITION		Preservation Suitability	Notes	TREE ROOT PROTECTION DISTANCES		
					Vigor	Structure			3xDBH	5xDBH	OTPN
161		Chinese pistache	9.8	35*25	80	60	Good		3	4	5
162		Chinese pistache	8.4	35*25	85	60	Good		3	4	5
163		Chinese pistache	6.5	30*22	80	60	Good		3	4	5
164		Chinese pistache	7.5	30*22	85	60	Good		3	4	5
165		Chinese pistache	8.3	35*25	85	60	Good		3	4	5
166		Chinese pistache	8.3	30*25	80	60	Good		3	4	5
167		Chinese pistache	8.1	35*22	90	50	Fair/Good		3	4	5
168		Chinese pistache	8	40*25	80	70	Good		3	4	5
169		Chinese pistache	8.3	30*20	80	70	Good		3	4	5
170		Chinese pistache	7.1	30*22	70	60	Fair/Good	This tree is located in the lawn at the corner of Torre Avenue and Pacific Drive. There is a lot of foot traffic resulting in soil compaction and dead lawn grass around this tree.	3	4	5
171		Chinese pistache	9.2	30*30	80	60	Good		3	4	5
172		Chinese pistache	10.9	28*25	85	50	Fair	Prominent girdling roots and also co-dominant scaffolds with included bark .	3	5	6
173		Chinese pistache	7.3	22*20	70	50	Fair		3	4	5
174		Chinese pistache	9.5	28*30	85	60	Fair/Good	Many small girdling roots visible.	3	4	5
175		Chinese pistache	8.6	28*22	80	70	Good	Small girdling roots visible.	3	4	5
176		Chinese pistache	8	22*28	80	75	Good		3	4	5
177		Chinese pistache	7.5	25*22	85	60	Good		3	4	5
178		Chinese pistache	6.3	20*18	80	60	Good		3	4	5
179		Chinese pistache	8.6	30*22	80	60	Good	Some girdling roots visible. In general, these Chinese pistache trees all have multiple attachments of scaffold branches and girdling roots; whether or not the girdling roots are visible.	3	4	5
180		Chinese pistache	8.6	22*25	80	50	Fair/Good	Large scaffold branch failure and resultant wound.	3	4	5
181		Chinese pistache	9.2	30*22	85	50	Fair/Good	Potential girdling roots.	3	4	5

PO Box 3714, Saratoga, CA 95070. 408-725-1357. decah@pacbell.net. http://www.decah.com.

Deborah Ellis, MS

Consulting Arborist & Horticulturist



Tree #	Alt #	Species & Common Name	Trunk Diam.	Size	CONDITION		Preservation Suitability	Notes	TREE ROOT PROTECTION DISTANCES		
					Vigor	Structure			3xDBH	5xDBH	OTPN
182	77	Chinese pistache	7.8	28*20	80	70	Good		3	4	5
183	75	Chinese pistache	10	35*25	85	60	Good		3	4	5
184	73	Chinese pistache	9.5	35*30	90	50	Fair/Good	Girdling roots and a small tight vertical scaffold crotch with included bark.	3	4	5
185	72	Chinese pistache	9.8	35*30	85	60	Good		3	4	5
186		Chinese pistache	10	28*22	85	40	Fair/Poor	A large scaffold branch failure and tear down the trunk took out half the diameter of the trunk.	3	4	5
187		Chinese pistache	7.3	30*20	70	40	Fair/Poor		3	4	5
188		Chinese pistache	8.8	35*22	70	50	Uncertain	This tree may have some dead branches (because see abnormal peeling bark) but the buds growing from these branches look normal. The tree may have also partially uprooted; one side of the root plate is abnormally high and exposed. Recommend further investigation in late Spring/Summer.	3	4	5
189		Chinese pistache	6.7	30*25	80	60	Good		3	4	5
190		Chinese pistache	7	20*20	70	50	Fair/Good		3	4	5
191		Chinese pistache	9.9	35*22	85	60	Good		3	4	5
192		Chinese pistache	7.6	35*25	85	60	Good		3	4	5
193		Chinese pistache	11.5	35*40	90	60	Good		3	5	6
194		Chinese pistache	8.4	30*22	70	60	Good		3	4	5
195		Chinese pistache	7.3	20*20	70	50	Fair/Poor	The tree leans toward the street -- it looks like this is caused by girdling roots.	3	4	5
196		Chinese pistache	5.8	20*18	60	60	Fair/Good		3	4	5
197		Chinese pistache	9.3	20*22	80	70	Good		3	4	5
198		Chinese pistache	8.7	30*22	80	60	Good		3	4	5
199		Chinese pistache	8.3	30*25	80	60	Good		3	4	5
200		Chinese pistache	9.2	30*22	80	60	Good		3	4	5

PO Box 3714, Saratoga, CA 95070. 408-725-1357. decab@pacbell.net. <http://www.decab.com>.

Deborah Ellis, MS

Consulting Arborist & Horticulturist



Tree #	Alt #	Species & Common Name	Trunk Diam.	Size	CONDITION		Preservation Suitability	Notes	TREE ROOT PROTECTION DISTANCES		
					Vigor	Structure			3xDBH	5xDBH	OTZ
201		Chinese pistache	9.5	30*25	70	60	Good	Definite girdling roots including a 2 to 3-inch diameter root that could be cut.	3	4	5
202		Chinese pistache	6.7	30*25	80	60	Good		3	4	5
203		Chinese pistache	6.2	22*2	80	60	Good		3	4	5
204		Chinese pistache	7.1	22*20	80	60	Good		3	4	5
205		Chinese pistache	7.3	28*25	85	60	Good		3	4	5
206		Chinese pistache	8.3	30*22	85	60	Good		3	4	5
207		Chinese pistache	8.9	30*25	85	70	Good		3	4	5
208		Chinese pistache	7.4	25*22	75	70	Good		3	4	5
209		Chinese pistache	7	22*2	80	50	Fair/Good		3	4	5
210		Chinese pistache	7.4	30*22	70	60	Good		3	4	5
211		Chinese pistache	8	25*20	70	60	Fair/Good		3	4	5
212		Chinese pistache	10.1	32*30	90	50	Fair/Good		3	4	5
213		Chinese pistache	5.2	25*22	70	60	Good		3	4	5
214		Chinese pistache	10.8	32*28	80	50	Fair/Good		3	5	6
215		Chinese pistache	10.4	35*30	85	60	Good		3	4	5
216		Chinese pistache	8.5	28*22	60	60	Fair/Good	Some definitely dead branches with detached bark.	3	4	5
217		Chinese pistache	8.3	22*25	100	60	Good		3	4	5
218		Chinese pistache	5.7	22*20	70	60	Uncertain	Unsure about vigor -- see some peeling of bark on branches.	3	4	5
219		Chinese pistache	7.5	30*25	85	60	Good	Definite girdling roots.	3	4	5
220		Chinese pistache	6.2	18*20	80	70	Good		3	4	5
221		Chinese pistache	7.9	28*22	85	60	Good		3	4	5
222		Chinese pistache	8.5	22+28	85	60	Good		3	4	5
223		Chinese pistache	8.4	25*22	70	60	Good		3	4	5
224		<i>Juglans californica hindsi</i>	24.7	35*50	80	50	Fair/Good	This is an old, leaning tree with a prominent crook in the trunk and a cavity and decay at this point due to a previous leader that was removed or failed. This	6	10	31

PO Box 3714, Saratoga, CA 95070. 408-725-1357. decab@pacbell.net. <http://www.decab.com>.



Tree #	Alt #	Species & Common Name	Trunk Diam.	Size	CONDITION		Preservation Suitability	Notes	TREE ROOT PROTECTION DISTANCES		
					Vigor	Structure			3xDBH	5xDBH	OTPZ
		black walnut						walnut is probably an old orchard tree remnant. It is doing surprisingly well in the lawn area that was planted around it. This is a neat old tree that kids like to climb on. I saw one small clump of mistletoe in the canopy.			
225		black walnut	23.2	42*35	80	60	Fair/Good	Another old tree; probably an orchard remnant. A scaffold branch removal wound has left a relatively small area of decay on the trunk. Large surface roots in the lawn have been repeatedly shaved by lawn mowers. This tree as well, is doing surprisingly well for its location in a lawn.	6	10	29
226	56	Pear - deciduous flowering	7.2	35*18	90	50	Fair/Good	Multiple attachments of crowded upright branches in most of the pears on this site.	3	4	5
227		Pear - deciduous flowering	8.8	30*22	85	60	Good		3	4	5
228		Pear - deciduous flowering	5.6	25*16	80	60	Good		3	4	5
229	60	Pear - deciduous flowering	6.3	28*183	90	70	Good		3	4	5
230	63	Chinese pistache	10.1	35*25	80	45	Fair	Several long sunscaid cankers due to past branch removals.	3	4	5
231	64	Chinese pistache	8.3	22*20	80	70	Good		3	4	5
232	65	Chinese pistache	8.4	30*20	90	60	Good		3	4	5
233	66	Chinese pistache	7.1	18*20	85	60	Good		3	4	5
234	67	Chinese pistache	9.2	28*25	90	60	Good		3	4	5
235	68	Chinese pistache	10.6	32*28	80	60	Good	I saw a few branches where bark has flaked off. There is profuse sap flow down one side of the trunk; unsure of the cause.	3	4	5
236	69	Chinese pistache	9.2	28*25	100	60	Good	Several girdling roots growing over surface roots.	3	4	5

Deborah Ellis, MS

Consulting Arborist & Horticulturist



Tree #	Alt #	Species & Common Name	Trunk Diam.	Size	CONDITION		Preservation Suitability	Notes	TREE ROOT PROTECTION DISTANCES		
					Vigor	Structure			3xDBH	5xDBH	OTPN
237	70	Chinese pistache	6.2	18*16	80	60	Good		3	4	5
238		<i>Sequoia sempervirens</i> , coast redwood	16	45*22	60	70	Fair/Good	Coast redwoods #238 - 270 constitute a large grove of trees on the south side of the library building.	4	7	8
239		coast redwood	22.5	60*22	80	80	Good		6	9	17
240		coast redwood	21	60*20	80	80	Good		5	9	16
241		coast redwood	21.2	58*22	60	70	Fair		5	9	16
242		coast redwood	16.1	55*18	80	80	Good		4	7	8
243		coast redwood	9.4	40*16	80	75	Good		3	4	5
244		coast redwood	16.5	60*22	75	80	Good		4	7	8
245		coast redwood	9.1	30*18	50	60	Fair		3	4	5
246		coast redwood	17.1	45*22	60	60	Fair		4	7	8
247		coast redwood	23.3	60*22	60	70	Fair		6	10	17
248		coast redwood	24.8	60*25	70	70	Fair/Good		6	10	19
249		coast redwood	4.7	8*12	55	60	Fair		3	4	5
250		coast redwood	24.2	60*22	70	70	Fair/Good		6	10	18
251		coast redwood	20.7	45*20	70	60	Fair/Good		5	9	16
252		coast redwood	18.8	50*22	60	70	Fair		5	8	14
253		coast redwood	19.2	45*22	50	70	Fair		5	8	14
254		coast redwood	6.8	28*15	70	75	Fair/Good		3	4	5
255		coast redwood	10.4	40*16	70	75	Fair/Good		3	4	5
256		coast redwood	15.5	55*16	60	60	Fair		4	6	7
257		coast redwood	21.4	60*22	70	70	Fair/Good		5	9	16
258		coast redwood	14	60*18	60	60	Fair	An inner grove tree.	4	6	7
259		coast redwood	17.9	55*18	70	60	Fair/Good		4	7	8
260		coast redwood	16	50*18	60	70	Fair/Good		4	7	8
261		coast redwood	19.9	50*20	55	60	Fair		5	8	15
262		coast redwood	12.4	45*20	70	80	Fair/Good		3	5	6

PO Box 3714, Saratoga, CA 95070. 408-725-1357. decah@pacbell.net. <http://www.decah.com>.

Deborah Ellis, MS

Consulting Arborist & Horticulturist



Tree #	Alt #	Species & Common Name	Trunk Diam.	Size	CONDITION		Preservation Suitability	Notes	TREE ROOT PROTECTION DISTANCES		
					Vigor	Structure			3DBH	5XDBH	OTPN
263		coast redwood	19.8	60*18	60	50	Fair		5	8	15
264		coast redwood	19.6	55*20	60	50	Fair		5	8	15
265		coast redwood	23.3	65*25	60	60	Fair		6	10	17
266		coast redwood	20.9	60*22	50	50	Fair/Poor		5	9	16
267		coast redwood	22.4	55*22	50	50	Fair/Poor		6	9	17
268		coast redwood	23.4	60*25	55	60	Fair		6	10	18
269		coast redwood	24.7	65*25	50	60	Fair		6	10	19
270		coast redwood	27.7	60*25	50	60	Fair		7	12	21
271	62	Pear - deciduous flowering	17	35*30	80	60	Fair/Good		4	7	8
272	55	black acacia	4.9	18*15	90	50	Poor	The roots of this tree will soon break a 4-foot wide island planter in the parking lot, as well as surrounding pavement.	3	4	5
273		Pear - deciduous flowering	8.1	20*18	85	70	Good		3	4	5
274		Pear - deciduous flowering	5.5	18*10	85	70	Good		3	4	5
275		Pear - deciduous flowering	9.7	25*20	85	60	Fair/Good		3	4	5
276		Pear - deciduous flowering	6.3	18*15	85	60	Fair/Good		3	4	5
277		Pear - deciduous flowering	8	25*18	85	70	Good		3	4	5
278		Pear - deciduous flowering	9.1	25*22	85	70	Good		3	4	5
279		Pear - deciduous flowering	10.8	30*25	90	70	Good		3	5	6
280		Pear - deciduous flowering	9.6	25*22	85	70	Good		3	4	5

PO Box 3714, Saratoga, CA 95070. 408-725-1357. decah@pacbell.net. <http://www.decah.com>.

Deborah Ellis, MS

Consulting Arborist & Horticulturist



Tree #	Alt #	Species & Common Name	Trunk Diam.	Size	CONDITION		Preservation Suitability	Notes	TREE ROOT PROTECTION DISTANCES		
					Vigor	Structure			3xDBH	5xDBH	OTPr
281		Pear - deciduous flowering	8.6	22*20	85	70	Good		3	4	5
282		<i>Prunus x yedoensis</i> 'Akebono' cherry, flowering	6.3 (4)	20*12	85	70	Good	Flowering cherries #282 - 289 are all sunken into low planting "bowls" in the lawn area. Expect root rot disease in the future.	3	4	6
283		cherry, flowering	6 (4)	20*20	85	60	Fair/Good		3	4	5
284		cherry, flowering	7.9 (3.5)	20*20	90	70	Good		3	4	8
285		cherry, flowering	6.7 (3.5)	20*20	80	70	Good		3	4	6
286		cherry, flowering	6 (4)	16*12	80	60	Good		3	4	5
287		cherry, flowering	9.3 (4)	22*22	90	80	Good/Excellent		3	4	9
288		cherry, flowering	8.2 (4)	20*20	90	80	Good/Excellent		3	4	8
289		cherry, flowering	7.5 (4)	20*20	85	75	Good		3	4	7
290	54	<i>Betula nigra</i> , river birch	7.2	35*25	90	50	Fair/Good		3	4	5
291	53	river birch	7.2 (4)	40*22	90	70	Good		3	4	5
292	52	river birch	9	30*25	90	60	Fair/Good		3	4	7
293	51	river birch	10	35*22	90	70	Good		3	4	8
294	50	river birch	9.5 (4)	40*28	90	70	Good		3	4	7
295	49	river birch	8.1	40*25	90	60	Fair/Good		3	4	6
296	48	river birch	7	40*25	90	70	Good		3	4	5
297	47	river birch	6.7	45*30	85	60	Good		3	4	5
298	46	river birch	7.5	35*25	90	70	Good		3	4	5
299	45	river birch	7.5	36*25	90	70	Good		3	4	5
300	44	river birch	9.6 (4)	40*30	90	70	Good		3	4	7
301	43	river birch	7.8	40*25	90	60	Good		3	4	5
302	42	river birch	7.1	40*25	90	70	Good		3	4	5
303	41	river birch	7.4 (3.5)	35*22	90	70	Good		3	4	5

PO Box 3714, Saratoga, CA 95070. 408-725-1357. decab@pacbell.net. <http://www.decab.com>.

Deborah Ellis, MS

Consulting Arborist & Horticulturist



Service since 1984

Tree #	Alt #	Species & Common Name	Trunk Diam.	Size	CONDITION		Preservation Suitability	Notes	TREE ROOT PROTECTION DISTANCES		
					Vigor	Structure			3xDBH	5xDBH	OTZ
304	40	river birch	8.6	40*30	90	80	Good/Excellent		3	4	6
305		<i>Gleditsia triacanthos inermis</i> , honey locust	4.5	16*18	90	70	Good	Honey locust trees #305 - 318 are planted in 5x5-foot square cutout planters in pavement, with tree grates.	3	4	5
306		honey locust	4	18*18	90	70	Good		3	4	5
307		honey locust	3.4	16*10	80	70	Good		3	4	5
308		honey locust	3.5	16*12	85	60	Good		3	4	5
309		honey locust	3.4	16*10	80	70	Good		3	4	5
310		honey locust	3.5	18*12	80	60	Good		3	4	5
311		honey locust	4.2	18*18	85	60	Good		3	4	5
312		honey locust	4.3	20*18	80	80	Good		3	4	5
313		honey locust	3.7	17*15	80	60	Good		3	4	5
314		honey locust	3.7	16*14	80	55	Fair		3	4	5
315		honey locust	3.5	16*12	80	60	Good	Large scaffold branch tear down trunk.	3	4	5
316		honey locust	3	16*10	80	60	Good		3	4	5
317		honey locust	3.8	16*18	80	60	Fair/Good		3	4	5
318		honey locust	4.4	18*20	85	50	Fair	Large trunk wound and canker; may recover.	3	4	5
319		honey locust	4.6	18*20	90	70	Good	Honey locust #319 - 321 and 325 - 348 are planted in a lawn area. Most of the trees are planted low, in a "bowl". Weeds often fill the bowl and cover the root collar. Many of the trees have a trunk canker disease which should be sampled and diagnosed by a plant pathology lab. Most of the cankers are on the south side of the trunk, but some are on the north side. Many of these cankers may be predisposed by sunscald, but there is more going on here than just sunscald.	3	4	5
320		honey locust	3.6	18*16	80	50	Fair	Large trunk canker.	3	4	5

PO Box 3714, Saratoga, CA 95070. 408-725-1357. decab@pacbell.net. <http://www.decab.com>.

Deborah Ellis, MS

Consulting Arborist & Horticulturist



Tree #	Alt #	Species & Common Name	Trunk Diam.	Size	CONDITION		Preservation Suitability	Notes	TREE ROOT PROTECTION DISTANCES		
					Vigor	Structure			3xDBH	5xDBH	OTPr
321		honey locust	3.8	18*16	90	50	Fair	Trunk canker beginning.	3	4	5
322		honey locust	3.6	16*14	80	65	Good	Honey locusts #322 - 324 are located in 5x5-foot square planters in pavement with a tree grate, in a courtyard.	3	4	5
323		honey locust	3.3	16*15	80	70	Good		3	4	5
324		honey locust	3.5	18*16	80	70	Good		3	4	5
325		honey locust	3.8	18*14	85	60	Fair	This tree and subsequent honey locust trees through #348 are located in the same lawn area as #321-319. This tree (#325) has a canker on the south side of the trunk.	3	4	5
326		honey locust	4.2	18*16	80	50	Fair	Canker involves scaffold branches as well as trunk.	3	4	5
327		honey locust	3.4	15*10	70	45	Fair/Poor	Canker on multiple sides of trunk.	3	4	5
328		honey locust	3.4	18*12	70	45	Fair/Poor	Multiple numerous trunk cankers.	3	4	5
329		honey locust	3.6	18*14	80	60	Good		3	4	5
330		honey locust	3.7	18*15	60	40	Fair/Poor	Extensive trunk cankers.	3	4	5
331		honey locust	3.4	15*12	80	70	Good		3	4	5
332		honey locust	3.5	17*15	80	65	Good		3	4	5
333		honey locust	4.5	15*12	70	60	Fair	Trunk cankers small now, but will probably worsen.	3	4	5
334		honey locust	3.3	17*14	80	70	Good	Honey locust trees #334-336 in located in a bare soil planting area (no lawn) in a courtyard.	3	4	5
335		honey locust	3.5	18*16	85	65	Good		3	4	5
336		honey locust	3.8	18*16	85	70	Good		3	4	5
337		honey locust	3	16*12	80	60	Fair/Good	One bleeding spot on the lower trunk.	3	4	5
338		honey locust	3.4	16*12	85	60	Good		3	4	5
339		honey locust	3.7	15*12	70	55	Fair	Trunk cankers beginning.	3	4	5
340		honey locust	4	18*12	70	60	Fair	Trunk cankers.	3	4	5
341		honey locust	3.6	16*10	70	60	Fair		3	4	5
342		honey locust	3.4	12*8	70	60	Fair	Trunk cankers starting.	3	4	5

PO Box 3714, Saratoga, CA 95070. 408-725-1357. decab@pacbell.net. <http://www.decab.com>.

Deborah Ellis, MS

Consulting Arborist & Horticulturist



Tree #	Alt #	Species & Common Name	Trunk Diam.	Size	CONDITION		Preservation Suitability	Notes	TREE ROOT PROTECTION DISTANCES		
					Vigor	Structure			3xDBH	5xDBH	OTPN
343		honey locust	4.1	14*11	75	50	Fair/Poor	Large trunk cankers.	3	4	5
344		honey locust	3.4	18*12	70	50	Fair/Poor	Large trunk cankers.	3	4	5
345		honey locust	3.2	16*12	70	60	Fair	Trunk cankers.	3	4	5
346		honey locust	3.5	18*15	70	50	Fair/Poor	Large trunk cankers.	3	4	5
347		honey locust	2.9	16*8	70	50	Fair/Poor	Large trunk cankers.	3	4	5
348		honey locust	4.1	18*15	75	60	Fair	Trunk cankers	3	4	5
349	16	Brazilian pepper	8.9	20*18	80	70	Fair	This tree is planted in a 4-foot wide island planter with only minor root damage to the curb at this time.	3	4	7
350		Brazilian pepper	7.3	18*20	40	40	Poor	Canopy sparse. Large car wound to lower trunk, with decay.	3	4	5
351	1480	Pear - deciduous flowering	6	25*16	80	60	Fair/Good		3	4	5
352	13	Pear - deciduous flowering	5	18*10	80	40	Fair/Poor		3	4	5
353	12	Pear - deciduous flowering	2.1	10*6	60	40	Fair/Poor		3	4	5
354	11	<i>Cinnamomum camphora</i> , camphor tree	7.2	16*20	80	70	Fair/Poor	Located in 4-foot wide island planter (too large-growing a tree species for such a location).	3	4	7
355	10	camphor tree	10	20*22	90	50	Fair/Poor	Same as previous.	3	4	10
356	9	Brazilian pepper	10.5	15*16	70	70	Fair/Good	Foliage slightly chlorotic.	3	4	8
357	8	Brazilian pepper	5.9	16*14	75	60	Fair/Good		3	4	5
358	7	Pear - deciduous flowering	2.5	16*6	60	50	Fair		3	4	5
359	6	Pear - deciduous flowering	5.4	22*16	80	50	Fair/Good		3	4	5
360	5	Brazilian pepper	5.8	10*14	90	50	Fair	Flat-topped canopy.	3	4	5

PO Box 3714, Saratoga, CA 95070. 408-725-1357. decab@pacbell.net. <http://www.decab.com>.

Deborah Ellis, MS

Consulting Arborist & Horticulturist



Tree #	Alt #	Species & Common Name	Trunk Diam.	Size	CONDITION		Preservation Suitability	Notes	TREE ROOT PROTECTION DISTANCES		
					Vigor	Structure			3xDBH	5xDBH	OTZ
361	4	Brazilian pepper	16.1	22*25	60	50	Fair/Poor	Sparse canopy. Tool large-growing for the 4-foot wide island planter although no pavement damage yet.	4	7	16
362	3	Brazilian pepper	7.4	18*22	70	60	Fair/Good		3	4	5
363	1	Brazilian pepper	14.4	18*22	100	60	Fair/Poor	Same as previous, but significant damage to curb and pavement caused by roots.	4	6	11
364	22	Pear - deciduous flowering	13.1	35*30	80	60	Fair/Good		3	5	10
365	21	Pear - deciduous flowering	13.4	30*25	85	60	Fair/Good		3	6	10
366	20	Pear - deciduous flowering	13.1	32*30	85	50	Fair/Good		3	5	10
367	19	Pear - deciduous flowering	15.1	35*30	85	40	Fair/Poor	Large scaffold failure wound on trunk, plus a few small girdling roots.	4	6	11
368	19	Pear - deciduous flowering	14.5	40*35	70	60	Fair/Good		4	6	11
369	17	Pear - deciduous flowering	17.1	35*35	90	40	Fair/Poor		4	7	13
370		cherry, flowering	1	10*4\$	70	50	Fair	Basal trunk wound.	3	4	5
371		cherry, flowering	1	10*4	70	70	Fair/Good		3	4	5
372		cherry, flowering	7	10*15	70	40	Fair/Poor	Large trunk canker wound with decay.	3	4	7
373		cherry, flowering	3.4	8*3	20	20	Poor	A commemorative plaque reads, "Nancy's Tree".	3	4	5
374		cherry, flowering	3.9 (3)	6*10	70	60	Fair/Good		3	4	5
375		cherry, flowering	5.4 (2)	8*12	50	50	Fair/Poor	Many branch cankers and galls.	3	4	5
376		cherry, flowering	0.75	8*6	60	60	Fair		3	4	5
377		<i>Lagerstroemia indica</i> , crape myrtle	2.9	22*12	80	80	Good		3	4	5
378		crape myrtle	3.9	22*16	85	70	Good		3	4	5

PO Box 3714, Saratoga, CA 95070. 408-725-1357. decah@pacbell.net. <http://www.decah.com>.



Service since 1984

Tree #	Alt #	Species & Common Name	Trunk Diam.	Size	CONDITION		Preservation Suitability	Notes	TREE ROOT PROTECTION DISTANCES		
					Vigor	Structure			3xDBH	5xDBH	OTPr
379		crape myrtle	2.9	22*12	80	60	Good		3	4	5
380		crape myrtle	2.7	22*10	80	70	Good		3	4	5
381		crape myrtle	2.7	22*9	80	70	Good	Behind a locked gate, so unable to place number tag on trunk, or view tree from all sides.	3	4	5
382		Zelkova serrata, sawleaf zelkova	6.7	20*18	90	40	Fair/Poor		3	4	5
383		Arbutus 'Marina', Marina hybrid madrone	0.75 (4)	6*1.5	70	60	Fair/Good	A newly planted tree. Multiple attachments of scaffold branches should be corrected through young tree training pruning.	3	4	5
384		sawleaf zelkova	4.3	16*12	70	50	Fair	Multiple attachments of scaffold branches. One 1.5 inch diameter girdling root.	3	4	5
385		Platanus racemosa, Calif. sycamore	7.3	40*22	70	60	Fair/Good		3	4	5
386		Calif. sycamore	7.3	40*22	75	70	Fair/Good		3	4	5
387		Calif. sycamore	5	30*18	75	70	Fair/Good		3	4	5
388		Calif. sycamore	7	35*25	85	80	Good		3	4	5
389		Quercus agrifolia, coast live oak	7.2	18*16	60	70	Fair/Good		3	4	5
390		coast live oak	2.3	15*5	50	60	Fair	Planted in a deep "bowl", as our many of the trees in this gold fines plaza.	3	4	5
391		coast live oak	4.9	16*12	60	60	Fair		3	4	5
392		coast live oak	4.9	15*10	40	70	Fair	This tree was planted with its root ball too high! This may have something to do with its low vigor rating.	3	4	5
393		Acer rubrum, red maple	4.2	22*15	90	80	Good		3	4	5
394		red maple	4.9	20*16	80	70	Good		3	4	5

PO Box 3714, Saratoga, CA 95070. 408-725-1357. decah@pacbell.net. <http://www.decah.com>.

Deborah Ellis, MS

Consulting Arborist & Horticulturist



Tree #	Alt #	Species & Common Name	Trunk Diam.	Size	CONDITION		Preservation Suitability	Notes	TREE ROOT PROTECTION DISTANCES		
					Vigor	Structure			3xDBH	5xDBH	OTPN
395		red maple	4.2	22*18	80	60	Fair/Good		3	4	5
396		red maple	5.3	25*12	85	50	Fair/Poor	Long sunscald trunk cankers on the west side.	3	4	5
397		camphor tree	6.5	16*20	60	50	Fair	A few dead branches.	3	4	6
398		camphor tree	5.5	18*16	70	60	Fair/Good		3	4	5
399		camphor tree	4.2	15*12	70	60	Fair/Good		3	4	5
400		camphor tree	5.1	14*12	70	50	Fair		3	4	5
401		sawleaf zelkova	7	22*20	100	40	Fair/Poor	Crowded multiple attachments of scaffold branches -- like a broom.	3	4	5
402		sawleaf zelkova	6.9	25*22	85	40	Fair	Same as previous, although not quite as bad.	3	4	5
403		Marina hybrid madrone	6.8	16*15	60	60	Fair		3	4	5
404		Marina hybrid madrone	8.2	18*22	85	60	Fair/Good		3	4	6
405		Olea europaea, olive, European	5.8, 6.5, 7.3	20*25	90	70	Good		3	6	10
406		olive, European	5.8, 6.2, 6.8	20*20	85	80	Good		3	5	10
407		olive, European	2.0, 2.1, 3.2, 3.8	12*12	100	70	Good		3	4	5
408		olive, European	10.9, 1.2, 2.1, 3.8, 3.9	16*14	100	60	Fair/Good		4	7	12
409		olive, European	8.0, 8.9	20*22	100	75	Good		3	5	10
410		olive, European	4.9, 6.2, 6.8	20*20	85	70	Good		3	5	9
411		olive, European	4.5, 7.0, 6.8	20*20	90	70	Good		3	5	10
412		olive, European	5.0, 5.2, 7.0	18*18	85	60	Fair/Good	Some sunscald cankers on upper side of scaffold branches.	3	5	9

PO Box 3714, Saratoga, CA 95070. 408-725-1357. decah@pacbell.net. <http://www.decah.com>.



EXPLANATION OF TREE TABLE DATA COLUMNS:

- 1) **Tree Number** (the field tag number of the existing tree). Each existing tree in the field is tagged with a 1.25 inch round aluminum number tag that corresponds to its tree number referenced in the arborist report, Tree Map, Tree Protection Specifications and any other project plans where existing trees must be shown and referenced. I have used the same numbers as were shown in the aerial map of the site which corresponds to the previous tree database for the site, provided to me by the City of Cupertino.
- 2) **Alt. Number:** (Alternate Number) a numbered tree tag that had been placed on the tree prior to the survey, in addition to the tag number that is referenced in this report (first column on the left in the Tree Tables).
- 3) **No Tag:** if a tree's number is underlined, this means that I did not place a number tag on the trunk because it was too difficult to access, or the tree trunk was too small to nail into.
- 4) **Tree Name and Type:**
Species: The *Genus* and *species* of each tree. This is the unique scientific name of the plant, for example *Quercus agrifolia* where *Quercus* is the Genus and *agrifolia* is the species. The scientific names of plants can be changed from time to time, but those used in this report are from the most current edition of the *Sunset Western Garden Book* (2012) Sunset Publishing Corporation. The scientific name is presented at its first occurrence in the Tree Table, along with the regional common name. After that only the common name is used.
- 5) **Trunk diameter:** Tree trunk diameter in inches "at breast height" (DBH) measured at 4.5 feet above ground level. This is the forestry and arboricultural standard measurement height that is also used in many tree-related calculations. It is also the trunk diameter measurement height required by the City of Cupertino. For multi-trunk trees, trunk diameter is measured for the largest trunk and estimated for all smaller trunks. A number in parentheses (3) after the trunk diameter(s) indicates that it was not possible to measure the trunk at 4.5 feet (due to tree architecture) and so the diameter was measured at this alternate height (in feet), which reflects a more realistic trunk diameter for the tree.
- 6) **Size:** tree size is listed as height x width in feet, estimated and approximate and intended for comparison purposes.
- 7) **Condition Ratings:** Trees are rated for their *condition* on a scale of *zero to 100* with zero being a dead tree and 100 being a perfect tree (which is rare – like a supermodel in human terms). A 60 is "average" (not great but not terrible either). There are two components to tree condition – **vigor** and **structure**, and each component is rated separately. Averaging the two components is not useful because a very low rating for either one could be a valid reason to remove a tree from a site -- even if the other component has a high rating. Numerically speaking for each separate component:

100 is equivalent to *Excellent* (an `An` academic grade), **80** is *Good* (B), **60** is *Fair* (C), **40** is *Poor* (D), **20** is *Unacceptable* (F) and **0** is *dead*.



8) Relative to the scope of work for this report, tree Condition has been rated but not explained in detail and recommendations for the management of tree condition have not been included. The tree owner may contact Deborah Ellis for additional information on tree condition and specific recommendations for the general care of individual trees relative to their condition.

9) The *Condition* of the tree is considered relative to the tree species and present or future intended use of the site to provide an opinion on the tree’s Preservation Suitability Rating (i.e. “Is this tree worth keeping on this site, in this location, as explained in Table 3 below. This is based upon the scenario that the tree is given enough above and below-ground space to survive and live a long life on the site. Ratings such as “Fair/Good” and “Fair/Poor” are intermediate in nature. The Preservation Suitability rating is not always the same as the Condition Rating because (for example) some trees with poor condition or structure can be significantly improved with just a small amount of work – and it would be worthwhile to keep the tree if this were done.

Table 3 Preservation Suitability Rating Explanation

Excellent	Such trees are rare but they have unusually good health and structure and provide multiple functional and aesthetic benefits to the environment and the users of the site. These are great trees with a minimum rating of “Good” for both vigor and structure. Equivalent to academic grade ‘A’.
Good	These trees may have some minor to moderate structural or condition flaws that can be improved with treatment. They are not perfect but they are in relatively good condition and provide at least one significant functional or aesthetic benefit to the environment and the users of the site. These are better than average trees equivalent to academic grade ‘B’.
Fair	These trees have moderate or greater health and/or structural defects that it may or may not be possible to improve with treatment. These are “average” trees – not great but not so terrible that they absolutely should be removed. The majority of trees on most sites tend to fall into this category. These trees will require more intensive management and monitoring, and may also have shorter life spans than trees in the “Good” category. Retention of trees with moderate suitability for preservation depends upon the degree of proposed site changes. Equivalent to academic grade ‘C’.
Poor	These trees have significant structural defects or poor health that cannot be reasonably improved with treatment. These trees can be expected to decline regardless of management. The tree species themselves may have characteristics that are undesirable in landscape settings or may be unsuitable for high use areas. I do not recommend retention of trees with low suitability for preservation in areas where people or property will be present. Equivalent to academic grade ‘D’.
None	These trees are dead and/or are not suitable for retention in their location due to risk or other issues. In certain settings however, (such as wilderness areas, dead trees are beneficial as food and shelter for certain animals and plants including decomposers. Equivalent to academic grade ‘F’.



10) **Notes:** This may include any other information that would be helpful to the client and their architects and contractors within the scope of work for this report, such as a more detailed explanation of tree condition or expected construction impact.

11) **Tree Protection Distances** (See page 34).

a) Root Protection:

- i) **3 and 5xDBH:** Both the 3 and 5xDBH distances are listed for each tree. For multi-trunk trees 100% of the DBH of the largest trunk is added to 50% of the DBH for all other trunks in order to compute the operational DBH to use for these the Tree Protection Distance calculations. For practical purposes, the minimum 3xDBH distance is 3 feet and the minimum 5xDBH distance is 4 feet. If disturbance cannot be kept at least 3 feet from the trunk of a tree, the tree should normally be removed.
- ii) **OTPZ (Optimum Tree Protection Zone):** This is calculated as per the text, *Trees & Development*, Matheny et al., International Society of Arboriculture, 1998. This method takes into account tree age and the particular tree species tolerance of root disturbance. Because it may not be possible to maintain the OPTZ distance recommended for trees on many projects due to crowded site conditions, the Arborist may omit this requirement and list only the 3 and 5xDBH distances.

b) Canopy Protection: Additional space beyond root zone protection distances may be necessary for canopy protection.

SUPPORTING INFORMATION

PURPOSE & USE OF REPORT

This survey and report was required by the City of Cupertino as a part of the planning process for this project. The purpose of the report is to identify and describe the existing trees on site - - their size, condition and suitability for preservation. The audience for this report is the City of Cupertino and their project architects and others that are working on the Master Plan Project for the Civic Center and Parking Garage. The goal of this report is to preserve existing trees on site that are in acceptable condition, are good species for the area and will fit in well with the proposed new use of the site.

METHODOLOGY

I performed a **basic evaluation** of the subject trees between December 16 and 31, 2014. Tree characteristics such as form, weight distribution, foliage color and density, wounds and indicators of decay were noted. Surrounding site conditions were also observed. Evaluation procedures were taken from:



- Guide for Plant Appraisal, 9th edition, 2000, authored by the Council of Tree and Landscape Appraisers (CTLA) and published by the International Society of Arboriculture (ISA).
- Species Classification and Group Assignment published by the Western Chapter of the International Society of Arboriculture (WCISA), 1992.

The above references serve as industry professional standards for tree and landscape evaluations.

The trees were tagged in the field with metal number tags that correspond with the tree numbers referenced in this report and on the Tree Map. There are a few trees I was not able to tag, and these are indicated in the Tree Table. I measured the trunk diameter of each tree with a diameter tape at 4.5 feet above the ground (DBH), which is also the required trunk diameter measurement height of the City of Cupertino. DBH is used calculate tree protection distances and other tree-related factors. I estimated the tree's height and canopy spread. Tree Condition (structure and vigor) was evaluated and I also recorded additional notes for trees when significant. Tree species and condition considered in combination with the current or (if applicable) proposed use of the site yields the Tree Preservation Suitability rating. The major groupings of trees were photographed with a digital camera. Some of these photos are included in this report, but all photos are available from me by email if requested.

OBSERVATIONS **SITE CONDITIONS**

The Cupertino Civic Center complex is a beautiful site that is heavily landscaped. Landscape maintenance is of a high level. Site topography is mainly level. Sun exposure for the trees varies from full to partly shaded, depending upon proximity to existing buildings and to other trees.



TREE PROTECTION DISTANCES

3 TO 5 X DBH

No one can estimate and predict with absolute certainty how far a soil disturbance such as an excavation must be from the edge of the trunk of an individual tree to affect tree stability or health at a low, moderate or severe degree -- there are simply too many variable involved that we cannot see or anticipate. 3xDBH however, is a reasonable "rule of thumb" minimum distance (in feet) any excavation should be from the edge of the trunk *on one side of the trunk*. This is supported by several separate research studies including (Smiley, Fraedrich, & Hendrickson 2002, Bartlett Tree Research Laboratories. DBH is trunk "diameter at breast height" (4.5 feet above the ground). This distance is often used during the design and planning phases of a construction project in order to estimate root damage to a tree due to the proposed construction. It tends to correlate reasonably well with the *zone of rapid taper*, which is the area in which the large *buttress roots* (main support roots close to the trunk) rapidly decrease in diameter with increasing distance from the trunk. For example, using the 3X DBH guideline an excavation should be no closer than 4.5 feet from the trunk of an 18-inch DBH tree. Such distances are guidelines only, and should be increased for trees with heavy canopies, significant leans, decay, structural problems, etc. It is also important to understand that in actual field conditions we often find that much less root damage occurs than was anticipated by the guidelines. 3xDBH may be more of an aid in preserving tree stability and not necessarily long-term tree health. 5X DBH or greater is the "preferred" minimum distance which should be strived for, and this distance or greater should probably be used when there are multiple trenches on more than one side of the trunk. The roots beyond the zone of rapid taper form an extensive network of long, rope-like roots one to two inches in diameter. These woody perennial roots are referred to as *transport roots* because they function primarily to transport water and minerals. Maintaining a 5xDBH tree protection zone or greater around a tree will preserve more of these transport roots, which will have less of an impact on tree health than if the excavation were closer to the trunk.

OTPZ (OPTIMUM TREE PROTECTION ZONE)

OTPZ is the distance in feet from the trunk of the tree, all around the tree, that construction or other disturbance should not encroach within. If this zone is respected, then chances of the tree surviving construction disturbance are very good. This method takes into account tree age, DBH and the particular species tolerance to root disturbance. Although there are no scientifically based methods to determine the minimum distance for construction (for example, root severance) from trees to assure their survival and stability, there are some guidelines that are often used in the arboricultural industry. The most current guideline comes from the text, Trees & Development, Matheny et al., International Society of Arboriculture, 1998. The tree protection zone calculation method in this text was used to obtain the OTPZ's provided in this report. Due to the crowded, constrained nature of many building sites it is often not possible to maintain the OPTZ distance recommended for many of the trees -- therefore I have also listed alternate distances of 3 and 5X DBH (*see paragraph above*).



TREE PHOTOS

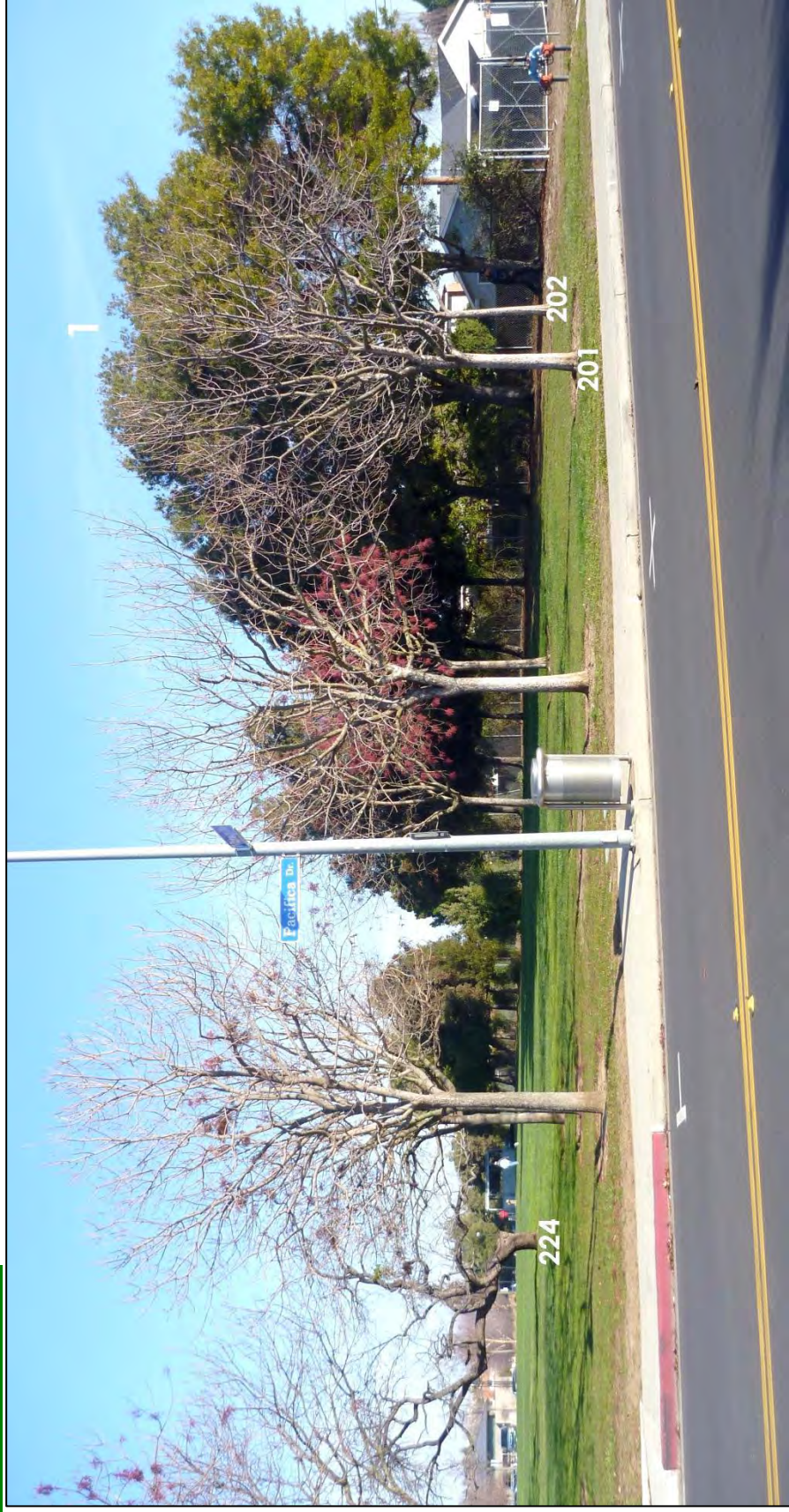

Pacifica Drive (foreground) with the creek perimeter at right. Tree numbering begins with the row of black acacia trees starting with tree #1. In the foreground is a double row of Chinese pistache trees including trees #201 and 202. Old black walnut #224 is in the background at left.

Deborah Ellis, MS

Consulting Arborist & Horticulturist



Service since 1984

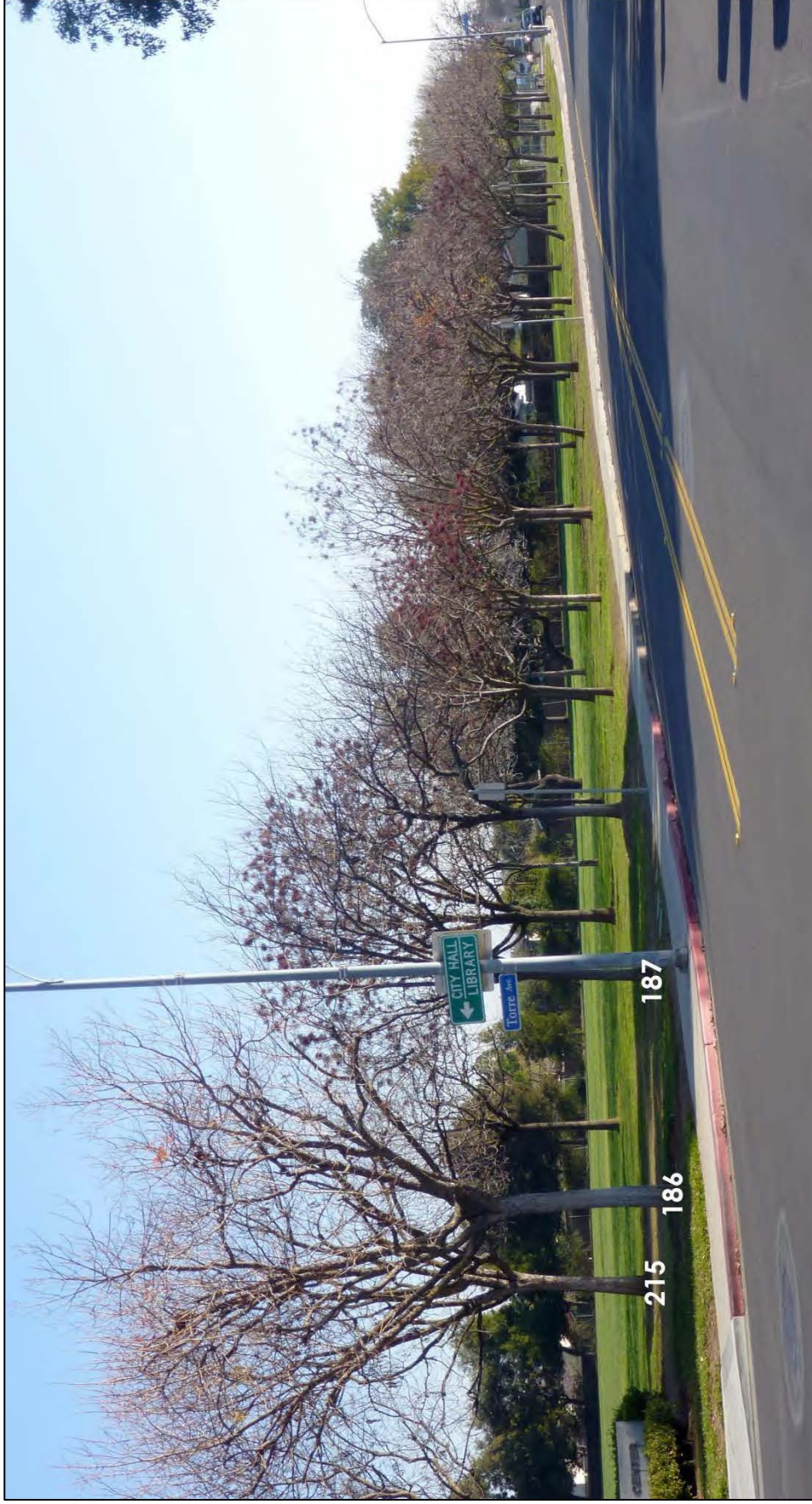

The corner of Pacifica Drive (right, foreground) with Torre Avenue to the left. The triple row of Chinese pistache trees is visible, with trees #186, 187 and 215 labeled.

PO Box 3714, Saratoga, CA 95070. 408-725-1357. decah@pacbell.net. <http://www.decah.com>.

Deborah Ellis, MS

Consulting Arborist & Horticulturist



Service since 1984



Rodrigues Avenue looking toward Torre Avenue to the right (not visible in photo). **Black acacia #69** is labeled, as is **Brazilian pepper #79** and **Chinese pistache #83**.

PO Box 3714, Saratoga, CA 95070. 408-725-1357. decah@pacbell.net. <http://www.decah.com>.

Arborist Report for Cupertino Civic Center Master Plan. January 2, 2015.

Deborah Ellis, MS

Consulting Arborist & Horticulturist



Service since 1984

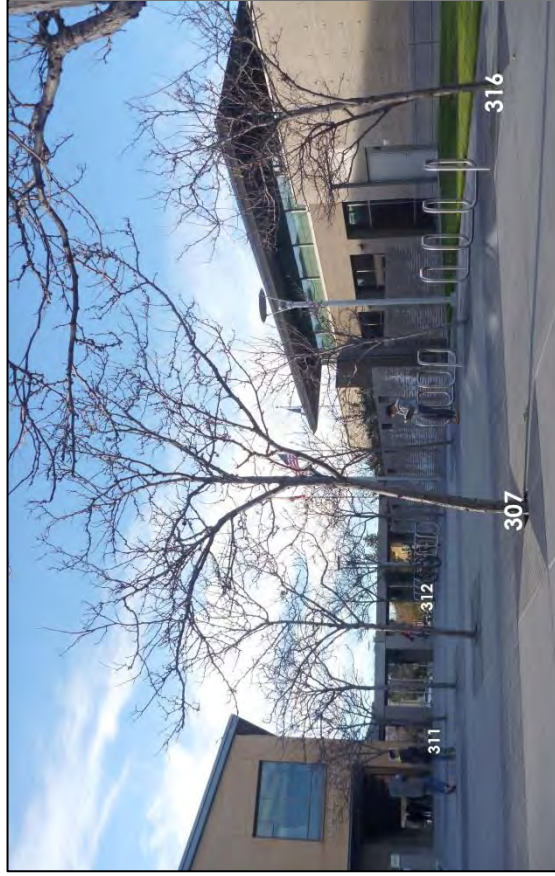
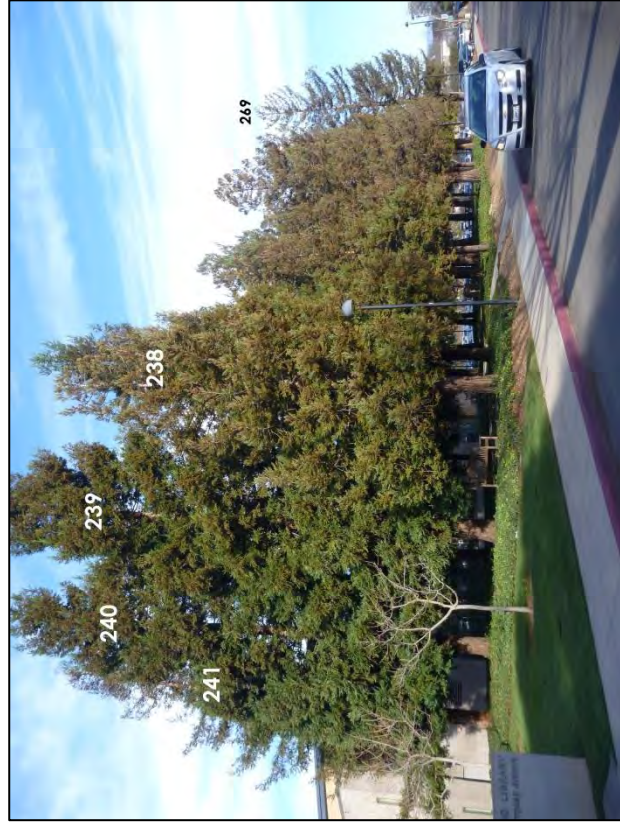

Upper Left: the grove of **coast redwoods #238-270** on the south side of the Library building.

Upper Right: **river birch trees #290 – 304** planted in a bioswale in the Library parking lot.

Lower Left: **honey locust trees #307 – 316** on the east side of the Library.

Lower Right: I am pointing to a trunk canker on a honey locust tree trunk.

PO Box 3714, Saratoga, CA 95070. 408-725-1357. decah@pacbell.net. <http://www.decah.com>.



ASSUMPTIONS & LIMITATIONS

- 1) **Tree locations** were originally from the City of Cupertino (via the aerial map showing numbered tree locations that I was provided). When I began the tree survey in the field however, I found that most of the tree number tags were missing, and the number tags did not match Cupertino's list of trees. I therefore did not use Cupertino's map or tree list, and conducted a new tree survey marking tree locations with a handheld GPS unit. I also tagged all trees with new number tags, but noted any old number tags as "Alternate numbers" in the Tree Table. Old number tags were removed from the trees.
- 2) **The Condition Ratings for deciduous trees that are out of leaf (because they have shed their leaves for winter dormancy) are estimated.** More accurate condition ratings for these trees can be obtained after they have fully leafed out (usually mid-May through September). Deciduous trees on this site that were completely leafless or in the process of shedding their leaves during my evaluation are listed below:

black walnut, <i>Juglans californica hindsii</i>
Calif. sycamore, <i>Platanus racemosa</i>
cherry, flowering. <i>Prunus x yedoensis</i> 'Akebono'
Chinese pistache, <i>Pistacia chinensis</i>
crape myrtle, <i>Lagerstroemia indica</i>
deciduous flowering pear, <i>Pyrus calleryana</i>
honey locust, <i>Gleditsia triacanthos inermis</i>
river birch, <i>Betula nigra</i>
red maple, <i>Acer rubrum</i>
sawleaf zelkova, <i>Zelkova serrata</i>

- 3) **A Basic Evaluation of the subject trees described in this report was performed between December 16 and 31, 2014 for the purpose of this report.** A basic evaluation is a visual evaluation of the tree from the ground, without climbing into the tree or performing detailed tests such as extensive digging, boring or removing samples. This is an initial screening of the tree after which the evaluator may recommend that additional, more detailed examination(s) be performed if deemed necessary.



- 4) **A few trees had their root collars and or lower trunks covered with soil, vegetation or debris** and were obstructed from view when I conducted my tree evaluation. The obstructions should be removed and I should re-examine these previously covered areas.
- 5) **The Arborist should review all site-based plans for this project relative to potential tree impacts, including plans not yet prepared and plans that are revised.** Plans reviewed by the arborist should be full-size, to-scale and with accurately located tree trunks and canopy driplines relative to proposed improvements. Scale should be 1:20 or 1:10.
- 6) **Any information and descriptions provided to me for the purpose of my investigation in this case and the preparation of this report are assumed to be correct.** Any titles and ownerships to any property are assumed to be good and marketable. I assume no responsibility for legal matters in character nor do I render any opinion as to the quality of any title.
- 7) **The information contained in this report covers only those items that were examined** and reflects the condition of those items at the time of inspection.
- 8) **Loss or removal of any part of this report** invalidates the entire report.
- 9) **Possession of this report, or any copy thereof,** does not imply right of publication for use for any purpose by any person other than to whom this report is addressed without my written consent beforehand.
- 10) **I take no responsibility for any defects in any tree's structure.** My fee is in no way contingent upon the reporting of a specified value or upon any finding or recommendation reported.
- 11) **This report has been prepared in conformity with generally acceptable appraisal/diagnostic/reporting methods and procedures** and is consistent with practices recommended by the International Society of Arboriculture and the American Society of Consulting Arborists.
- 12) **My evaluation of the trees that are the subject of this report is limited to visual examination of accessible items without dissection, excavation, probing or coring.** There is no warranty or guarantee, expressed or implied, that problems or deficiencies of the plants or property in question may not arise in the future.
- 13) **I take no responsibility for any defects in any tree's structure.** No tree described in this report has been climbed and examined from above the ground, and as such, structural defects that could only have been discovered have not been reported, unless otherwise stated. Structural defects may also be hidden within a tree, in any portion of a tree. Likewise, root collar excavations and evaluations have not been performed unless otherwise stated.
- 14) **The measures noted within this report are designed to assist in the protection and preservation of the trees mentioned herein, should some or all of those trees remain, and to help in their short and long term health and longevity.** This is not however; a guarantee that any of these trees may not suddenly or eventually decline, fail, or die, for whatever reason. Because a significant portion of a tree's roots are usually far beyond its dripline, even trees that are well protected during construction often decline, fail or die. Because there may be hidden defects within the root system, trunk or branches of trees, it is possible that trees with no obvious defects can be subject to failure without warning. The current state of arboricultural science does not guarantee the accurate detection and prediction of tree defects and the risks associated with trees. There will always be some level of risk associated with trees, particularly large trees. It is impossible to guarantee the safety of any tree. Trees are unpredictable.

Deborah Ellis, MS

Consulting Arborist & Horticulturist



Service since 1984

I certify that the information contained in this report is correct to the best of my knowledge, and that this report was prepared in good faith. Thank you for the opportunity to provide service again. Please call me if you have questions or if I can be of further assistance.

Sincerely,

Deborah Ellis, MS.
Consulting Arborist & Horticulturist
Certified Professional Horticulturist #30022
ASCA Registered Consulting Arborist #305
I.S.A. Board Certified Master Arborist WE-457B



Enclosures:

- Tree Maps #1, 2 and 3 as .PDF files
- Tree Map of the complete complex as KMZ file
- Tree Table (partial) as Microsoft Excel file

PO Box 3714, Saratoga, CA 95070. 408-725-1357. decah@pacbell.net. <http://www.decah.com>.

Arborist Report for Cupertino Civic Center Master Plan. January 2, 2015.



GLOSSARY

1. **Arborist, Qualified Consulting:** must be either an International Society of Arboriculture (ISA) Board-Certified Master Arborist or an American Society of Consulting Arborists (ASCA) Registered Consulting Arborist that has sufficient knowledge and experience to perform the specific work required.
2. **Arborist, Project:** The arborist who is appointed to be in charge of arborist services for the project. For most construction projects that work will include inspection and documentation of tree protection fencing and other tree protection procedures, and being available to assist with tree-related issues that come up during the project.
3. **Basic Evaluation (of trees):** A visual evaluation of the tree from the ground, without climbing into the tree or performing detailed tests such as extensive digging, boring or removing samples. This is an initial screening of the tree after which the evaluator may recommend that additional, more detailed examination(s) be performed.
4. **Canker:** an area of dead bark. A localized lesion on a stem or branch, often sunken in appearance, commonly associated with a wound, decay or death of internal tissues. Cankers often extend beyond the extent of an original infection or wound, killing surrounding previously healthy tissue. If decay is present and spreads into the wood, a very weak area is created because both the inner and outer growth rings are affected. Internal decay can sometimes spread outward killing bark and new wood tissue – this is called a *canker rot*.
5. **Chlorosis/chlorotic:** chlorosis is a plant symptom exhibited abnormally yellow colored foliage. Such foliage is described as *chlorotic*. This symptom can have many causes such as lack nutrients, diseases or high soil salinity.
6. **Co-dominant** refers to two leaders, branches or trunks that arise at the same point on a tree and are about the same diameter. This is an undesirable structural defect that is a weak point in the tree. Co-dominant stems typically lack the overlapping tissue present in a branch or trunk collar, which may be why trees with this defect split so easily. Included bark between members also reduces the strength of the union. It is best that branches or trunks originate with space between them, or if they arise at the same point that they be of different sizes. Co-dominant leaders can often be corrected (one leader removed) when trees are young.
7. **Conk:** the fruiting body (reproductive structure) of a wood decay fungus, from which spores are released. It usually assumes a “shelf-like” orientation when growing from the side of a trunk or branch. On top of roots, conks often assume a flat or “tabletop” shape. Conks are often a sign that extensive decay has already occurred within the wood.
8. **Crooks** are unnatural bends or sharp angles in branches or trunks caused by the removal of other attached branches or trunks, often with a vertical growing side branch at the end. This concentrates weight at the end of the branch, and also over some inevitable decay from a pruning wound.
9. **Deciduous:** a plant that sheds all its leaves at a specific time of the year, usually during the winter when the weather is cold. As opposed to “evergreen” which are plants that retain their leaves in living condition all year long, never dropping all their leaves at once.
10. **Dripline:** the area under the total branch spread of the tree, all around the tree. Although tree roots may extend out 2 to 3 times the radius of the dripline, a great concentration of active roots is often in the soil directly beneath this area. The dripline is often used as an arbitrary “tree protection zone”.



11. **Gall:** An irritation caused by insects, nematodes, disease organisms such as fungi, environmental insults and unknown factors can cause these swellings or tumor-like growths on the leaves, fruit, twigs, trunks or roots of plants. When located on a woody plant such as a tree, galls can reduce the strength of that part. Tissue growth within galls is disorganized, thin-celled and generally weaker.
12. **Ganoderma applanatum** is a fungus that causes a heart rot or decay of live and dead trees. It can also attack and kill a wide variety of trees, from conifers to hardwoods. The fungus colonizes wounds, kills the sapwood of some tree species, and causes decay of both sapwood and heartwood in roots, butts and trunks. The fungus can spread vegetatively through natural root grafting as well. Columns of decaying wood extend as far as 15 feet above and below the fruiting bodies (conks) on trunks. In the roots the fungus is usually restricted to within 3 feet of the soil line. The conks (the shelf-like fruiting bodies that emerge from the tree) are usually found near ground level or on the lower part of the trunk, and often on an old wound. Destruction of the sapwood over time leads to the decline or failure of the tree. Because diseased trees often break or fall before death, the only overt indicator of disease in most standing trees is the conk.
13. **Girdling roots** are roots that grow circularly around the trunk (rather than away from the trunk) and compress the trunk or other roots, constricting the growth of these parts. Circling roots grow similarly, but they do not (or have not yet) restricted growth. Girdling roots can inhibit the flow of water and nutrients by “choking” vascular elements in the trunk or other roots, and they can also cause whole-tree failures at the root collar.
14. **Grove:** is a group of trees that located close together that shelter each other from wind and the elements, having “knit” canopies. If of the same species, there is usually root grafting between trees, which lends support from the ground, as well as water and mineral sharing. Removal of one or some grove members could cause remaining members to be unstable due to a reduction of previous shelter. Grove trees often have asymmetrical canopies when viewed as individuals.
15. **Included bark** is bark sandwiched between adjacent branches, a branch and the trunk, or two or more trunks, often appearing as a seam. In contrast, a normal attachment will have a ridge of bark protruding upwards and a continuous wood connection between adjacent members. An included bark branch or trunk attachment is weaker than a normal attachment. As branches or trunks with included bark grow, they expand in diameter, squeezing the bark along the seam. This may kill some portion of the included bark. When this occurs, a wound response is initiated. As a consequence, cracks can be generated, leading to breakage. Such defects can often be completely removed when a tree is young (e.g. the offending members equal or less than 2 inches in diameter). Older, larger cuts (such as 6 inches in diameter or more) could cause decay to spread into the remaining member, which is undesirable. In these cases it may be best to thin one member (usually the smaller member) by 25% to slow its growth and ultimate size.
16. **Leader:** the primary terminal shoot or trunk of a tree.
17. **Mistletoe** is a parasitic plant that reproduces by seeds covered with a sticky material and usually spread by birds. There are several species of mistletoe that attack different species of host plants, mainly trees. An otherwise healthy tree can tolerate a few mistletoes, but individual branches on the tree may be killed. Plants infected with mistletoe can suffer from reduced vigor or become stunted.
18. **Multiple trunks (leaders) or branch attachments** are a common structural defect in many tree species such as ash and flowering pear. In this condition, more than one branch or trunk originates at the same point. These attachments are not as strong as well-spaced branches or trunks, particularly if included bark between them that prevents a solid wood connection.
19. **Root collar:** The junction between trunk and roots at the base of the trunk, normally just above the soil surface. This area is critical to whole-tree health and stability. Buttress roots important in whole-tree stability emerge from the root collar.



20. **Root rot disease** is caused by wet, poorly aerated soil conditions. Degradation of roots (root rot) and sometimes the lower trunk (crown rot) ensues on weakened, susceptible plant species not adapted to such a soil environment. Opportunistic plant root pathogens (such as water mold fungi) are often the secondary cause of the problem. Root rot is a particular problem among drought tolerant plants that are not adapted to frequent irrigation during our normally rain-free months, such as many of our California native plants. The problem is often worsened in fine-textured heavy clay soils that retain water more than do the coarser, fast-draining soils such as occur in the natural environment of many of our native plants.
21. **Scaffold branch:** a primary structural branch arising from the trunk of a tree. Usually the largest and often the lowest branches of the tree.
22. **Stump sprout trees** are the result of a tree trunk being cut down to a short stump close to the ground. If the tree survives, it sends out many small shoots (suckers) from around the cut stump. Some of these suckers may survive and grow to become significant trunks. These trunks are spaced very close together and usually have included bark between them, which reduces the strength of their union. Such trunks are prone to failure. Stump sprout trees can be very structurally unsound, particularly as they become large and old. There is often a great deal of decay associated with the mother stump, which can also reduce mechanical stability.
23. **Sub trunks:** smaller trunks originating from a larger trunk below.
24. **Suckers** are secondary upright shoots arising from the roots or root collar (junction between roots and trunk) of a tree, or below the graft union. On a grafted tree the suckers (originating from the stock which includes the roots), are often not the same plant species as the scion (the grafted, desirable aboveground part). Suckers can be a nuisance in landscape situations. In nature however, suckers can serve to keep a tree alive after fire or mechanical damage that kills or removes the aboveground part of the tree.
25. **Sunscald** is the death of bark, and sometimes the underlying wood, due to the heat of the sun. This often occurs when over-pruning removes a large amount of foliage, newly exposing previously sheltered tissue.
26. **Topping** is the practice of indiscriminately cutting back large diameter branches of a mature tree to some predetermined lower height; to reduce the overall height of the tree. Cuts are made to buds, stubs or lateral branches not large enough to assume the terminal role. Reputable arborists no longer recommend topping because it is a particularly destructive pruning practice. It is stressful to mature trees and may result in reduced vigor, decline and even death of trees. In addition, branches that regrow from topping cuts are weakly attached to the tree and are in danger of splitting out. Large topping cuts may have significant decay associated with them, which weakens the branch as well as the attachment of any secondary branches attached nearby. Topping may be useful however, for immediately reducing the risk of a high risk tree that will soon be removed.
27. **Tree Service, Qualified:** A tree service with a supervising arborist who has the minimum certification level of ISA (International Society of Arboriculture) Certified Arborist, in a supervisory position on the job site during execution of the tree work. The tree service shall adhere to the most current of the following arboricultural industry tree care standards:
- ANSI A300 *Pruning Standards*. (Covers tree care methodology).
 - ANSI Z133.1 *Safety Requirements for Arboricultural Operations*. (Covers safety).
 - *Best Management Practices, Tree Pruning*. International Society of Arboriculture.

This page intentionally left blank.

APPENDIX A - 09

Cupertino City Hall Essential Services Facility Analysis
(AKH, 2012)

Cupertino City Hall Essential Services Facility Analysis

Final Report, Revision 1
March 27, 2012

Table of Contents

1.0 Project Participants

2.0 Executive Summary

3.0 Structural Analysis

- 3.1. Scope
- 3.2. Applicable Codes
- 3.3. Deficiencies Identified
- 3.4. General Recommendations
- 3.5. Specific Recommendations
- 3.6. Recommendations

Figure 3A Key Structural Building Plan
Figure 3B Key Roof Plan
Figure 3C-G Connections Details

4.0 Architectural Analysis

- 4.1. Scope
- 4.2. Applicable Codes
- 4.3. Fire and Life Safety Key Issues
- 4.4. Other Issues
- 4.5. Recommendations

Exhibit 4A: Code Analysis Work Sheet
Exhibit 4B: Accessibility for Existing Building
Exhibit 4C: Occupancy Load and Exit Diagram First Floor
Exhibit 4D: Occupancy Load and Exit Diagram Basement Floor

5.0 Mechanical, Electrical, Plumbing, Fire Protection Analysis

- 5.1. Scope
- 5.2. Applicable Codes and Standards
- 5.3. Mechanical
- 5.4. Plumbing
- 5.5. Fire Protection
- 5.6. Electrical

Appendix:

Kick-off Meeting Minutes (2/14/2012)
Clarification of Alternatives (2/21/2012 E-mail message)

1.0 Project Participants

Client:

City of Cupertino
10300 Torre Avenue
Cupertino CA 95014

Carmen Lynaugh	Public Works Project Manager
Terry Greene	Acting City Architect
Larry Squarcia	Senior Building Inspector
Albert Salvador	Building Official
Arnold Hom	Plan Check Engineer
Timm Borden	Director of Public Works
Chris Orr	Facilities Supervisor
Rick Kitson	Public and Environmental Affairs Director

Architect:

Perkins + Will
185 Berry Street, Suite 5100
San Francisco, CA 94107
Phone: 415.856.3000

Karen Alschuler	Project Principal
Susan Seastone	Project Manager
Haji Ishikawa	Project Architect

Structural Engineer:

AKH Structural Engineers Inc.
1505 Meridian Avenue, Suite B
San Jose, CA 95125
Phone: 408.978.1970

Tim Hyde	President
----------	-----------

Mechanical, Electrical, Plumbing, Fire Protection Engineers:

PAE Consulting Engineers, Inc.
425 California St., Ste. 1200
San Francisco, CA 94104
Phone: 415.544.7500

Mike Lucas	Project Principal
Marco Alves	Mechanical Project Engineer
Hooshang Pakzadan	Electrical Project Engineer

2.0 Executive Summary

This scope of this project is an analysis of the Cupertino City Hall building and its compliance with current codes related to Essential Services Facility requirements. The objective of this study is to identify both deficiencies and potential improvements to the building necessary to achieve essential facility status by current codes.

Four alternative approaches were identified by the City of Cupertino representatives and the design team for the renovation of the existing City Hall facility. These approaches, described below, differ in their scope and anticipated construction cost. More detail for each item can be found in the body of the report.

Alt #1 No Upgrade: This alternate proposes no modifications to the existing City Hall building and a relocation of the existing Emergency Operations Center (EOC) to another facility.

Alt #2 Minimum Seismic Upgrade: This alternate proposes modifications to the building structure only to bring the facility to a code compliant Essential Services Facility status. No proposed plan changes are proposed in this alternate in order to maintain the ability to “grandfather in” the existing EOC in its current configuration. Only structural items triggered by I-factor improvements and maintenance are intended to be modified. Accessibility upgrade improvements may be triggered in this alternate.

Alt #3 Moderate Upgrade: This alternate proposes that all Alternate #2 items as well as additional plan modifications to address life safety code updates be implemented. Accessibility upgrade improvements would be triggered in this alternate.

Alt #4 Replacement – This alternate proposes a new City Hall building that aligns with ideas being proposed in the Civic Center Master Plan Study currently in process by Perkins + Will. This new facility would meet all current codes, incorporate sustainable features, and include Essential Services Facility requirements while at the same time address the specific needs and desires of the building occupants.

Following the completion of this report, the City of Cupertino and the design team will meet with a cost estimator designated by the city to identify order of magnitude costs for each alternative. After this process has been completed and an alternative is selected, the city may authorize the design team to proceed with the design and documentation of the selected alternative.

3.0 Structural Analysis (by AKH)

3.1 Scope

The scope of this section includes recommendations for mitigating structural deficiencies discovered in our assessment report dated November 11, 2011. The report has indicated that the heavy roof tile is a major factor in the deficiencies of the structure. The following recommendations are based on the assumption that the heavy tile roofing will be replaced by a lighter roofing material, and possibly with solar panels over some of the sloped roof areas.

3.2 Applicable Codes

The structure was recently assessed using seismic forces required in the 1985 Uniform Building Code (UBC), as this was the Code to which the 1986 alterations were designed. Recommendations within this report are based on seismic forces as dictated by the current 2010 California Building Code (CBC).

3.3 Deficiencies Identified

- Roof Diaphragm Shear Capacity
- Roof Diaphragm Collector Splice Capacity
- Anchor Bolt Connections at top of Shear Walls
- Upper Concrete Shear Wall Flexural Capacity
- Upper Concrete Shear Wall Boundary Members
- Upper Concrete Shear Wall Second Layer of Reinforcing
- Concrete Column Reinforcement for Confinement
- Equipment Anchorage Capacities Unknown

3.4 General Recommendations

This structure consists of concrete shear walls with heavy clay roof tiles on the sloped roof areas and heavy gravel ballast in the central area bounded by the upper mansard/screen wall. The roof tiles represent a significant portion of the building's mass at the upper level. The design seismic forces on a structure are based directly on a fraction or percentage of the total mass (weight) of the building. Thus, the roof tiles represent a significant amount of the seismic forces that the building's lateral force-resisting systems must resist. Our recommendations, therefore, include the replacement of the heavy tile roofing with a lighter material. This would also allow for the opportunity to install photovoltaic (PV) solar panels on the roof surface. As the weight of typical PV panels is small relative to the weight of the existing clay roof tiles, future improvements could include the addition of these PV panels while still reducing the building's mass and resulting seismic design forces.

Also, the upper story of this structure relies on two relatively narrow concrete shear walls on each of the four sides of the building. These shear walls comprise the building's entire lateral force resistance at the upper level, as the structure does not have any interior walls or structural frames that resist lateral forces. While the shear walls occur on each of the building's four sides, the walls are relatively narrow compared to their height, resulting in high in-plane shear stresses when resisting the seismic design forces, as well as relatively high tension and compression forces at the ends of the walls. Finally, the use of only two primary force-resisting elements on each side of the structure provides

only minimal redundancy. Overall, the smaller number and length of walls result in a structural configuration that has historically performed less than optimally in resisting lateral, seismic forces in moderate and major earthquakes. Therefore we recommend that additional shear walls be added on each side of the structure. The included key plan of the building indicates where concrete walls can be added to the building, utilizing portions of existing solid exterior wall. These proposed locations would affect the building's current aesthetics and function to only a limited degree, if at all. See Fig. 3.A.

In general, if the clay roof tiles are replaced with lighter roofing materials (even including PV panels), the building's seismic mass would be reduced substantially, and the magnitude of most of the structure's noted deficiencies are reduced to levels that are more readily addressed.

3.5 Specific Recommendations

In addition to the general recommendations above, following are our specific recommendations for each of the deficiencies noted in the Section 3.3 above:

3.5.1 Roof Diaphragm Shear Capacity

The existing roof diaphragm is comprised of plywood sheathing with specific nailing along its panel edges to common framing members. Its shear capacity is affected by the type and thickness of plywood used, and the size and spacing of nailing used. The existing roof diaphragm shear capacity is exceeded even if the existing roof tile were to be removed and replaced with a lighter roofing material. The roof diaphragm forces would be reduced significantly with the replacement of the heavy clay roof tiles, although the calculated diaphragm shears would still exceed the diaphragm near the building's perimeter, which is where the diaphragm shear forces are highest. The plywood diaphragm can be strengthened as needed with added panel edge nailing near the perimeter of the building. This added nailing would be installed while the roofing is being replaced. See Figures 3.B and 3.G.

3.5.2 Roof Diaphragm Collector Splice Capacity

The existing roof diaphragm collectors consist of steel roof beams around the perimeter of the structure, and are aligned parallel to and above the upper-level concrete shear walls. These elements collect the seismic forces within the roof diaphragm and deliver the forces to the shear walls. Where splices occur in the lines of steel beams at approximately ten (10) locations, the connectors are currently not adequate to transfer the required seismic collector forces. Our recommendation to address this deficiency would be to provide welding around the splice plates to the beams at the splice connections. See Fig. 3.F.

3.5.3 Anchor Bolt Connections at top of Shear Walls

The collector beams mentioned in the previous section are connected to the top of the concrete shear walls with anchor bolts embedded in the walls and extending through the steel beam flange. This is the means through which the seismic forces are transferred from the roof to the shear walls. The current anchor bolts are insufficient to transfer the prescribed forces to the shear walls, even with added shear walls. Our recommendation is to provide adequate anchor bolts to any new walls and provide additional anchor bolts through the existing beams, between the existing anchor bolts, to strengthen the shear-transfer connections sufficiently. See Fig. 3.F.

3.5.4 Concrete Shear Wall In-Plane Flexural Capacity

In-plane flexure results from the shear walls bending when resisting seismic loads at their tops, tending to rotate and bend the wall over, causing tension and compression at wall ends. With the addition of upper-level new shear walls as recommended above, this flexural deficiency likely would no longer exist in the existing walls, as the forces resisted by the existing walls would be reduced, as well as the induced flexural forces. The added shear walls would be designed to have sufficient reinforcing to resist bending in the plane of the wall.

3.5.5 Concrete Shear Wall Boundary Members

Boundary members are required where the in-plane flexural forces generate high compressive forces at the wall ends. These compressive forces, when at a certain level, must be resisted by stronger column-type elements, containing internal confinement of the vertical wall reinforcing near the wall ends. The existing walls would require added boundary confinement to resist current Code-level forces. With the removal of the heavy roof tile and gravel, and depending on the lengths and locations of added shear walls as noted above, the compressive flexural forces would be reduced to a level where only the current Code's prescriptive requirements would be applicable. This could be accomplished in one of two possible means. First, a short length of reinforced wall could be added to the existing, which would move the highest compressive forces away from the existing bars, and would contain new bars and confinement complying with Code requirements. Second, if the wall length cannot be increased, a column element that is wider than the wall could be introduced, containing the required confining reinforcement.

3.5.6 Concrete Shear Wall Second Layer of Reinforcing

When calculated in-plane shear stresses within shear walls exceed a certain threshold, those walls must have two layers of internal reinforcing. The shear walls currently have one layer of reinforcing, comprised of vertical and horizontal rebar. With the removal of the heavy roof tile and addition of new perimeter shear walls as noted above, the shear stresses

within the walls will likely be reduced to levels such that the second layer is not required.

3.5.7 Concrete Column Reinforcement for Confinement

The existing concrete columns throughout the structure, at both levels, contain longitudinal reinforcement running vertically and transverse, confining tie reinforcement around the longitudinal bars. The ties are of a specific size and occur at a specific spacing. In extreme cases, such as in moderate and major earthquakes, the lateral drift of the structure, combined with the axial forces from the supported structure, can induce extremely high compressive forces in the longitudinal (vertical) column bars. If not confined adequately by ties of sufficient size, at spacing that is close enough, the vertical bars can buckle outward, causing damage to the column, loss of support and possible collapse. Regardless of the calculated forces in the existing columns, the existing column ties do not conform to the current Building Code's prescriptive requirements for minimum confinement. Thus, supplemental confinement needs to be added for conformance to the current Code. This added confinement may be required only near the ends of some columns, or for the full height of the columns, depending on the calculated column loads. Where additional confinement is required, it is recommended that the columns be wrapped with designed layers of carbon fiber and resin. The total build-up of carbon fiber layers is relatively thin, and would not adversely affect the spaces where the columns occur.

As indicated in these descriptions, and in general, the noted deficiencies can be addressed and resolved only with a sufficient reduction of the building's mass through the removal of the heavy clay tile roofing, and with the addition of some lengths of new upper-level concrete shear walls. The recommended alterations combine to reduce the seismic forces acting on the structure, increase the strength and capacities of the load-resisting elements, including the shear walls and collector members. The following key building plan indicates the recommended locations for the proposed added shear walls, which would likely affect the building's aesthetics and functionality to only a minimal degree.

3.5.8 Equipment Anchorage Capacities Unknown

The capacity of the anchorage of the equipment throughout the building is unknown and warrants a survey of existing on-site conditions, as well as any drawings available that address the methods of anchorage and lateral bracing. The current Building Code excludes some equipment below certain weight limits from requiring anchorage, if the Component Importance Factor (I_p) for determining the anchorage design forces is no higher than 1.0. However, since the entire subject structure is considered an Essential Facility, housing the EOC, the Importance Factor for the overall building's seismic design, as well as the seismic Component Importance factor, I_p , is 1.50. Thus, the seismic anchorage of all

significant equipment anchorage is governed by the Code. Equipment that should be considered, in particular, includes the following:

- Emergency Generator, including isolators
- Emergency Generator flexible connections for conduit, fuel and coolant piping
- Rooftop HVAC Equipment
- Elevator Equipment
- Electrical Transformers, Panels, Switchgear, Cabinets, etc.
- Suspended Light Fixtures
- Ductwork and Piping Supports and Bracing
- Electrical Conduits, Trapezes, Banks and Trays
- Fire Sprinkler Piping

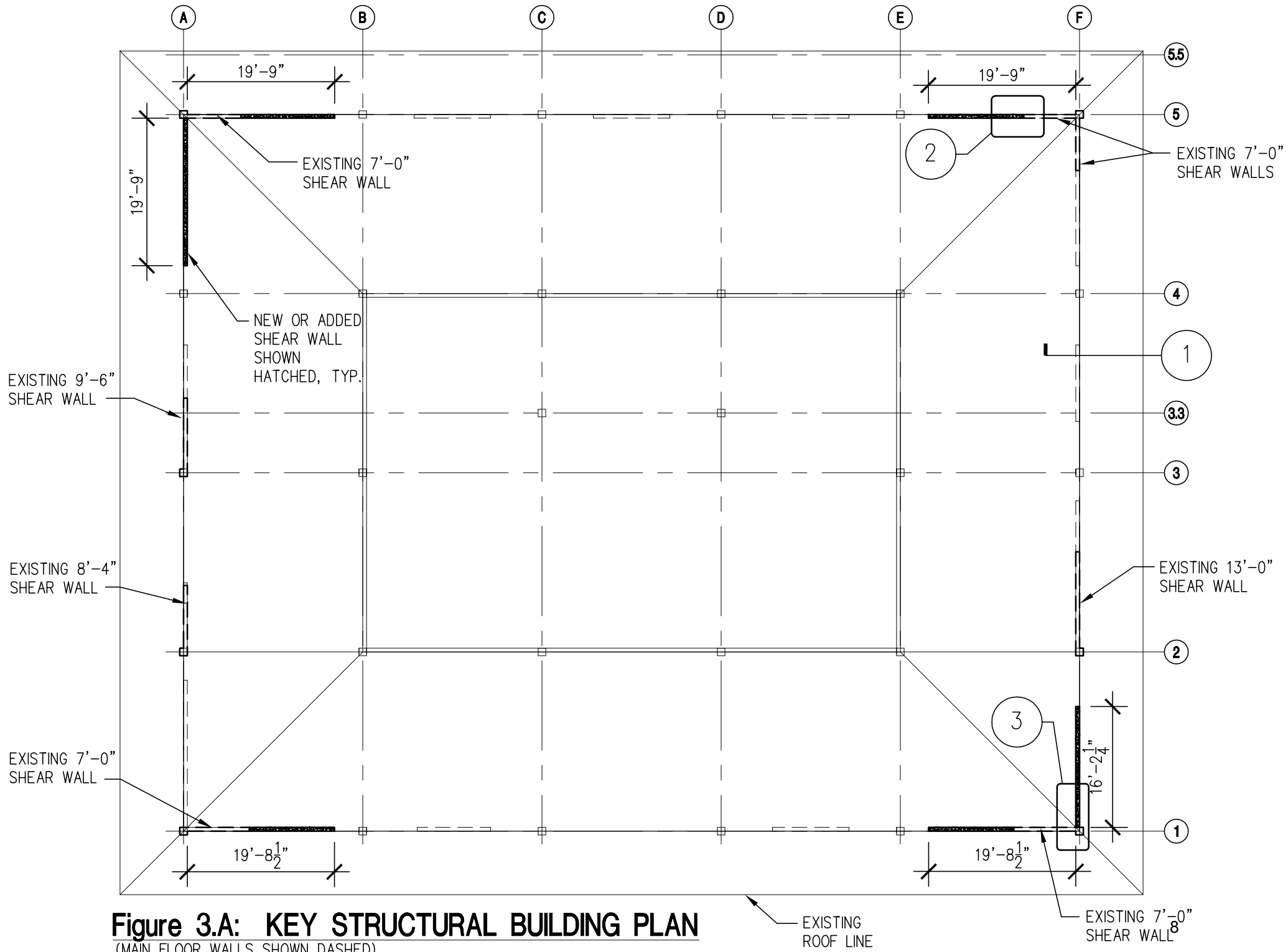

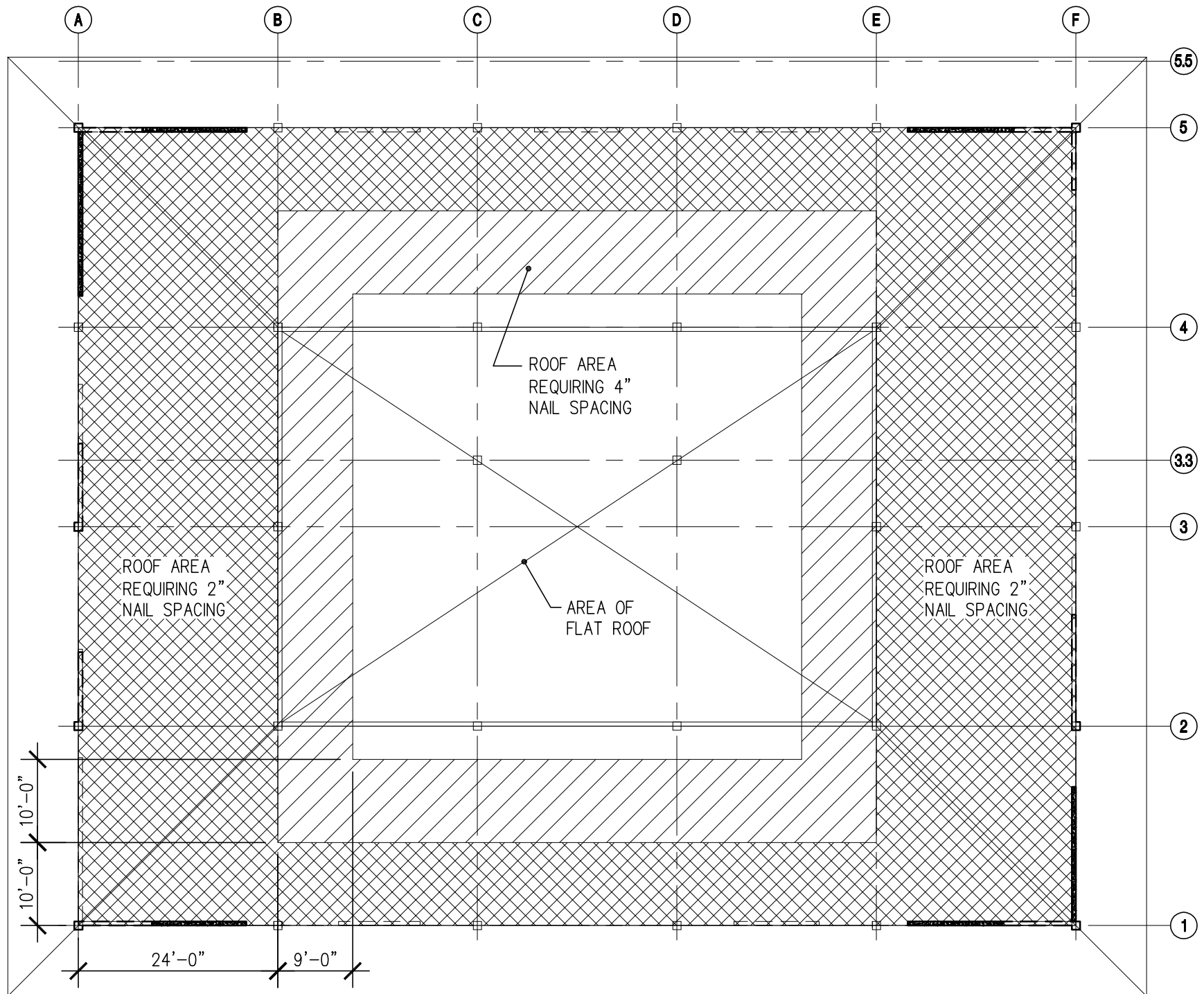

Figure 3.B: KEY ROOF PLAN
 (MAIN FLOOR WALLS SHOWN DASHED)

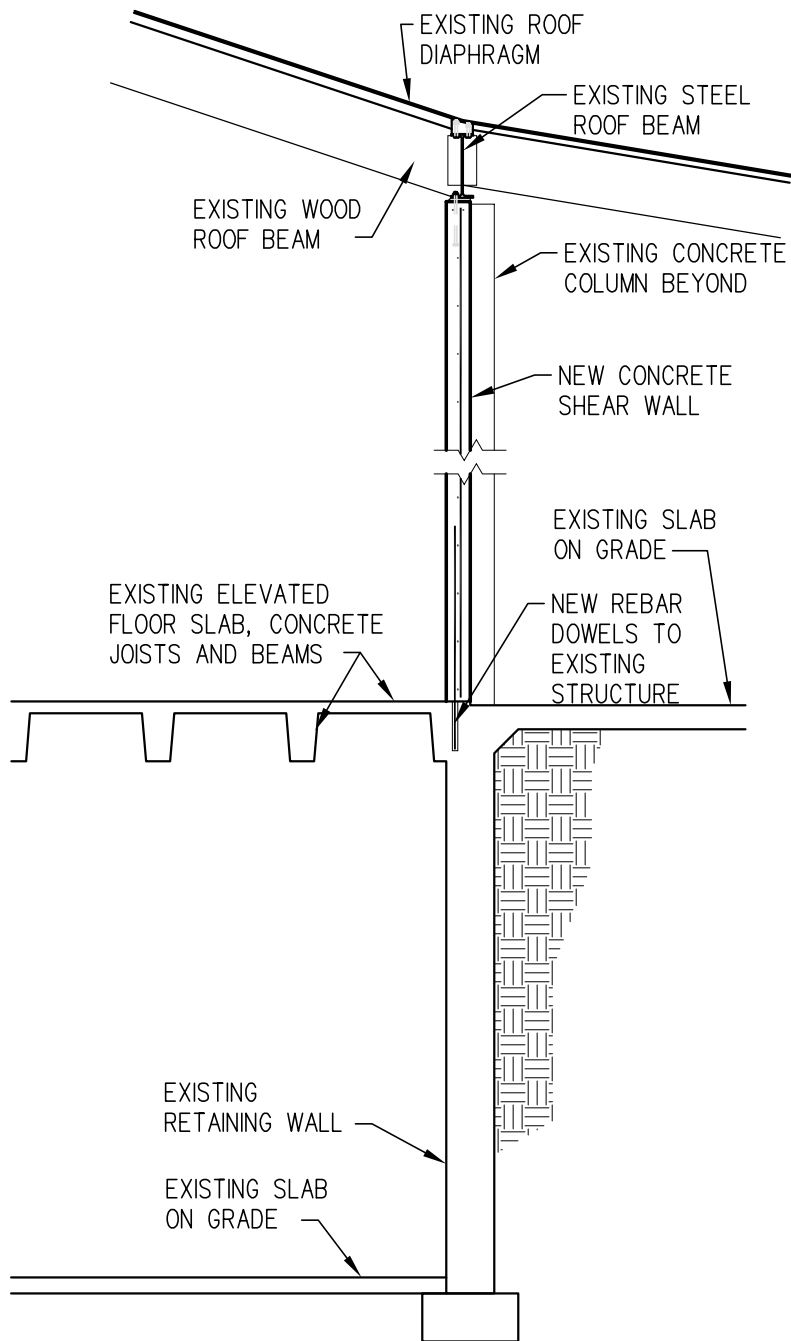

Figure 3.C: SECTION AT NEW SHEAR WALL

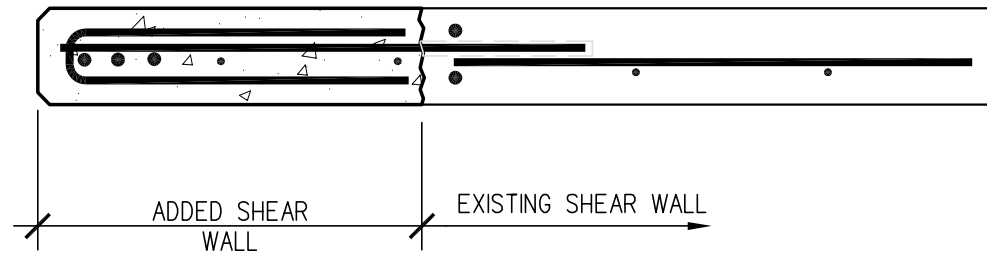

Figure 3.D: NEW SHEAR WALL AT EXIST. WALL

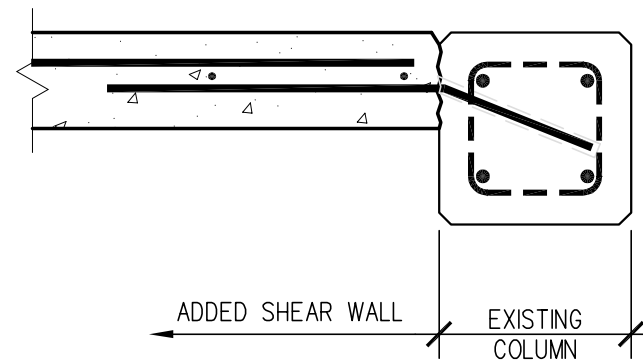

Figure 3.E: NEW SHEAR WALL AT EXIST. COL.

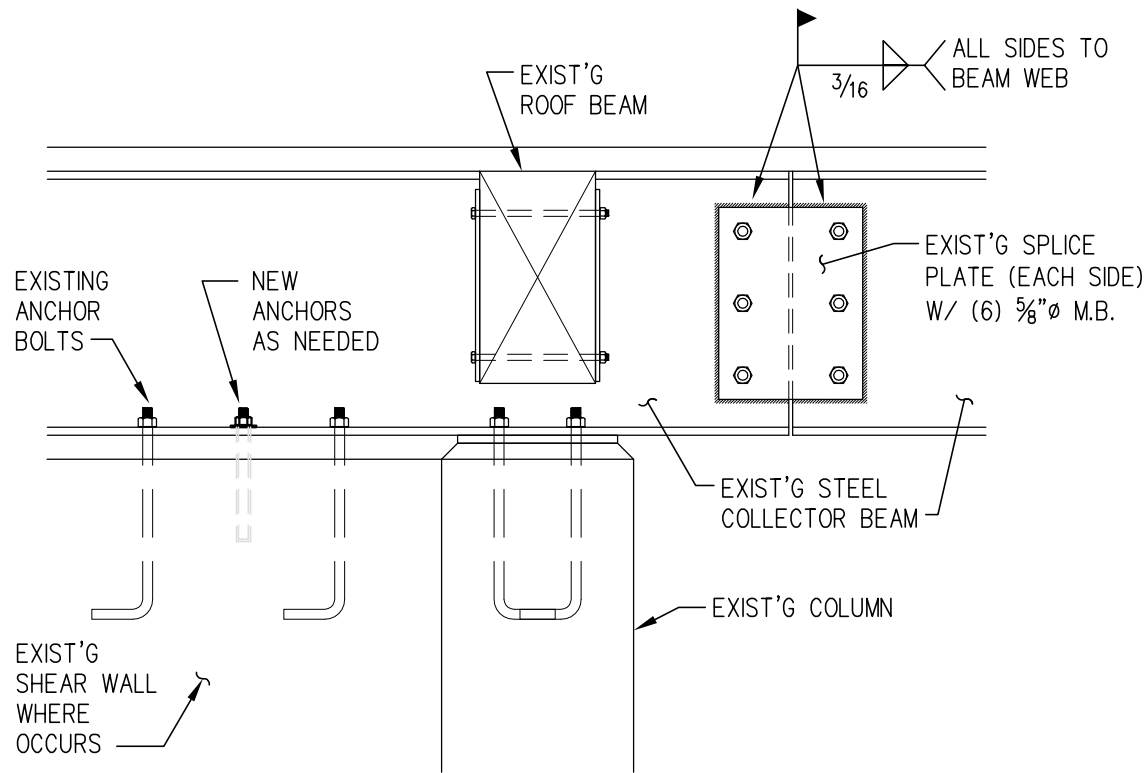

Figure 3.F: ELEVATION: EXISTING STEEL BEAM AT COLUMN AND SHEAR WALL

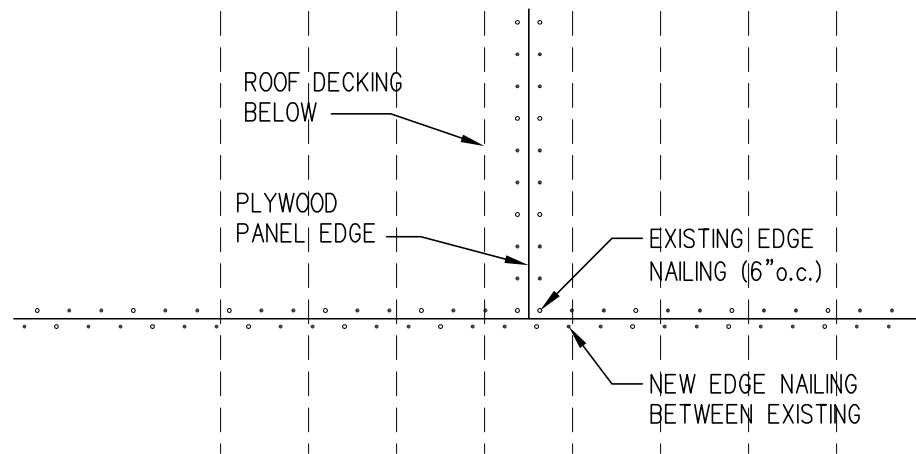

Figure 3.G: PLAN OF PLYWOOD PANEL EDGE NAILING

4.0 Architectural Analysis

4.1 Scope

The existing Cupertino City Hall building is a two-story structure containing city administrative and building department services as well as the City of Cupertino's Emergency Operations Center (EOC.) The original building was built completed in 1965 and later renovated in 1986.

This study is based on record documents listed below and received electronically from the city as well as a facility site walk on Feb 14, 2012.

- 1965 Drawings for Original Construction
- 1986 Drawings for Renovation (except single line Electrical plans)
- Current Exiting Diagram included the latest floor layout modifications

The architectural analysis primarily focuses on fire and life safety issues and includes a detailed code compliancy review of the existing City Hall building as an Essential Service Facility. The recommendations follow the analysis and include four alternatives outlined by city representatives and the design team.

The current code, the 2010 California Building Code (CBC), and the 1985 Uniform Building Code used for the renovation exhibit significant differences in all chapters. The first step of this analysis was to review the existing building against the 2010 CBC. Exhibit 4A provides the analysis in detail. Exhibits 4C and 4D show occupancy load calculations, exit occupancy calculations, and required rated wall locations.

The required scope of accessibility modifications for the existing building is also summarized to define the extent of potential renovation work. Exhibit 4B lists scope requirements from the 2010 CBC Chapter 11B.

4.2 Applicable Codes

The 2010 CBC was used to review code compliancy. The 2010 California Green Building Code (Cal Green) was not used for the analysis of the existing building. Currently, the City of Cupertino does not enforce the Cal Green for the remodel of existing buildings. The requirements of 2010 ADA Standards for Accessible Design is applicable for local government facilities and was also used to review for compliancy.

4.3 Key Fire and Life Safety Issues

The key issues below are extracted from Exhibit 4A - Code Analysis Worksheet.

- **Occupancy Classification**
The existing Council Room is approximately 1,300 sf (over 10% of the total floor area of the first floor) with an Occupancy Load of 86. The room cannot be considered an incidental accessory occupancy because it is too large. It needs to be considered an A3 Occupancy, a separate occupancy from rest of the building, which is a B Occupancy.

- **Type of Construction**
The type of construction is Type VB with an automatic sprinkler system throughout.

- **Fire Resistive Separations**
 - Interior Walls:**
A 1-hour Fire Barrier separation is required between A and B occupancies. The existing wall is shown as a 1-hour partition in the 1986 drawings. The wall construction above the ceiling needs to be further investigated. The doors in the 1-hour Fire Barrier need to have a 45-minute fire resistance rating. The existing two doors are labeled with 20-minute ratings. The label of the third door was covered by finish material and not legible. It will need to be replaced if it cannot be confirmed as compliant. See section 4.5.1 of the 2010 CBC.

Although the 1-hour separation requirement of an incidental use area is exempted because the existing building is equipped with a sprinkler system, the Mechanical Room and Storage Rooms (over 100 sf) require smoke partitions. The 1986 drawings indicate the existing Mechanical Room is enclosed by a 1-hour partition. See section 4.5.2 of the 2010 CBC.

 - Elevator Shaft Enclosure:**
The existing elevator shaft may be deficient. The drawing A2.1 (1986 Renovation) indicates “Carry shaft wall to underside of lobby ceiling”. Fire Barriers need to extend to the underside of the roof sheathing per 707.5 or enclosed at the top with the same fire resistance rating per 708.12. See section 4.5.3 of the 2010 CBC.

 - Exit Stair Enclosure:**
The exit stair enclosure wall needs to be a 1-hour Fire Barrier with a 1-hour rated opening. The existing door on the first floor is labeled as 60-minute. The rating of the door on the basement was not legible and will need to be replaced if it cannot be confirmed as compliant. See section 4.5.4 of the 2010CBC.

- **Corridors**
The building’s corridors are not required to be separated by fire or smoke partitions because the existing building is A and B Occupancies and equipped with a sprinkler system. The existing corridors open to the public area are rated per the 1986 drawings. The existing openings between the west corridor and the office area are allowed per the current code.

- **Interior Finishes**

- **Wall and Ceiling:**

- Corridors serving the egress of the EOC, West Corridor, Lobby, and South Corridor require Class B finishes on the walls and ceiling. The existing finish materials need to be further examined to confirm that they meet the ASTM E-84 Class B frame spread rating and the ASTM C 635 or C636 for suspended acoustical ceiling. See section 4.5.6 of the 2010 CBC.

- **Floor:**

- A Class I or II interior floor finish is required in all exit routes. The existing finishes need to be further reviewed and replaced if they cannot be confirmed as compliant. See section 4.5.6 of the 2010 CBC.

- **Means of Egress**

- **Occupant Load:**

- The Occupant Load of the existing building is calculated based upon the area under consideration divided by an occupant load factor per section 1004.1.1 of the 2010 CBC. See Exhibit 4A.

- **Egress Width:**

- All existing doors and corridors currently provide more than the required egress width. Exiting occupancies at the exit discharge are:

Basement Terrace	98
Main entrance	57 (113 / 2 exits)
South Corridor Door	35
North Door	29

- **Accessible Means of Egress:**

- Accessible means of egress are not required in alterations to existing buildings per section 1007.1 Exception 1 of the 2010 CBC.

- **Panic Hardware:**

- Mechanical Room and Transformer Room doors need panic hardware or fire exit hardware per section 1008.1.10 of the 2010 CBC. The existing doors do not have the required hardware.

- **Vertical Exit Enclosures–Lobby Open Stairs to Basement:**

- The analysis of the exiting occupancy revealed that the basement floor egress is not code compliant without using the open stairs as means of egress. The 2010 CBC allows for vertical openings in a stairway only if it is not part of means of egress per 708.2 Exceptions; therefore, in order to meet the requirements of the code the stair will require the installation of draft curtains and closely spaced sprinklers. These upgrades based on the interpretation above are believed to be more economical than

converting the open stairway to an enclosed exit stair. See section 3.5.7 of the 2010 CBC.

- **Roof Assembly and Rooftop Structure**

A roof assembly is required to meet Class A fire test exposure in accordance with the city ordinances. The existing roof equipment shows an incomplete attachment mechanism to the roof deck. See section 3.5.8 of the 2010 CBC.

4.4 Other Issues

4.4.1 Accessibility

The extent of the specific accessibility upgrades will require further study as well as design solutions after a solution is selected. Exhibit 4B describes accessibility requirements for existing buildings.

The 2010 CBC requires that accessibility upgrades apply only to the area of specific alteration. The 2010 ADA Standards (Chapter 2, 202) state “each altered element or space shall comply with the applicable requirements”.

The 2010 CBC also outlines construction cost thresholds for specific levels of accessibility upgrades. For a project where the construction cost does not exceed \$50,000, it requires accessibility compliance only in the area of the actual work and not in supporting areas. For a project where the construction cost does not exceed \$128,410.86, it allows accessibility compliance to be limited to 20% of the cost of the project. Priority must be given to the accessible elements in the following order.

- sanitary facilities
- drinking fountains
- signs
- public telephone
- additional accessible elements such as parking, storage, and alarms

For a project where the construction cost exceeds \$128,410.86, the facility must be made fully accessible.

4.4.2 OSHA

Access to all areas for building maintenance will need to meet Cal-OSHA standards. The metal ladder to the roof requires a safety upgrade.

4.4.3 Sustainability

A comprehensive sustainable strategy and specific sustainable solutions are not identified in this report; however, as the project moves to the next phase we would recommend incorporating a sustainable approach into the solution selected.

4.4.4 Architectural & Planning

Several architectural and planning issues were identified by the building representatives and design team during the Feb 14, 2012 site walk. These items

were captured in the Meeting Minutes, item 2012-02-14.07, and should be addressed if Alternate #3 or Alternate#4 is selected for implementation.

4.5 Recommendations

Four alternative approaches were identified by the City of Cupertino representatives and the design team for the renovation of the existing City Hall facility. These approaches, described below, differ in their scope and anticipated construction cost.

Alt #1 No Upgrade: This alternate proposes no modifications to the existing City Hall building and a relocation of the existing EOC to another facility.

Alt #2 Minimum Seismic Upgrade: This alternate proposes modifications to the building structure only to bring the facility to a code compliant Essential Service Facility status. No proposed plan changes are proposed in this alternate in order to maintain the ability to “grandfather in” the existing EOC in its current configuration. Only structural items triggered by I-factor improvements and maintenance are intended to be modified. Accessibility upgrade improvements may be triggered in this alternate. The modifications include:

- Replacement of roof tile – as maintenance
- Possible adjustment of roof profile and equipment screen
- Connection of collector beam and concrete shear wall
- Additional concrete wall to the main level, if required. (The modification should not affect floor plan and egress)
- Ducts and equipment seismic support
- Accessibility upgrade for 20% of construction cost if required

Alt #3 Moderate Upgrade: This alternate proposes that all Alternate #2 items as well as additional plan modifications to address life safety code updates be implemented. Accessibility upgrade improvements would be triggered in this alternate. The modifications include:

- All Alt #2 items
- Fire and Life Safety upgrade to meet 2010 CBC
- MEP upgrades to meet operation requirements as Essential Services Facilities including replacement of HVAC equipment/control, water heater/plumbing pipe, adjustments of sprinkler system, and upgrade of the electrical system after testing and verifications.
- Minimum energy efficiency to meet performance of the existing building
- Accessibility upgrade

Alt #4 Replacement – This alternate proposes a new City Hall building that aligns with ideas being proposed in the Civic Center Master Plan Study currently in process with Perkins + Will. This new facility would meet all current codes, incorporate sustainable features, and include Essential Service Facility requirements while at the same time address the specific needs and desires of the building occupants.

These recommendations are based on the findings from the available drawings and observations of the accessible areas during the site walk. As highlighted above, some areas of the existing building have unknown conditions and will require further investigation after an alternate is selected:

- penetrations thru partitions
- above-ceiling conditions
- actual construction of the interior partitions
- storage rooms created during the recent renovation around the EOC
- renovated areas in locations where the record drawings were not available

Specific recommendations for the correction of items identified in the code analysis are outlined below. If Alternative #3 or Alternative #4 described above is chosen, all architectural code deficiencies must be integrated into the solution.

4.5.1 1-hour Fire Barrier at Council Room

The existing doors to the Council room need to be replaced with at least 45-minute fire resistance rated doors. The partition may need to be repaired or rebuilt to meet 1-hour Fire Barrier requirements. The existing rated partition enclosing Council room should be further field investigated.

4.5.2 Smoke Partitions to Mechanical Room and Storage Room

The existing doors to the Mechanical Room and Transformer Room need to be replaced with panic hardware. The existing wall and doors enclosing the Mechanical Room need to be rebuilt or repaired to meet smoke partition requirements.

Mechanical Room work space clearances and clear path of travel require further investigation near the 1600 Amp electrical panel. The room requires either 2 exits with panic hardware or 1 exit door with panic hardware and a clear unobstructed path from panel to exit door, or a single exit door with panic hardware and double the required working space around the panel.

Storage Rooms (areas exceeding 100sf) need to be enclosed by smoke partitions. The Storage Rooms north of Council Room that were recent additions/modifications exceed 100sf. These walls and doors need to be rebuilt or repaired to meet smoke partition requirements.

4.5.3 Elevator Shaft Enclosure

The construction of the existing elevator shaft enclosure needs further field investigation to verify if it meets the 1-hour Fire Barrier requirements. The shaft enclosure may either need to extend to the roof sheathing or be enclosed at the top of the shaft with 1-hour fire resistance rated assembly.

4.5.4 60-Minute Door to the Exit Stair at Basement

The exit access door to the existing exit stair should be confirmed as a 60 minute door or replaced with a 60 minute door. The construction of the existing exit stair shaft enclosure needs further field investigation to verify if it meets the 1 hour Fire Barrier requirements.

4.5.5 Interior Finishes

The finishes of West Corridor, Lobby, and South Corridor need further field investigation to confirm if they meet the current code classifications. The finishes may need to be replaced to meet the requirements.

4.5.6 Lobby Open Stairs to Basement

The existing open stairs from Lobby to the basement should be designated as non-exit stairs. In addition, the draft curtains and closely-spaced sprinklers per NFPA 13 need to be installed. The exit sign should be rearranged accordingly.

4.5.7 Roof Assembly and Rooftop Equipment

The attachment of the roof equipment to the roof deck must be secured following the I factor requirements for the Essential Services Facilities. Reroofing assembly is required to meet Class C roofing.

4.5.8 Replacement of Roof Tile (This item is for Alt #2)

As described in the Structural Section 3.4 General Recommendations, the heavy tile roofing should be replaced with a lighter material such as standing seam metal roofing system. A system can be selected to match the appearance of the adjoining buildings in the Civic Center. As the project proceeds an option to integrate photovoltaic panels or film at the roof should be investigated.

	Subject	CBC Reference	Notes								
	o not required not mre than 3 stories in Group B	708.14.1	OK								
	o not required for A where the building is fully-sprinklered	708.14.1 Ex 4	OK								
12.	Penetrations										
	<ul style="list-style-type: none"> Thru penetration fire stop systems protecting wall penetrations shall have an F rating equal to the rated wall 	713.3.1.2	Visually inaccessible, Need further investigation								
	<ul style="list-style-type: none"> Thru penetration fire stop systems protecting rated horizontal assemblies shall have an F and a T rating of 1 hour or equal to the rated assembly 	712.4.1.1.2	Visually inaccessible, Need further investigation								
13.	Interior Finish	803.1									
	<ul style="list-style-type: none"> Wall and ceiling finishes per ASTM E-84, Class A, B & C / NFPA 286 										
	<ul style="list-style-type: none"> Flame spread Req <table border="0"> <tr> <td><u>Area Served</u></td> <td><u>Rating</u></td> </tr> <tr> <td>Exit Enclosures</td> <td>B</td> </tr> <tr> <td>Corridors Serving A Occupancy</td> <td>B</td> </tr> <tr> <td>Other rooms & corridors</td> <td>C</td> </tr> </table>	<u>Area Served</u>	<u>Rating</u>	Exit Enclosures	B	Corridors Serving A Occupancy	B	Other rooms & corridors	C	Table 803.9	
<u>Area Served</u>	<u>Rating</u>										
Exit Enclosures	B										
Corridors Serving A Occupancy	B										
Other rooms & corridors	C										
	<ul style="list-style-type: none"> Suspended acoustical ceilings per ASTM C 635 or C636 	808.1.1.1	?								
	<ul style="list-style-type: none"> Class I or Class II interior floor finish req'd in all exit route 	804.4.1	?								
14.	Automatic Sprinkler system – per MEP analysis	903.2.1.3	OK								
15	Means of Egress										
	<ul style="list-style-type: none"> Occupant load Is established in Figure 1 based upon the area under consideration divided by an occupant load factor 	Table 1004.1.1	OK								
	<ul style="list-style-type: none"> Egress width 	1004									
	<ul style="list-style-type: none"> o Considered for floors individually 	1004.4	OK								
	<ul style="list-style-type: none"> o Stairways – factor .3 in 	1005.1									
	<ul style="list-style-type: none"> o Other egress component – factor .2 in 		OK								
	<ul style="list-style-type: none"> Lighting 	1006.2	Noted in Elect Section								
	<ul style="list-style-type: none"> o 1 fc –at walking surfaces f exit access, exits, and exit discharge 										
	<ul style="list-style-type: none"> o 10 fc – at walking surface of stairs during use 										
	<ul style="list-style-type: none"> o Emergency power 90min min 	1006.4									
	<ul style="list-style-type: none"> Accessible means of egress 	1007.1									
	<ul style="list-style-type: none"> o Accessible means of egress are not required in alterations to existing buildings 	1007.1 Ex 1	OK								
	<ul style="list-style-type: none"> Doors 										
	<ul style="list-style-type: none"> o Shall have a clear width of at least 32 in and no door leaf shall be greater than 48 in – all egress doors exceed required width 	1008.1.1	OK								
	<ul style="list-style-type: none"> o With limitations, egress doors may include: 	1008.1.4	OK								

	Subject	CBC Reference	Notes
	<ul style="list-style-type: none"> ▪ Revolving doors ▪ Power-operated doors ▪ Access-controlled doors 		
	<ul style="list-style-type: none"> ○ Panic hardware is required on exit doors from <ul style="list-style-type: none"> ▪ A occupancies ▪ Elect rooms rated over 1200 A – check with Electrical. 	1008.1.10	OK
	<ul style="list-style-type: none"> • Stairways 		
	<ul style="list-style-type: none"> ○ Min width is 44 in unless serving fewer than 50 people, except accessible egress stairs ○ Handrails may extend 4 ½” from stair wall into req’d clear width 	1003.3.3 1012.7	OK
	<ul style="list-style-type: none"> ○ At accessible egress stairs, the stairs are req’d to have a min clear width between handrails of 48 in min width is 44 in unless serving fewer than 50 people, except accessible egress stairs 	7.2.12.2.3	n/a per 1007.1 Ex. OK
	<ul style="list-style-type: none"> ○ Min headroom clearance is 80 in 	1009.2	OK
	<ul style="list-style-type: none"> ○ Riser height <ul style="list-style-type: none"> ▪ Min 4 in, Max 7 in 	1009.3	OK
	<ul style="list-style-type: none"> ○ Ramps (for exiting) ○ Max slope – 1:12 ○ Max cross slope – 1:48 ○ Max vert rise – 30 in ○ Ramps with rise greater than 6 in shall have handrails on both sides 	1010.3 1010.4 1010.8	n/a OK
	<ul style="list-style-type: none"> • Handrails and guards 		
	<ul style="list-style-type: none"> ○ Shall be provided on both sides of stairs and ramps with risers grater than 6 in 	1009.10	Need further review
	<ul style="list-style-type: none"> ○ Intermediate handrails to be provided so that all parts of egress capacity on stairs and ramps area within 30 in of a handrail 	1012.8	
	<ul style="list-style-type: none"> ○ Guards required on elevated surfaces with an adjacent droop more than 30 in 	1013.1	
	<ul style="list-style-type: none"> ○ Guards to be 42 in high min 	1013.2	
	<ul style="list-style-type: none"> ○ Not allow a 4 in diameter sphere to pass 	1013.3	
	<ul style="list-style-type: none"> • Exit Signs 		
	<ul style="list-style-type: none"> ○ Not required in rooms or areas requiring only one exit 	1011.1	OK
	<ul style="list-style-type: none"> ○ Required at exit and exit access doors and other areas so that no place in a corridor is more than 100 ft from an exit sign 	1011.1	OK
	<ul style="list-style-type: none"> ○ Exit sign may be either internally or externally illuminated 	1011.2	OK
	<ul style="list-style-type: none"> ○ Illumination required to be on emergency power with 90 min duration 	1011.5	OK
	<ul style="list-style-type: none"> • Exit Access 		
	<ul style="list-style-type: none"> ○ Egress shall not pass through adjoining rooms except where such rooms are accessory to the area served, are not high-hazard, and provide a discernible path to an exit 	1014.2	OK
	<ul style="list-style-type: none"> ○ When two or more exits are required, they shall be separated by one third the diagonal dimension of the space <ul style="list-style-type: none"> ▪ fmr Council – 2 exits provided ▪ Mech room – 2 exits provided 	1015.1 1015.1 1015.3	OK
	<ul style="list-style-type: none"> • Travel Distance 		
	<ul style="list-style-type: none"> ○ Max allowable travel distance from any location to an exit 		
	A3: 250 ft (w/ fully-sprinklered)	Table	OK

	Subject	CBC Reference	Notes
	B: 300 ft (w/ fully-sprinklered)	1016.1	
	<ul style="list-style-type: none"> • Common path of travel distance <ul style="list-style-type: none"> ○ The max allowable common path of travel distance from any location to a point where occupants have a choice between two separate exit paths is limited to 100 feet for Group B and S 	1014.3	OK
	<ul style="list-style-type: none"> • Corridors in sprinkler protected B or S may be non-rated <ul style="list-style-type: none"> ○ Corridor width to be OL x 0.2 but not less than 44" ○ 36" with a required occupant capacity of less than 50 	Table 1018.1	OK
	<ul style="list-style-type: none"> ○ Dead ends may not exceed 50 feet in B 	1005, 1018.2, 1018.2 Ex	OK
	<ul style="list-style-type: none"> • Min number of exits <ul style="list-style-type: none"> ○ OL 1-500 – 2 exits required 	1021	OK
	<ul style="list-style-type: none"> • Vertical Exit Enclosures <ul style="list-style-type: none"> ○ Required rating – 1-hr ○ A max of 50% of exit capacity is permitted to egress through areas in the level of discharge w/ three conditions check (1.2 floor rating of 3" conc) ○ Stairs to the building permit counter should not be used for egress, to be "communicating stair" 	1022.1, 1027.1 Ex	Adjust exit sign accordingly
	<ul style="list-style-type: none"> • Exterior Exit Stairs and Ramps <ul style="list-style-type: none"> ○ Exterior exit stairways can be used in a means of egress ○ Must be open at one side ○ Not required to have separation per exceptions 	1026.2, 1026.3, 1026.6 Ex.	OK, OK, OK
	<ul style="list-style-type: none"> • Exit Discharge <ul style="list-style-type: none"> ○ A max of 50% of exit capacity is permitted to egress through areas in the level of discharge w/ three conditions check 	1027.1 Ex	OK
16	Roof Assembly and Rooftop Structures		
	<ul style="list-style-type: none"> • Roofing Classifications – Class A is required per City of Cupertino Ordinances 	Table 1505.1	Classification of (E) roof assembly is unknown.
	<ul style="list-style-type: none"> • Existing roof replacement – more than 50% of the total roof area is replaced within any one-year period, the entire roof covering of every new structure, and any roof covering applied in the alteration, repair, or replacement of the roof of every existing structure shall be a fire-retardant roof covering that is at least Class C 	1505.1.3	To be Class A per City of Cupertino Ordinances

Exhibit 4B - Accessibility for Existing Buildings

This Exhibit is prepared to summarize the required accessibility upgrade for the existing buildings per 2010 CBC.

	Subject	CBC Reference	Notes
1.	Accessibility for Existing Buildings	1134B	
	<ul style="list-style-type: none"> • Provisions apply to renovation, structural repair, alteration and addition to existing buildings • No decreased accessibility of existing buildings • Requirements shall apply only to the area of specific alteration structural repair of addition <ul style="list-style-type: none"> ○ Primary entrance to the building ○ Primary path of travel to the specific area of alteration, structural repair or addition ○ Followings that serves the area of alteration, structural repair or addition <ul style="list-style-type: none"> ▪ Sanitary facilities ▪ Drinking fountains ▪ Signs ▪ Public telephone 	1134B.1 1134B.2	
	<p>Exceptions #1</p> <ul style="list-style-type: none"> • Total construction cost does not exceed \$128,410.86 (Jan 2010) • Unreasonable hardship is where exceeds 20% of the cost of the project without these features (disproportionate cost) • Access shall be provided to the extent that it can be within 20% of the cost of project • Priority is to these elements that will provide the greatest access following order <ul style="list-style-type: none"> ○ An accessible entrance ○ An accessible route to the altered area ○ At least one accessible restroom for each sex ○ Accessible telephones ○ Accessible drinking fountains ○ When possible, additional accessible elements; parking storage and alarms • 3 years duration of accumulated cost when there are many small work • Alterations after Jan 1992 shall be considered in determining if the cost of providing a accessible path of total is disproportionate <p>Exceptions #2</p> <ul style="list-style-type: none"> • n/a - Re: privately funded project <p>Exceptions #3</p> <ul style="list-style-type: none"> • Accessibility improvement work itself is limited to the actual work of the project <p>Exceptions #4</p> <ul style="list-style-type: none"> • Work limited to <ul style="list-style-type: none"> ○ HVAC ○ Re-roofing ○ Electrical (not included switches and receptacles) ○ Cosmetic work 	1134.2.1 Ex.	
	<ul style="list-style-type: none"> • Alternative uni-sex per floor will be permitted if technically infeasible 	1134B.2.2	

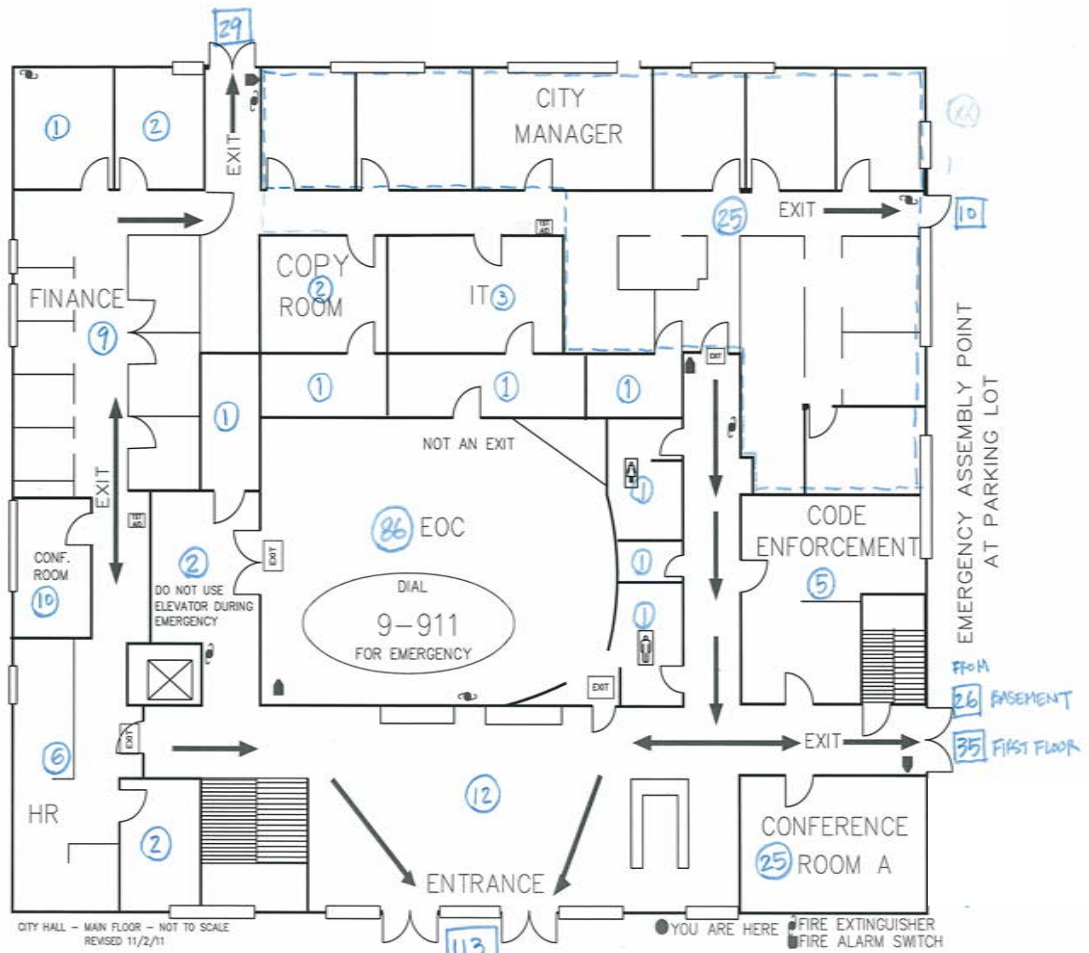

Exhibit 4C First Floor Occupancy Load and Exit Diagram

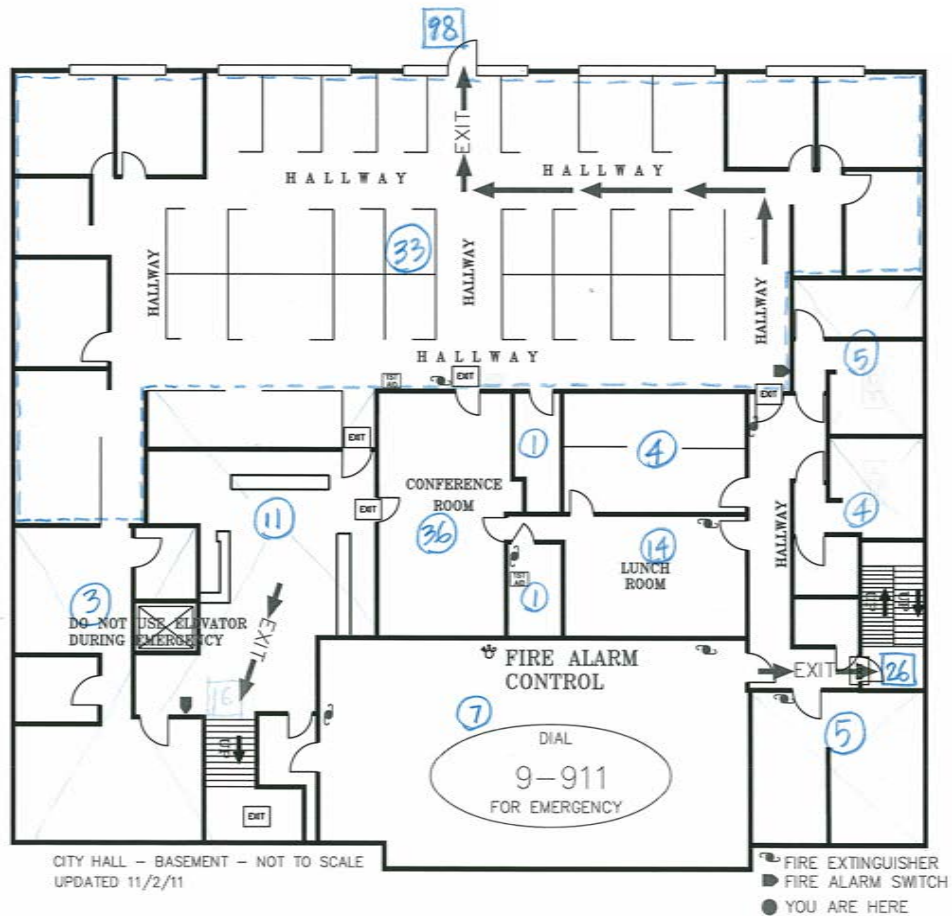

Exhibit 4D Basement Floor Occupancy Load and Exit Diagram

5.0 Mechanical, Electrical, Plumbing, Fire Protection Analysis

5.1 Scope

The main goal of this report is to evaluate the MEP equipment and infrastructure serving the Cupertino City Hall and the EOC. The evaluation of the existing MEP systems is being performed according to the following overall facility improvement alternatives:

- Alt #1 No Upgrade - Relocation of EOC
- Alt #2 Min Seismic Upgrade – Duct, pipe, and equipment seismic support (per I factor change)
- Alt #3 Moderate Upgrade - Alt #2 items, Fire & Life Safety upgrade to meet 2010 CBC, MEP upgrade to meet operation requirements as Essential Services Facilities, Energy efficiency to meet performance of the existing building
- Alt #4 Replacement – New Building

5.2 Applicable Codes and Standards

Codes:

State of California Code of Regulations (CCR).

2010 California Building Code.

2010 California Electrical Code.

2010 California Mechanical Code.

2010 California Plumbing Code.

2010 California Fire Code.

2010 California Energy Code, Title 24 – 2008

2010 California Green Code, CALGreen

City of Cupertino Municipal Code

Standards:

ASHRAE Standard 62.1-2010 – Ventilation

ASHRAE Standard 55-2010 – Thermal Comfort

ASHRAE Standard 90.1-2010: Energy Standard for Buildings except Low-Rise Residential Buildings

AMCA – Air Movement and Control Association International, Inc.

ANSI – American National Standards Institute.

ARI – Air Conditioning and Refrigeration Institute.
SMACNA – Fire and Smoke Damper Installation Guide.
SMACNA – Guidelines for Seismic Restraints of Mechanical Systems.
SMACNA – Standards for Duct Construction.
NEMA – National Electrical Manufacturer’s Association.
NEMA - National Electrical Manufacturers Association.
NECA - National Electrical Contractors Association.
IEEE - Institute of Electrical and Electronic Engineers.
UL – Underwriters Laboratories.
NFPA - National Fire Protection Association.
NFPA 90A – Air Conditioning and Ventilating Systems.
NFPA 101 – Life Safety Code.
NFPA 13 – Standard for the Installation of Sprinkler Systems.

5.3 Mechanical HVAC Systems

5.3.1 Heating and Cooling Systems

The HVAC system for the Cupertino City Hall consists of a water-cooled chiller plant (70 Ton) with the cooling tower located on the roof and the chiller located on the lower level. A gas fired non-condensing boiler generates heating hot water. The boiler is from the 1965 original building construction and is well past its life time. Both of these systems provide chilled and heating hot water to the Air Handling Units (AHU’s) located at the lower level that heat and cool the building through a VAV reheat design. All equipment was installed in ~1986 and is now 26 years old and at the end of its useful life. While the equipment appears to be well maintained, and the AHU’s have been retrofitted with VFD’s, the building operates inefficiently at a rate of \$3.63/SF-Year and 106 kBTU/SF-Year (based on 2009 utility bills). A modern, energy efficient office building operates at \$1.50/SF-Year and 50 kBTU/SF-Year.

The Cupertino City Hall has a small server room that is cooled by split system AC units, with air-cooled condensers located on the roof. The AC units for the server room appear to have been installed more recently than the rest of the HVAC equipment.



Figure 5A (Closed-Circuit 70 Ton Cooling Tower)



Figure 5B (Water-cooled 70 Ton Chiller)

In the lower level mechanical room, maintenance clearances and an exit pathway may not exist throughout the space. In addition, the combination of chiller, gas boiler, electrical gear, and generator equipment do not meet today's code

requirement to have separate rooms for each of these pieces of equipment. The room is also not equipped with a refrigerant detection and exhaust systems currently required for chiller rooms, and the combustion air ducts in the boiler room need to be routed to an outdoor location.



Figure 5C (Gas Fired Boiler)



Figure 5D (Server room AC unit (1 of 2))

Recommendations

Alt #1 No Upgrade: No work.

Alt #2 Min Seismic Upgrade: Upgrade all duct, pipe, and equipment anchorage and seismic attachments to building structure. Replace duct and pipe connections with flexible joints where required.

Alt #3 Moderate Upgrade: Replace existing HVAC equipment with smaller, more efficient, better comfort equipment design.

Alt #4 Replacement: New HVAC systems for new building.

5.3.2 Ventilation

The existing AHU's air intake is located in an airwell that does not provide good air quality air for building occupants. The amount of fresh air brought into the building is not enough by today's standards and codes, and should be increased and improved.

Recommendations

Alt #1 No Upgrade: No work.

Alt #2 Min Seismic Upgrade: No work.

Alt #3 Moderate Upgrade: Obtain fresh air from a different location (i.e. roof louvers) and increase amount of fresh air.

Alt #4 Replacement: New HVAC systems for new building.

5.3.3 Controls

The existing control system is an outdated pneumatic system that does not allow for remote monitoring or the implementation of common energy efficiency strategies in modern buildings. In addition the pneumatic controls system requires more maintenance to upkeep the compressor, air filter, and other mechanical systems required to run the system.

Recommendations

Alt #1 No Upgrade: No work.

Alt #2 Min Seismic Upgrade: No work.

Alt #3 Moderate Upgrade: Replace existing system with modern DDC controls system.

Alt #4 Replacement: New HVAC systems for new building.

5.4 Plumbing Systems

5.4.1 Plumbing Fixtures

The existing plumbing fixtures are functioning and meet current code.

Recommendations

Alt #1 No Upgrade: No work.

Alt #2 Min Seismic Upgrade: No work.

Alt #3 Moderate Upgrade: No work.

Alt #4 Replacement: New plumbing systems and fixtures for new building.

5.4.2 Domestic Water System

The domestic water piping appears to be copper. An AO Smith boiler gas fires water heater provide domestic hot water to all building plumbing fixtures. The water heater appears to have been installed with the last 5 years.

Recommendations

Alt #1 No Upgrade: No work.

Alt #2 Min Seismic Upgrade: Upgrade all plumbing pipe and equipment anchorage and seismic attachments to building structure.

Alt #3 Moderate Upgrade: Replace existing plumbing pipe (cold and hot water). Replace existing water heater with a high efficiency heat pump water heater.

Alt #4 Replacement: New plumbing systems and fixtures for new building.

5.5 Fire Protection Systems

5.5.1 Fire Sprinkler system

The building is fully sprinklered and testing station appears to be in proper operating condition given the test log dates.

Recommendations

Alt #1 No Upgrade: No work.

Alt #2 Min Seismic Upgrade: Upgrade all fire protection pipe and equipment anchorage and seismic attachments to building structure.

Alt #3 Moderate Upgrade: Replace existing pipe and sprinkler heads inside building to match renovation intent.

Alt #4 Replacement: New fire protection system for new building.

5.6 ELECTRICAL

5.6.1 Electrical Systems Summary

This report is an evaluation of the Cupertino Essential Services building electrical systems, located at Rodrigues and Torre Avenue, in Cupertino, California. The data used to develop this report was collected during one site visit conducted on February 15, 2012, as well as interviews of the staff working at the building. During the field visit, we observed the site conditions and systems exposed to visual observation. No testing or destructive investigation was performed.

Additional information about the building's power distribution system was gathered by reviewing the building plan sets made available in PDF format. The walk through was intended to evaluate the effectiveness of the existing Electrical systems.

This report provides an overview of existing conditions of the electrical system, identification of potential weaknesses in the systems and suggested improvements to the systems.

All major electrical equipment appear to be original and in working condition. The main distribution equipment is nearly 47 years old and has past its expected useful life. The generator is nearly 34 years old and has passed its useful life.

The existing light fixtures are in serviceable condition. As a possible energy saving project, the building management may want to consider replacing the existing lights with more energy efficient T5, T8, LED, and compact fluorescent fixtures. Another energy saving technique would be to upgrade the lighting control system and incorporate occupancy sensors and/or daylight sensors in addition to using time clock controls.

The main service to the City Hall space is a rated at 1000A at 208V, 3-phase system and provides power for a load density of approximately 12.5 W (or 15.5 VA, using 0.8 power factor) per square foot for the entire building, which is adequate for the current loads.

5.6.2 Assessment of Existing Conditions

Normal Power

Utility Transformer

The building is fed from a utility transformer (PG&E) located outside the building.



Figure 1E (PG&E Transformer)

The secondary power from the transformer to the main switchboard is provided via (4) sets of 4" underground conduits.

The main switchboard is rated 1600A, 208/120V, 3-phase, 4-wire and is located inside the main electrical room.

General Condition

The transformer belongs to PG&E and was recently upgraded. It appears to be in good working condition.

Code Issues

No code issues.

Recommendation:

Alt #1 No Upgrade: No work.

Alt #2 Min Seismic Upgrade: Confirm with PG&E if the new transformer meets current Seismic code

Alt #3 Upgrade: No work. Transformer was recently upgraded.

Alt #4 Replacement: Transformer was recently upgraded.

Main Switchboard

The Main Switchboard is rated at 2000A, 120/208V, 3 phase, 4 wire with a 1600A main breaker manufactured by Industrial Electric Manufacturing, Inc. The main switchboard is feeding a distribution panel via a 1,000Amp breaker. This switchboard serves the City Hall.

The table below summarizes the load on each panel.

Table 5.1 (Panel Load)

Name	Size	Load Serving
MSB	2000A Section	Library, Future Public Safety Building, ATS for Generator
Panel DP	1000A Section	PANEL F, PANEL C, PANEL A, PANEL E, PANEL B, PANEL D, PANEL G (MCC) CHILLER, Future E.O.C. Panel
G (MCC)	600A	Pump 1, 2, 3, 4, 5, 6, Cooling Tower Fan A/C Fan Basement A/C Fan 1 st Floor A/C Fan 1 st Floor Remote Radiator Fuel Pump



Figure 5F (Main Switchboard)

General Condition

The main switchboard appears to be of the original construction and in working condition, although past its useful life. In general, the switchboard is adequately sized to support the existing loads.

Code Issues

Maintenance clearances and exit pathway are required to be investigated around the 1600 Amp electrical panel. Electrical panel is over 1200 Amps, thus requiring either (A) 2 exits with panic hardware, or (B) 1 exit door with panic hardware but a clear and unobstructed path from Panel to exit door, or (C) a single exit door with panic hardware but double the required working space around the Panel.

Recommendation

Alt #1 No Upgrade: No work.

Alt #2 Min Seismic Upgrade: Provide adequate support suitable for the seismic and earthquake condition.

Alt #3 Upgrade: The existing main distribution switchboard shall have regular preventative maintenance procedure per NETA (National Electrical Testing Association) standards.

Megger test existing feeders.

Test overcurrent protective devices in the switchboard for proper operation.

Alt #4 Replacement: In order to ensure reliable power distribution to the building and reduce service needs in the future, we recommend the main switchboard be replaced with a new model.

5.6.3 Emergency Power

The emergency power system consists of a generator rated at 125KW, 208/120V and is located inside the main electrical room. The fuel tank, with 1000 gallon capacity, is located outside the room. In the event of a power outage, the generator provides power to the panel DP via a 400A automatic transfer switch (ATS) located in the main electrical room. The generator also provides power to the Chiller but the pump must be “jump” to move chilled water. The generator does not serve the existing elevator. or the chiller, as confirmed by discussions with facility personnel.



Figure 5G (Indoor Generator)

General Condition

The generator was installed in 1978, making it nearly 34 years old, which has exceeded its useful life. It appears to be operational, as confirmed by facility personnel.

Code Issues

No code issues

Recommendation

Alt #1 No Upgrade: No work.

Alt #2 Min Seismic Upgrade: Provide adequate support suitable for the seismic and earthquake condition.

Alt #3 Upgrade: The generator should at the minimum be tested per manufacturer's recommendation to confirm its operation, and the batteries tested to confirm capacity and condition as well.

Alt #4 Replacement: The existing generator is currently loaded to its full capacity. In order to increase reliability and provide assurance of operation in the future, it is recommended that the generator be replaced with a new unit. We also recommend upsizing the generator to 175kW or above and its associated automatic transfer switch to 500A or above to provide capacity to serve additional loads such as the elevator and any future loads.

5.6.4 Grounding System

The service ground was not readily visible at the Main Switchboard. Feeder and branch circuit ground conductor sizes were not verified. Bonding to the building mechanical systems was not confirmed.

General Condition

No hazard has been identified with the current grounding system.

Recommendations

Alt #1 No Upgrade: No work.

Alt #2 Min Seismic Upgrade: No work

Alt #3 Moderate Upgrade: The grounding electrode resistance should be verified and supplemented as needed with additional ground rods. The mechanical and plumbing system bonding should be verified.

Alt #4 Replacement: Provide new grounding system to meet current code.

5.6.5 Lighting

Interior Lighting

The existing lighting system consists mostly of recessed and pendant mounted fluorescent linear T8 32/26 watts source fixtures, with additional recessed incandescent downlight fixtures.

Illumination levels were observed to be uniform and adequate in all common area corridors, offices, work areas, and equipment rooms. Emergency exit signs are provided throughout the building according to Code. Emergency and egress lighting is provided by selected normal fixtures fed by emergency circuits from the generator. Exit lights are LED with battery back-up. Bug-eye type supplemental emergency fixtures was provided in the boiler room.

General Condition

Light fixtures appear to date back to the original construction and are in fair condition, with no operational issues.

Code Issues

Perform functional testing of all existing emergency lighting and measure light levels for code compliance.

Install additional emergency lighting as necessary after the functional testing of the existing installation to provide current code required minimum egress illumination.

Recommendations

Alt #1 No Upgrade: No work.

Alt #2 Min Seismic Upgrade: Provide adequate support suitable for the seismic and earthquake condition.

Alt #3 Moderate Upgrade: If improvements to the lighting system are to occur, the existing outmoded T12 source fixtures should be replaced with new higher efficiency T8, T5 or LED source fixtures to reduce energy usage. Newer fixtures will also provide better light distribution and higher uniformity to increase occupant comfort. Any existing incandescent source fixtures should be replaced with higher efficiency compact fluorescent source fixtures.

Alt #4 Replacement: Similar to Alternative 3

5.6.6 Lighting Controls

The existing general lighting is controlled by local switches located within the corridors and at the each room. Lighting in the Kitchen, bathrooms, stairwell and conference room "A" is controlled by motion sensors. Relay control panels provide time schedule control for corridors and general areas, and dimming equipment provides dimming functionality to meeting rooms.

Recommendation

Alt #1 No Upgrade: No work.

Alt #2 Min Seismic Upgrade: Provide adequate support suitable for the seismic and earthquake condition.

Alt #3 Moderate Upgrade: Ceiling mounted occupancy sensors can be added to individual rooms to automatically switch on one-half or all of the fixtures when occupancy is detected and switch off all fixtures when no one is present, to take advantage of irregular occupancy intervals. A time delay of 30 minutes or less can be used to minimize nuisance switching.

To meet current code, reduce energy use, and increase the effectiveness and flexibility of the lighting installation, it is recommended that automatic and multilevel lighting controls be installed in every space.

Alt #4 Replacement: As the perimeter office areas receive good access to daylight, ceiling mounted photosensors may used to provide automated dimming of the perimeter fixtures according to the amount of daylight available, further reducing the lighting load. The existing fluorescent source fixtures within the

perimeter daylight area will need to be provided with dimming ballasts in order to integrate with the photosensor input.

In addition, both occupancy sensing and daylight harvesting through photosensors can be employed together. This will keep lights off when the space is unoccupied and also dim the light output when sufficient daylight is available in order to maximize the energy saving potential.

This page intentionally left blank.

This page intentionally left blank.

APPENDIX A - 10

Cupertino City Hall: MEP Systems Alternatives Study
(PAE, Oct 2, 2014)

Cupertino City Hall: MEP Systems Alternatives Study

October 7, 2014

This page intentionally left blank.



Contents

1.0	Project Description.....	1
2.0	OPTION A - UPGRADE CITY HALL WITH LIFE SAFETY.....	1
2.1	Electrical.....	1
2.2	Mechanical.....	1
2.3	Plumbing.....	2
2.4	Fire Protection.....	2
2.5	Indirect Costs.....	2
3.0	OPTION B - UPGRADE CITY HALL WITH LIFE SAFETY + EOC.....	2
3.1	Electrical.....	2
3.2	Mechanical.....	2
3.3	Plumbing.....	3
3.4	Fire Protection.....	3
3.5	Indirect Costs.....	3
3.6	Floodplain Considerations.....	3
4.0	OPTION C - GUT AND REMODEL CITY HALL.....	3
4.1	Electrical.....	3
4.2	Mechanical.....	4
4.3	Plumbing.....	4
4.4	Fire Protection.....	4
4.5	Indirect Costs.....	4
4.6	Floodplain Considerations.....	5
5.0	OPTION D - NEW CITY HALL BUILDING + BASEMENT PARKING.....	5
5.1	Electrical.....	5
5.2	Mechanical.....	5
5.3	Plumbing.....	5
5.4	Fire Protection.....	6
5.5	Indirect Costs.....	6
5.6	Floodplain Considerations.....	6
6.0	OPTION E - NEW CITY HALL BUILDING + BASEMENT PARKING + COUNCIL CHAMBERS.....	6
6.1	Electrical.....	6
6.2	Mechanical.....	6
6.3	Plumbing.....	6
6.4	Fire Protection.....	6
6.5	Indirect Costs.....	6
6.6	Floodplain Considerations.....	6
7.0	ENERGY BENCHMARKING.....	6



Project Directory

Owner

City of Cupertino
10300 Torre Avenue
Cupertino, CA 95014
408-777-3200

Architect

Project Architect
2 Bryant Street, Suite 300
San Francisco, CA 94105
415-856-3000

Karen Alschuler
Principal-in-Charge
Karen.Alschuler@perkinswill.com

Geeti Silwal, LEED AP BD+C
Associate Principal, Senior Project Manager
Geeti.Silwal@perkinswill.com

Mechanical & Electrical Engineer

PAE Consulting Engineers, Inc.
425 California Street, Suite 1200
San Francisco, CA 94104
415-544-7500

Mike Lucas, PE, LEED AP
Principal-in-Charge
michael.lucas@pae-engineers.com

Marco Alves, PE, LEED AP
Project Manager
marco.alves@pae-engineers.com

Harj Sidhu, PE, LEED AP
Electrical
harjot.sidhu@pae-engineers.com

Stuart Gregson, PE, LEED AP
Mechanical
stuart.gregson@pae-engineers.com



1.0 Project Description

This report is a follow up to the "Cupertino City Hall Essential Services Facility Analysis" report produced on 3/27/2012 by Perkins + Will, AKH Structural Engineers, and PAE. Refer to the 2012 report for details information on existing systems.

At this time the design team is considering 5 options for the city hall building:

1. Option A – Upgrade city hall with life safety
2. Option B – Upgrade city hall with life safety + EOC
3. Option C – Gut and remodel city hall
4. Option D – New city hall building with basement parking
5. Option E – New city hall building with basement parking + council chambers

The following sections outline the Mechanical, Electrical, and Plumbing implications of each of the above options. TBD Consultants has been engaged to provide cost estimates of each of these options.

2.0 OPTION A - UPGRADE CITY HALL WITH LIFE SAFETY

2.1 Electrical

Existing Electrical equipment including Main Switchboard, panelboards, etc. are all well past their useful life. Replace all Electrical distribution equipment.

Existing wiring to be removed and new wiring to be pulled through new conduit.

Upgrade Fire Alarm to meet the latest Life Safety requirements.

Provide new lighting fixtures to meet the latest T24 requirements. Emergency power for egress fixtures, via local battery packs.

2.2 Mechanical

Demo existing 70-ton, 1986 vintage water cooled chiller in lower level mechanical room.

Demo existing 70-ton, closed circuit, 1986 vintage rooftop cooling tower.

Demo 1965 vintage gas fired non-condensing boiler in lower level mechanical room.

Demo lower level 1986 vintage VAV+ reheat air handling unit.

Add new 70 ton air-cooled chiller at roof/attic level.

Add (2) 400,000 Btu (input capacity) condensing boilers at basement level.

Add new pipe and pumps for chilled and hot water systems.

Add (2) new AHUs to basement level (15,000 cfm each).



Clean and reuse existing ductwork as much as possible.

Increase ventilation rate to today's standards, re-route ventilation air intake.

Demolish existing pneumatic VAV boxes.

Provide new VAV boxes with direct digital controls.

Provide new BMS with DDC controls for all equipment and terminal units with front end for basic control and monitoring functions.

2.3 **Plumbing**

Miscellaneous upgrades for ADA compliance per September 2014 ADA report, including repositioning toilet heights and correcting lavatory/drinking fountain access.

2.4 **Fire Protection**

Modify sprinklers for code updates.

2.5 **Indirect Costs**

Cost of building/locating the EOC elsewhere on campus. Council Chambers remains at the Community Hall. The operations of the facility is not included in the costing.

3.0 OPTION B - UPGRADE CITY HALL WITH LIFE SAFETY + EOC

3.1 **Electrical**

Existing Electrical equipment including Main Switchboard, panelboards, transformers etc. are all well past their useful life. Replace all Electrical distribution equipment.

Existing wiring to be removed and new wiring to be pulled through new conduit.

Existing Generator is well past it's useful life. Replace with new generator.

Evaluate Generator capacity versus the latest EOC requirements. Minimum generator size to be 125kW to match existing size.

Upgrade Fire Alarm to meet the latest Life Safety requirements.

Provide new lighting and lighting controls to meet the latest T24 requirements. Emergency power for egress fixtures, via local battery packs.

3.2 **Mechanical**

Same points as Option A, also including the following:

Upgrade all duct, pipe, and equipment anchorage and seismic attachments to building structure. Replace duct and pipe connections with flexible joints throughout. All large equipment shall be spring isolated.

AHU to be placed in attic level or roof. Preliminary selection indicates (2) AHU's at 7'W x 28'L x 5'H (10,000 lbs each).



Boiler to be placed at roof level.

Add HVAC heating to generator load (AHU, Boiler, Pumps, will be on emergency power, connected to the generator).

3.3 **Plumbing**

Miscellaneous upgrades for ADA compliance per September 2014 ADA report, including repositioning toilet heights and correcting lavatory/drinking fountain access.

Upgrade all plumbing equipment and pipe anchorage and seismic attachments to building structure.

3.4 **Fire Protection**

Modify sprinklers for code updates.

Upgrade fire sprinkler pipe anchorage and seismic attachments.

3.5 **Indirect Costs**

Cost of operating the Council Chambers at the Community Hall is separate.

3.6 **Floodplain Considerations**

We understand that FEMA stipulations require that emergency equipment shall not be located within Special Flood Hazard Areas Zones A, AE, and AO (which are areas within the 100 year floodplain). The attached FEMA map shows flood plain areas in the City of Cupertino and near the project location indicating that the project location is not within the 100 year floodplain zones.

FEMA's 2007 Design Guide for Improving Critical Facility Safety from Flooding and High Winds, publication 543 (located here: http://www.fema.gov/media-library-data/20130726-1557-20490-1542/fema543_complete.pdf) advises that emergency equipment should be located above the 500 year flood elevation. While this is a design guideline and not necessarily a FEMA requirement, PAE recommends that the project design should attempt to comply with this guideline. Consideration should be given to relocating the emergency generator to a level above grade to mitigate the risk of flooding due to storm conditions or piping malfunctions within the building.

The attached map indicates that the project is within the 500 year floodplain; however it does not designate the specific elevation of the 500 year flood. PAE recommends that a qualified firm/organization should be engaged to consult on specific floodplain elevations and recommendations for FEMA compliant locations for the emergency generator.

4.0 OPTION C - GUT AND REMODEL CITY HALL

4.1 **Electrical**

Existing Electrical equipment including Main Switchboard, panelboards, transformers etc. are all well past their useful life. Replace all Electrical distribution equipment.



Provide new Electrical Distribution throughout the building. This includes new Main Switchboards, panelboards, and transformers.

Provide new conduits to distribute power.

New wiring

Existing Generator is well past it's useful life. Replace with new generator.

Evaluate Generator capacity versus the latest EOC requirements. Minimum generator size to be 125kW to match existing size.

Upgrade Fire Alarm to meet the latest Life Safety requirements.

Provide new lighting and lighting controls to meet the latest T24 requirements. Emergency power for egress fixtures, via local battery packs.

4.2 **Mechanical**

Same points as Option B, also including the following:

New thermal zoning layout.

New distribution ductwork.

New distribution piping.

Design for mixed mode natural + mechanical ventilation, possibly engaging light wells or light court for transfer air.

All new mechanical system is likely to remain an air based VAV + reheat system.

4.3 **Plumbing**

Provide new high efficiency, condensing gas water heater.

Provide all new piping for the following systems:

- a) Domestic Cold and Hot water piping
- b) Vent piping
- c) Gas piping
- d) Storm piping
- e) Waste piping

Provide new (water conserving) plumbing fixtures, ADA compliant.

4.4 **Fire Protection**

New sprinkler system.

4.5 **Indirect Costs**

Cost of operating the Council Chambers at the Community Hall is separate.



4.6 **Floodplain Considerations**

Same as Option B.

5.0 **OPTION D - NEW CITY HALL BUILDING + BASEMENT PARKING**

5.1 **Electrical**

New incoming service

New distribution

New Lighting

New Generator

New Fire Alarm

5.2 **Mechanical**

New central hydronic equipment: geothermal slinky field (60,000 sf area) below basement parking, served by water to water heat pump. Although the basement parking footprint area is planned to be 45,000 sf a 60,000 sf excavation area may be available due to shoring requirements. If needed the slinky field can extend further into (below) the site, or can be located in another location that may already be planned for excavation for other campus reasons. If desired, the slinky field can be piped so as to accommodate potential future expansion should the slinky field ever be desired for use as a campus system serving multiple buildings.

- Take advantage of federal tax savings for geothermal systems: 10% Tax Credit year 1, and 100% depreciation over 5 years.
- City of Cupertino to determine tax liability and eligibility for tax savings programs. One option may be a Thermal Purchase Agreement (TPA) in which a tax-liable 3rd party procures the geothermal system and secures the tax savings, and the City of Cupertino purchases the thermal energy from the 3rd party.

New indoor services, including radiant heating/cooling with dedicated outdoor air system.

Garage ventilation with CO sensor control.

5.3 **Plumbing**

New incoming/outgoing services for Fire, Gas, Domestic Cold Water, Storm Drain, and Waste.

New high efficiency condensing gas water heater and associated components (recirculating pump, storage tank, expansion tank, etc.)

New water conserving plumbing fixtures, ADA compliant.

New plumbing piping systems.



5.4 Fire Protection

New sprinkler system.

5.5 Indirect Costs

Cost of operating the Council Chambers at the Community Hall is separate.

5.6 Floodplain Considerations

Same as Option B.

6.0 OPTION E - NEW CITY HALL BUILDING + BASEMENT PARKING + COUNCIL CHAMBERS

6.1 Electrical

Same as Option D

6.2 Mechanical

Same as Option D, with higher ventilation rates and equipment capacities and geothermal slinky field (70,000 sf area to account for additional area of council chambers).

6.3 Plumbing

Same as Option D

6.4 Fire Protection

Same as Option D

6.5 Indirect Costs

Assume EOC included.

6.6 Floodplain Considerations

Same as Option B.

7.0 ENERGY BENCHMARKING

Based on 2013 utility bills, the existing facility operates inefficiently at an energy cost rate of \$3.65/sf-year and an Energy Use Intensity (EUI) of 92 kBtu/sf-year (based on a September 2014 study provided by the City). A modern, energy efficient new construction office building in this climate would operate at approximately \$1.20/sf-year and 35 kBtu/sf-year.

Based on PAE's project experience, Figures 1 and 2 on the next page illustrate potential reductions in energy use and energy cost associated with each of the options described in this report.



Figures 3 and 4 illustrate preliminary life cycle cost analysis and total cost of ownership for the mechanical systems described in Options A-E. In this case, the first cost of Options D and E was normalized on an area basis for equal comparison to Option A, B, and C. The Option D and E costs shown here are as if these options had the same project area as Option A, B, and C.

Figures 3 and 4 show that even though Options C, D, and E have higher first costs, the total cost of ownership over time is significantly less compared to Options A and B. The simple paybacks on Options D and E are less than 10 years, and the 30 year total cost of ownership for Options D and E are millions of dollars less than any other option. This is something to consider for the life of a project that is expected to last 30 years or more.

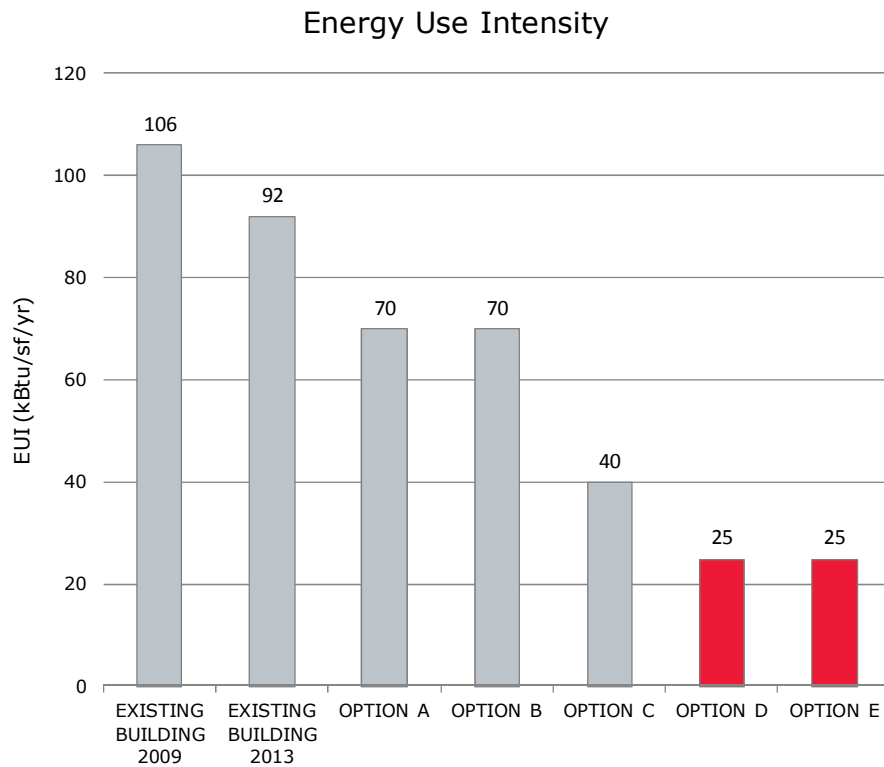

Figure 1. Energy Use Intensity (EUI) comparisons

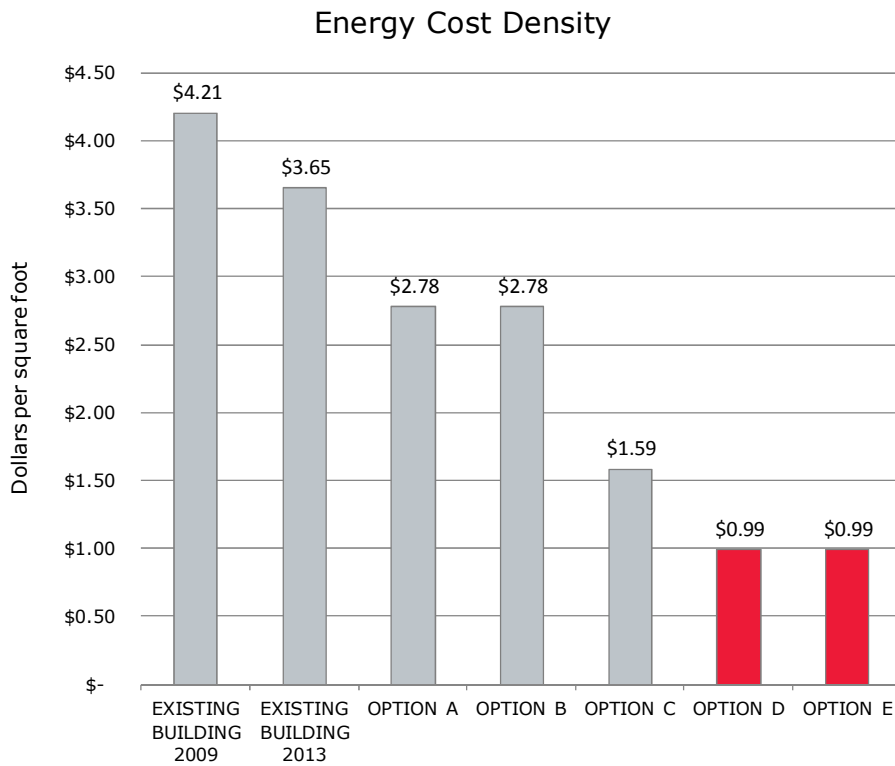

Figure 2. Energy Cost Density comparisons



LIFECYCLE COST ANALYSIS									
BASED ON 30 YEAR ANALYSIS - 2014 to 2043									
Options	OPTIONS	Capital Costs (\$) ²⁰¹⁴	Avg. Annual Maint. Costs (\$)	Avg. Annual Repla. Costs (\$)	Year 1 Utility Costs (\$) ²⁰¹⁴	Simple Payback Option A Base (Years)	15 Year Cost of Ownership (\$) ²⁰²⁸	30 Year Cost of Ownership (\$) ²⁰⁴³	Energy Use Index (kBtu/sf-yr)
A	Option A - UPGRADE CITY HALL WITH LIFE SAFETY	\$2,725,421	\$79,292	\$40,003	\$63,940	-	\$5,268,795	\$10,309,194	70
B	Option B - UPGRADE CITY HALL WITH LIFE SAFETY + EOC	\$3,065,022	\$79,292	\$40,003	\$63,940	N/A	\$5,608,396	\$10,648,795	70
C	Option C - 4.0 OPTION C - GUT AND REMODEL CITY HALL	\$3,710,142	\$47,575	\$40,003	\$36,570	16.7	\$5,290,933	\$8,523,976	40
D	Option D - 5.0 OPTION D - NEW CITY HALL BUILDING + BASEMENT PARKING	\$3,750,927	\$23,788	\$26,884	\$22,770	9.3	\$4,754,949	\$6,651,191	25
E	Option E - 6.0 OPTION E - NEW CITY HALL BUILDING + BASEMENT PARKING + COUNCIL CHAMBERS	\$3,705,176	\$23,788	\$26,884	\$22,770	8.9	\$4,709,199	\$6,605,441	25

Notes / Assumptions:

- Capital Costs are based on reports from TBD consultants, dated 10/5/14 and 10/6/14, plus PAE estimates of controls costs. Capital costs of Options D and E are normalized by project area to create an even comparison with Options A, B, C. These are the costs if a new building was built with the same area as the existing building.

Figure 3. Life Cycle Cost Analysis Results

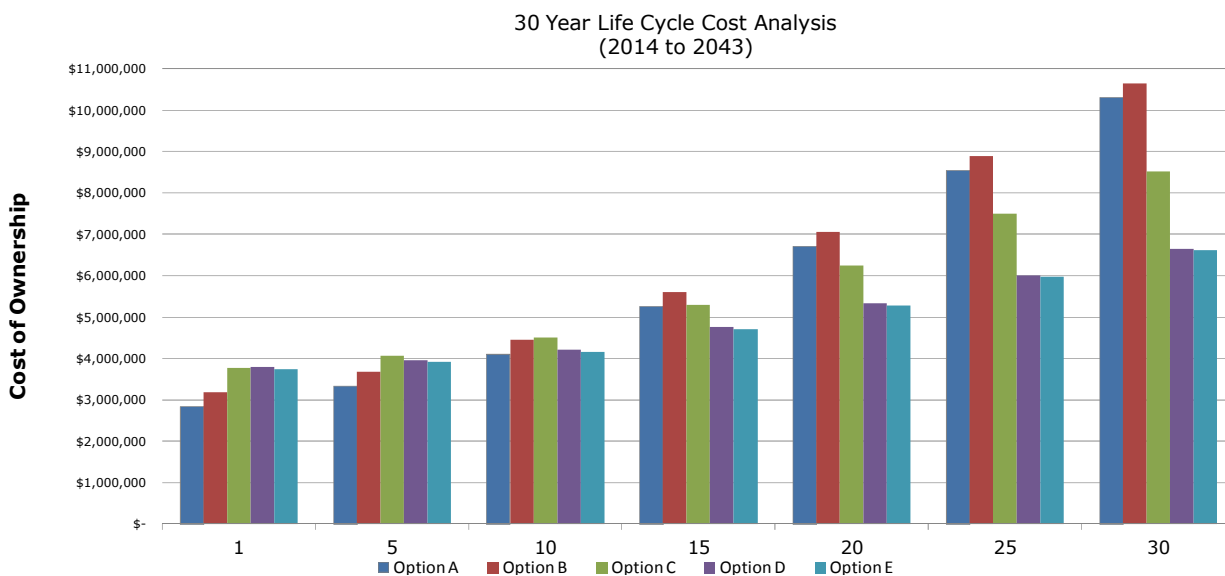

Figure 4. Total Cost of Ownership over 30 years

NOTES TO USERS

This map is for use in administering the National Flood Insurance Program. It does not necessarily identify all areas subject to flooding, particularly from local drainage sources of small size. The community map repository should be consulted for possible updates or additional flood hazard information.

To obtain more detailed information in areas where Base Flood Elevations (BFEs) and/or floodways have been determined, users are encouraged to consult the Flood Profiles and Floodway Data and/or Summary of Stillwater Elevations tables contained within the Flood Insurance Study (FIS) report that accompanies this FIRM. Users should be aware that BFEs shown on the FIRM represent rounded whole-foot elevations. These BFEs are intended for flood insurance rating purposes only and should not be used as the sole source of flood elevation information. Accordingly, flood elevation data presented in the FIS report should be utilized in conjunction with the FIRM for purposes of construction and/or floodplain management.

Coastal Base Flood Elevations shown on this map apply only landward of 0.6' North American Vertical Datum of 1988 (NAVD 88). Users of this FIRM should be aware that coastal flood elevations are also provided in the Summary of Stillwater Elevations Tables in the Flood Insurance Study report for the jurisdiction. Elevations shown in the Summary of Stillwater Elevations Tables should be used for construction and/or floodplain management purposes when they are higher than the elevations shown on this FIRM.

Boundaries of the floodways were computed at cross sections and interpolated between cross sections. The floodways were based on hydraulic considerations with regard to requirements of the National Flood Insurance Program. Floodway widths and other pertinent floodway data are provided in the Flood Insurance Study report for this jurisdiction.

Certain areas not in Special Flood Hazard Areas may be protected by flood control structures. Refer to Section 2.4 "Flood Protection Measures" of the Flood Insurance Study report for information on flood control structures for this jurisdiction.

The projection used in the preparation of this map was Universal Transverse Mercator (UTM) zone 10. The horizontal datum was NAVD 83. CR830 spherical differences in datum, spheroid, projection or UTM zone used in the projection of FIRMs for adjacent jurisdictions may result in slight positional differences in map features across jurisdiction boundaries. These differences do not affect the accuracy of this FIRM.

Flood elevations on this map are referenced to the North American Vertical Datum of 1988. These flood elevations must be compared to structure and ground elevations referenced to the same vertical datum. For information regarding conversion between the National Geodetic Vertical Datum of 1988 and the North American Vertical Datum of 1988, visit the National Geodetic Survey website at <http://www.ngs.noaa.gov> or contact the National Geodetic Survey at the following address:

NGS Information Services
NOAA, N/NGS-12
National Geodetic Survey
S/MC-1, 40202
1315 East-West Highway
Silver Spring, Maryland 20910-3282
(301) 713-3242

To obtain current elevation, description, and/or location information for bench marks shown on this map please contact the Information Services Branch of the National Geodetic Survey at (301) 713-3242, or visit its website at <http://www.ngs.noaa.gov>.

Base map information shown on this FIRM was provided in digital format by the USDA National Agriculture Imagery Program (NAIP). This information was photogrammetrically compiled at a scale of 1:24,000 from aerial photography dated 2005.

This map reflects more detailed and up-to-date stream channel configurations than those shown on the previous FIRM for this jurisdiction. The floodplains and floodways that were transferred from the previous FIRM may have been adjusted to conform to these new stream channel configurations. As a result, the Flood Profiles and Floodway Data tables in the Flood Insurance Study Report (which contains authoritative hydraulic data) may reflect stream channel distances that differ from what is shown on this map.

Corporate limits shown on this map are based on the best data available at the time of publication. Because changes due to annexations or de-annexations may have occurred after this map was published, map users should contact appropriate community officials to verify current corporate limit locations.

Please refer to the separately printed Map Index for an overview map of the county showing the layout of map panels, community map repository addresses and a listing of communities table containing National Flood Insurance Program dates for each community as well as a listing of the panels on which each community is located.

Contact the FEMA Map Service Center at 1-800-358-9913 for information or available products associated with this FIRM. Available products may include previously issued Letters of Map Change, a Flood Insurance Study report, and/or digital versions of this map. The FEMA Map Service Center may also be reached by Fax at 1-800-368-9829 and its website at <http://msc.fema.gov>.

If you have questions about this map or questions concerning the National Flood Insurance Program in general, please call 1-877-FEMA-MAP (1-877-336-2677) or visit the FEMA website at <http://www.fema.gov>.

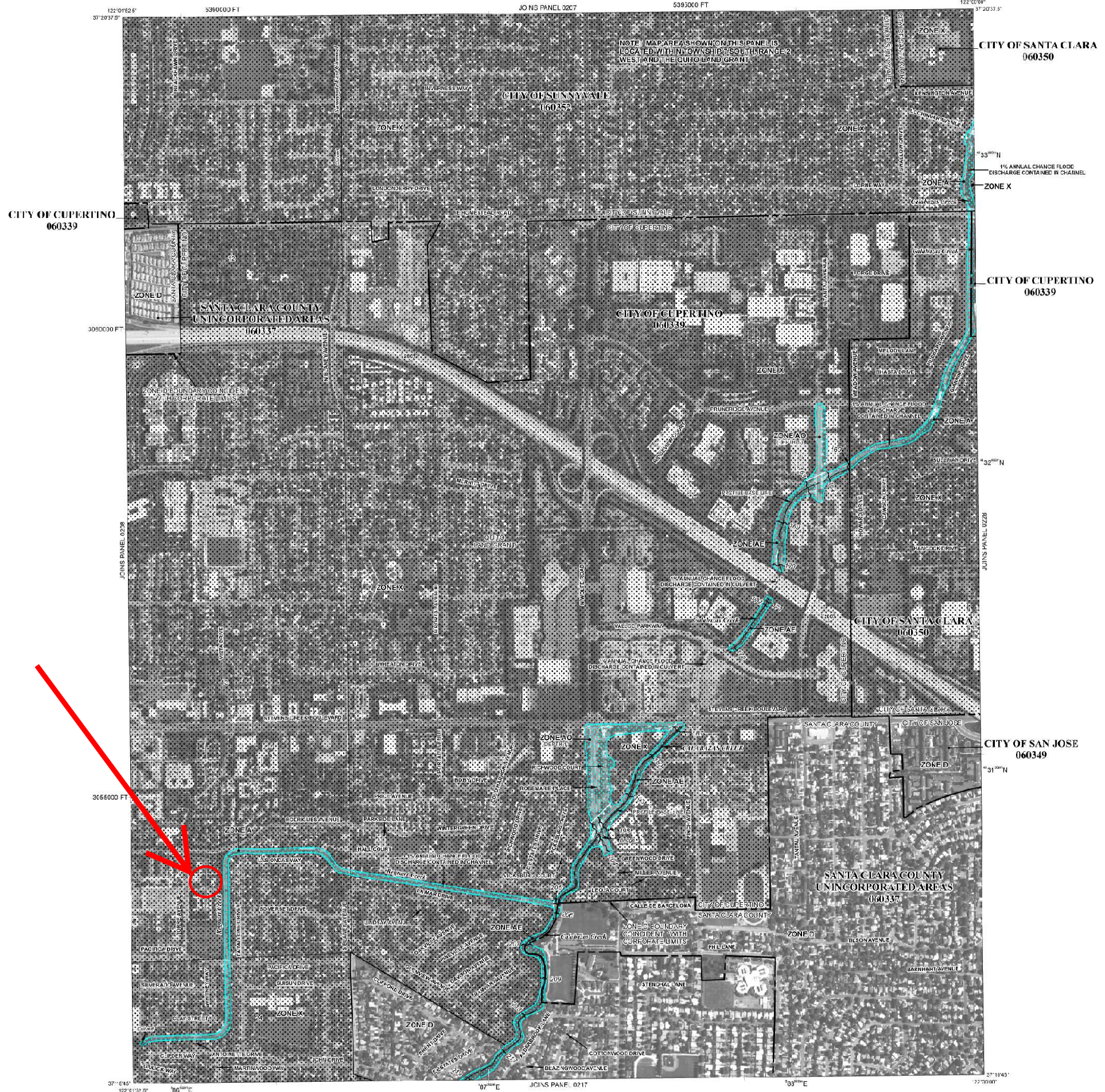

LEGEND

SPECIAL FLOOD HAZARD AREAS SUBJECT TO INUNDATION BY THE 1% ANNUAL CHANCE FLOOD

The 1% annual flood (100-year flood), also known as the base flood, is the flood that has a 1% chance of being equaled or exceeded in any given year. The Special Flood Hazard Area is the area subject to flooding by the 1% annual chance flood. Areas of Special Flood Hazard include Zones A, AE, AH, AO, AR, AR1, V, and VE. The base flood elevation is the water-surface elevation of the 1% annual chance flood.

ZONE A No Base Flood Elevation determined.

ZONE AE Base Flood Elevation determined.

ZONE AH Flood depths of 1 to 3 feet (usually areas of ponding). Base Flood Elevation determined.

ZONE AO Flood depths of 1 to 2 feet (usually street flow on soaking terrain); average depths determined. For areas of diurnal (or flood) vehicles also determined.

ZONE AR Special Flood Hazard Area formerly protected from the 1% annual chance flood by a rock control system that with subsequent sedimentation, Zone AR indicates that the former flood control system is being restored to provide protection from the 1% annual chance or greater flood.

ZONE AR1 Area to be protected from 1% annual chance flood by a Federal flood protection system under construction; no Base Flood Elevation determined.

ZONE V Coastal flood zone with velocity hazard (wave action); no Base Flood Elevation determined.

ZONE VE Coastal flood zone with velocity hazard (wave action); Base Flood Elevation determined.

FLOODWAY AREAS IN ZONE AE

The floodway is the channel of a stream plus any adjacent floodplain areas that must be kept free of encroachment so that the 1% annual chance flood can be carried without substantial increase in flood heights.

OTHER FLOOD AREAS

ZONE X Areas of 0.2% annual of base flood; areas of 1% annual chance flood with average depths of less than 1 foot or with drainage areas less than 1 square mile, and areas protected by levees from 1% annual chance flood.

OTHER AREAS

ZONE X Areas determined to be within the 0.2% annual chance floodplain.

ZONE D Areas in which flood hazards are undetermined, but possible.

COASTAL BARRIER RESOURCES SYSTEM (CBRS) AREAS

OTHERWISE PROTECTED AREAS (OPAs)

Dikes, levees and coastal barriers are located within or adjacent to Special Flood Hazard Areas.

1% annual chance floodplain boundary
0.2% annual chance floodplain boundary
Floodway boundary
Zone D boundary
CBRS and OPA boundary
Boundary enclosing Special Flood Hazard Area (Zone A and Zone AE) and boundary enclosing Special Flood Hazard Areas of different base flood elevations, flood depths or flood velocities.
Base Flood Elevation line and water elevation in feet
Base Flood Elevation water surface elevation with curve, elevation in feet

* Referenced to the North American Vertical Datum of 1988

○ Cross section line
--- Transfer line
37°37'45" 122°22'33" Geographic coordinates referenced to the North American Datum of 1983 (NAD 83), Western Hemisphere
1000-meter Universal Transverse Mercator grid values, zone 10N
5000-foot grid lines, California State Plane coordinate system, zone 10 (SPSZONE 0403), Lambert Conformal Conic projection
North arrow (see explanation in notes to users section of this FIRM panel)
● M1.5 River Mile

MAP SCALE 1" = 500'

150 0 150 300 FEET
150 0 150 300 METERS

NATIONAL FLOOD INSURANCE PROGRAM

PANEL 0209H

FIRM

FLOOD INSURANCE RATE MAP

SANTA CLARA COUNTY, CALIFORNIA AND INCORPORATED AREAS

PANEL 209 OF 830
(SEE MAP INDEX FOR FIRM PANEL LAYOUT)

CONTAINS

COMMUNITY	NUMBER	PANEL	SUFFIX
CUPERTINO, CITY OF	060339	0209	H
SANTA CLARA COUNTY	060337	0209	H
SANTA CLARA, CITY OF	060350	0209	H
SUNNYVALE, CITY OF	060352	0209	H

Notice to User: The Map Number shown below should be used when placing map orders. The Community Number shown above should be used on insurance applications for the subject community.

MAP NUMBER
06085C0209H

EFFECTIVE DATE
MAY 18, 2009

Federal Emergency Management Agency

This page intentionally left blank.

APPENDIX A - 11

Cupertino City Hall Alternatives Study, Structural Evaluation
(Tipping Mar, Sept 29, 2014)

Executive Summary

Five alternative options have been discussed for the future of the City Hall, with various degrees of improvement, from performing the minimum amount of architectural remodel and structural strengthening to a brand new replacement building with additional underground parking. The first three options involve the seismic strengthening of the existing structure. This report will focus primarily on those three options, evaluated under the reference standard ASCE41-13 "Seismic Evaluation and Retrofit of Existing Buildings".

The proposed strengthening scheme for Option A involves structural strengthening of the building's seismic force resisting system to satisfy a life safety performance objective and includes minimal architectural remodeling. The limited level of seismic strengthening associated with this option will require the emergency operations center (EOC) to be relocated to another location. As part of this retrofit option, we have confirmed that the strengthening recommendations contained in the "Cupertino City Hall Essential Services Facility Analysis", dated March 27, 2012, could be implemented. The only exception would be the concrete column strengthening could be less intrusively achieved with the addition of new adjacent steel columns in lieu of fiber wrap. The new steel columns would act as secondary support members in the event of seismic related damage to the existing concrete columns. Seismic improvements would also include non-structural elements such as suspended ceilings, partition walls, and glazing systems. These elements would require bracing to seismically strengthen their connections and the replacement of any non-tempered glazing.

The proposed strengthening scheme for Options B and C both involve retrofitting the existing city hall to an immediate occupancy performance objective. This performance objective would allow the EOC to be retained within the existing city hall building. Option B would involve less architectural remodeling, whereas Option C would entail a complete architectural remodel. Option C would allow for a new, large light court in the center of the building, thus requiring additional structural modifications to both the roof and floor level gravity framing systems. Seismically, the structural deficiencies for both of these options are the same as those for Option A above. All options require strengthening the existing roof diaphragm, roof girder collector splice connections, roof girder to shear wall connections, adding additional length of concrete shear wall from the first floor level to the roof, strengthening the exterior colonnade connection to the roof framing, and strengthening the existing concrete columns to withstand anticipated seismic displacements.

Options B and C will require a more extensive strengthening of these elements than Option A, given the more stringent performance objective. As with Option A, non-structural elements will also require strengthening. To achieve immediate occupancy, these elements would have to be designed to have only minimal, limited damage after a seismic event. This may be difficult to achieve with the existing building materials to be retained in Option B. In Option C, these elements will be constructed anew, and can be explicitly designed for an immediate occupancy performance objective. Finally, it should be noted that any retrofit intended to achieve an immediate occupancy performance objective will be met using prescriptive code methods that merely increased the force level demands on seismic resisting elements. This prescriptive code based approach does not necessarily assure that the performance goals of uninterrupted operation and immediate occupancy will be met.

The construction of a new City Hall building, Options D and E, will offer the opportunity to design both the building's gravity and seismic force resisting systems for the specific performance objective of immediate occupancy. Options A, B, or C, aim to strengthen the old building by limiting damage to a structure that, even after a costly retrofit is undertaken, is still largely constructed in an antiquated manner. A new City Hall can be constructed with the latest state of the art seismic force resistance technologies, such as base isolation systems or passive energy dissipation devices which will result in a facility that is more earthquake resilient than a traditionally seismically retrofitted structure. Using state of the art, site specific, seismic modeling techniques and ductile detailing practices a greater degree of certainty regarding seismic performance can be intentionally built into the structure to assure that the city's critical service functions do not become interrupted after a large seismic event.

Existing City Hall Construction

The City Hall was originally built in the late 1960's as a one-story building with a full basement. The main roof is consisted of plywood sheathing over 3" tongue and groove decking over 6 and 8 inch timber beams. The timber roof beam are then supported by either steel or concrete girders. The roof framing for the central mechanical well is consisted of plywood sheathing over 2 in timber joists supported by steel beams. The central mechanical well is surrounded by 5' tall wood framed parapet. The main roof and the parapet are covered with clay roof tiles which represent a significant portion of the current roof's self weight and seismic mass. The structure was renovated as part of the Civic Center Improvements project in the mid 1980's. During the renovation, the north side of the basement was excavated to create a concrete terrace, approximately 20 wide, parallel to the building. Portions of the original north basement walls were removed to create new storefronts. An additional 6 inches of shotcrete was added to the remaining north basement wall. The current lateral force resisting system of the structure is 6 inch concrete shear walls above grade and 12 and 18 inch concrete shear walls in the basement. Concrete slab, joists, and girders make up the ground floor framing. Interior concrete columns extend from shallow pad footing foundations to the roof level. Perimeter concrete columns are supported by the basement walls. There is also a perimeter exterior colonnade framed with concrete columns and beams.

Structural Evaluation Methodology

The materials reviewed were the 1965 Cupertino City Hall structural drawings, 1986 Cupertino City Center Improvement architectural drawings, and the Cupertino City Hall Essential Services Facility Analysis Report dated March 27, 2012.

The methodology used to evaluate the existing City Hall structure and the associated retrofit schemes were based on American Society of Civil Engineers Standard 41-13 "Seismic Evaluation and Retrofit of Existing Buildings" (ASCE 41-13). ASCE 41-13 is a nationally recognized Standard that can be used as a tool to evaluate existing buildings and develop corresponding retrofit schemes. Although the seismic evaluation and retrofit of the existing City Hall is voluntary and the application of ASCE 41-13 is not mandatory, the use of this Standard is more appropriate than design code CBC 2013 that is intended primarily for new building designs. ASCE 41-13 takes into

consideration of existing building's material properties, construction details, expected structural component and systems performance, and evaluates them against a selected Performance Objective. The main focus of this study was to evaluate Options B and C at a Performance Objective of Immediate Occupancy under a 20% probability of exceedance in 50 years seismic hazard (Basic Safety Earthquake-1E). Options B and C are classified as a Risk Category IV Essential Facility. A Linear Static Procedure was used for the evaluation and retrofit design. Soil Site Class D was assumed as a geotechnical report was not available at this time.

Seismic Evaluation and Retrofit Recommendations

Retrofit Option A

The objective of Option A is to relocate the EOC to another facility and upgrade the City Hall to a Life Safety Performance Objective under Basic Safety Earthquake-1E. Based on our findings from the existing structure's evaluations at the Immediate Occupancy Performance Objective level and a review of the performance requirements at the Life Safety level, the recommended structural retrofit would be one that is similar to the scheme proposed by AKH Structural Engineers in the "Cupertino City Hall Essential Services Facility Analysis dated March 27, 2012.

As discussed earlier in the report, the existing concrete columns are susceptible to seismic damage due to the limited amount and size of the confinement ties around the longitudinal reinforcement. The lack of confinement ties can limit the column's ductility, or ability to sway and remain undamaged during a seismic event. This limited ductility could cause the column to lose its gravity loading carrying capabilities and ability to provide continued support of the roof framing members. The existing concrete columns should be either paired with secondary steel columns to provide redundant gravity support capabilities or strengthened with fiber reinforced polymer to address this deficiency. The exterior colonnade columns can be fiber wrapped with minimal interruptions to other architectural elements. Where the wrapping activity may not be feasible, such as in areas adjacent to exterior facades, supplemental steel 6x6 columns at the perimeter and steel 8x8 columns at the interior may be placed adjacent to the existing un-wrapped columns to serve as the back-up gravity system.

To satisfy the Life Safety Performance Objective for non-structural components and systems, it is likely a seismic safety film (designed to hold shattered glass in place) will need to be applied to any existing non-safety, non-laminated annealed glass or the glazing panes themselves should be replaced. Additional tie wires for suspended ceiling grids and additional bracing and anchorage for interior partitions should be added to prevent extensive falling of ceiling tiles and wide spread collapse of partition walls during an earthquake. Mechanical systems should also be provided with a minimum level of seismic bracing, if not already in place, to prevent duct work and piping from posing a falling hazard to occupants. Finally, new or existing roof mounted equipment should be properly anchored to roof framing. This may, in some instances of heavy equipment, require additional localized strengthening of the roof framing members themselves.

Retrofit Options B and C

Evaluation of Structural Components

The main structural deficiencies for the existing City Hall are discussed below. These deficiencies are common for both Options.

- Roof diaphragm shear capacity
- Roof collector splice capacity
- Collector to shear wall connection capacity
- Shear wall flexural capacity and seismic detailing
- Concrete column ductility
- Porch colonnade to roof connection

Recommendations for Structural Strengthening

Roof Diaphragm Strengthening Measures

The existing heavy clay roof tiles make up a significant portion of the existing roof's self weight. As the building's seismic force demand is directly proportional to the self weight, it is recommended that the existing clay roof tiles be removed and replaced with a lighter roofing material. Even with the mass of the roof significantly reduced, the force demand on the roof diaphragm is near the capacity limit state for a plywood diaphragm given the shear forces associated with an immediate occupancy performance criteria.

As such, a new High Load Diaphragm will be required for the roof area outboard of the central mechanical well. New 3/4" plywood will be provided over the existing 1/2" plywood and 3x tongue and groove blocking with two rows of 10d nails @ 2 1/2" o.c. along diaphragm boundaries and continuous panel edges, 4" o.c. at other panel edges, and 12" o.c. in field. The existing diaphragm at the central mechanical well will be strengthened with 1 row of 10d nails @ 2" o.c. along diaphragm boundaries and continuous panel edges, 3" o.c. at other panel edge, and 12" o.c. in field. New 4x6 blocking will be added at continuous panel edges perpendicular to joist framing direction.

Roof Level Collector Strengthening Measures

There are several types of collector connections at the roof level, all of which require strengthening to increase their load carrying capacity. Where the existing roof diaphragm collectors are wide flange steel roof beams, they are currently spliced to each other with machine bolts. These splices will need to be strengthened with additional new splice plates and new welding as shown in on Sheet S3, Detail 2, of the attached building retrofit drawings. Where existing roof collectors occur at steel wide flange to wood girder locations, additional horizontal Simpson Holdowns or CMST straps are required to strengthen the existing steel beam to timber girder connections, as shown in Detail 1 of Sheet S3. The porch colonnade on the exterior perimeter of the building is constructed of concrete beams and columns. The anchorage connections between these

beams/columns and the wood roof framing and diaphragm currently lacks a clear load path and does not have adequate capacity. New connecting members should be installed to provide proper anchorage between the colonnade and the roof diaphragm, as shown in Detail 4 of Sheet S3. Finally, the collector connections anchoring the steel beams to the tops of the existing concrete shear walls need to be strengthened. Additional anchor bolts will be added between existing shear walls and collectors. New shear walls will also be connected to the existing steel roof beam collectors with new anchor bolts.

Additional Concrete Shear Walls

Additional shear walls extending from foundations to roof should be added to provide new/strengthened vertical seismic force resisting elements for the existing structure. The new shear walls will typically be 12" thick concrete walls from the top of existing basement walls to the underside of the roof and 6" thick concrete walls that are overlapped and connected to the face of the existing basement walls with reinforcement dowels, as shown in Detail 3 of Sheet S3. Where the wall length is limited at the north elevation within the basement level, two new new pile caps, with two micro-piles at each cap, should be provided to increase the shear wall overturning resistance along this line and protect the existing very lightly reinforced foundation from associate seismic damage.

Strengthening the Existing Concrete Columns

The concrete columns are connected to all floor levels and to the roof. As such, they will deform as they drift with the rest of the building during an earthquake. Bending moments and shear forces will be induced in these columns as they sway with the building during a seismic event. The long span and inherent flexibility of the wood roof diaphragm will also contribute to the anticipated seismic roof drift making these under-reinforced columns very susceptible to seismic damage. The existing concrete columns have limited confinement reinforcement ties around the longitudinal reinforcements, as noted earlier in this report. Sufficient lateral ties are required in modern building codes to properly confine the longitudinal bars and the concrete core in order for the columns to continue carrying gravity loads when the columns are displaced. The lack of confinement ties is likely to result in limited displacement ductility for the concrete column. The existing columns are to be wrapped and strengthened with fiber reinforced polymer. Wrapping the existing columns will increase the displacement ductility for gravity load carrying capacity.

Structural Alterations for Option C

Additional gravity framing modifications also required for the installation of a large new light court and for the relocation of the building's elevator and stairs. Roof framing modifications such as new wood headers, blocking, and strapping are required around the new roof opening. Modifications to existing ground floor concrete framing will also be required to accommodate the new light court and various relocated stairs and elevators. These modification will include new concrete beams to support existing concrete joist framing that have had their existing support framing removed or modified. Retrofit support of gravity framing members often requires precision chipping of existing concrete surfaces, rebar coupling for reinforcement extensions, and welding of anchorage plates to properly anchor the ends of existing concrete members to new concrete supports.

Non-Structural Components and Systems for Options B and C

Existing anchorage and support details for the majority of the architectural, mechanical, electrical, and plumbing components are unknown. Additional as-built documents or site survey may be required to assess the building's non-structural components and systems conformance to the Performance Objective. The Nonstructural Performance Level for an Essential Facility should satisfy the ASCE 41-13 "Operational" Objective, where the nonstructural components and systems are able to perform the same functions they provided before the earthquake. Per ASCE 41-13, Tables C2-5 and C2-6, non-structural components, such as architectural, mechanical, electrical, and plumbing systems should have only negligible damage after a seismic event. There should be no loss of function to exterior cladding panels and they should remain weather-tight. There should not be any cracked or broken panes in the exterior glazing. There should only be negligible damage to interior partitions and ceilings with no impact on occupancy and functionality. Elevators will remain in operation. HVAC equipments, electrical distribution, and plumbing system remain operational if emergency power and other utilities are provided. Fire alarm systems and emergency lighting should remain operational. Ducts, fire suppression piping, and light fixtures should have only negligible damage.

It is likely the exterior cladding and glazing system needs to be replaced with a new system that can satisfy the Essential Facility performance objective. Anchorage and bracing for the existing suspended ceiling and interior partitions will also need to be strengthened and upgraded. Similarly, the same will apply to all of the existing mechanical, electrical, plumbing, and emergency systems if they remain. It may difficult to meet the operational performance objective for Option B where the existing building systems were not intentionally designed to remain in operation with only negligible damage after a major seismic event. Option C would allow these systems to be explicitly designed to satisfy the operational performance objective. Finally, new or existing roof mounted equipment should be properly anchored to roof framing. For moderate to heavy pieces of equipment, additional localized strengthening of the roof framing members should be anticipated.

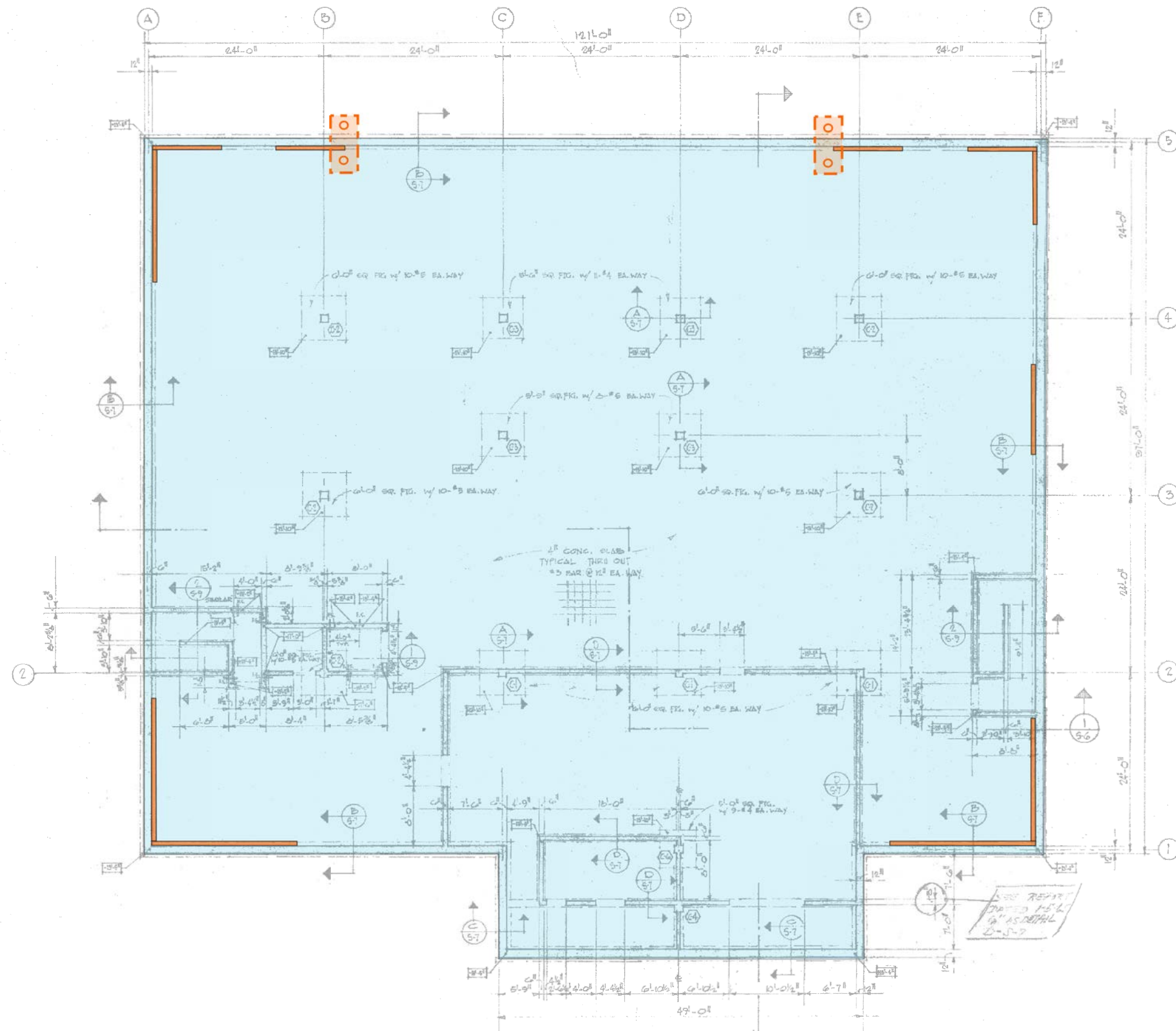

Legend:

- (N) Concrete Wall
 - (N) Pile Cap with Micropiles
- Provide 4' wide x 6' long x 4' deep pile cap with 2 micropiles at each cap.
Micropile capacity +/- 150 kip design load.

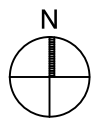

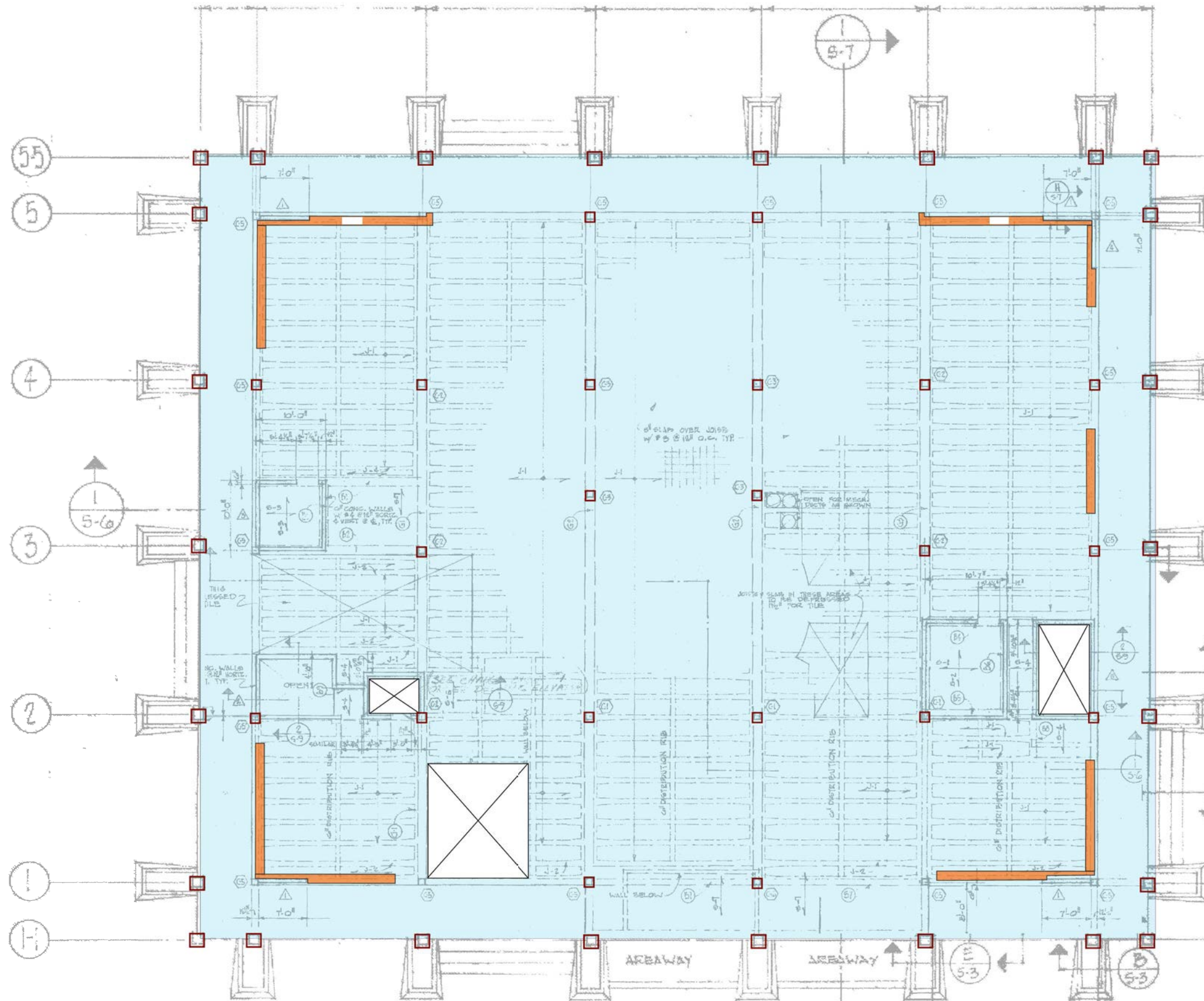

Legend:

- (N) Concrete Wall
- (N) FRP Wrap @ (E) Columns

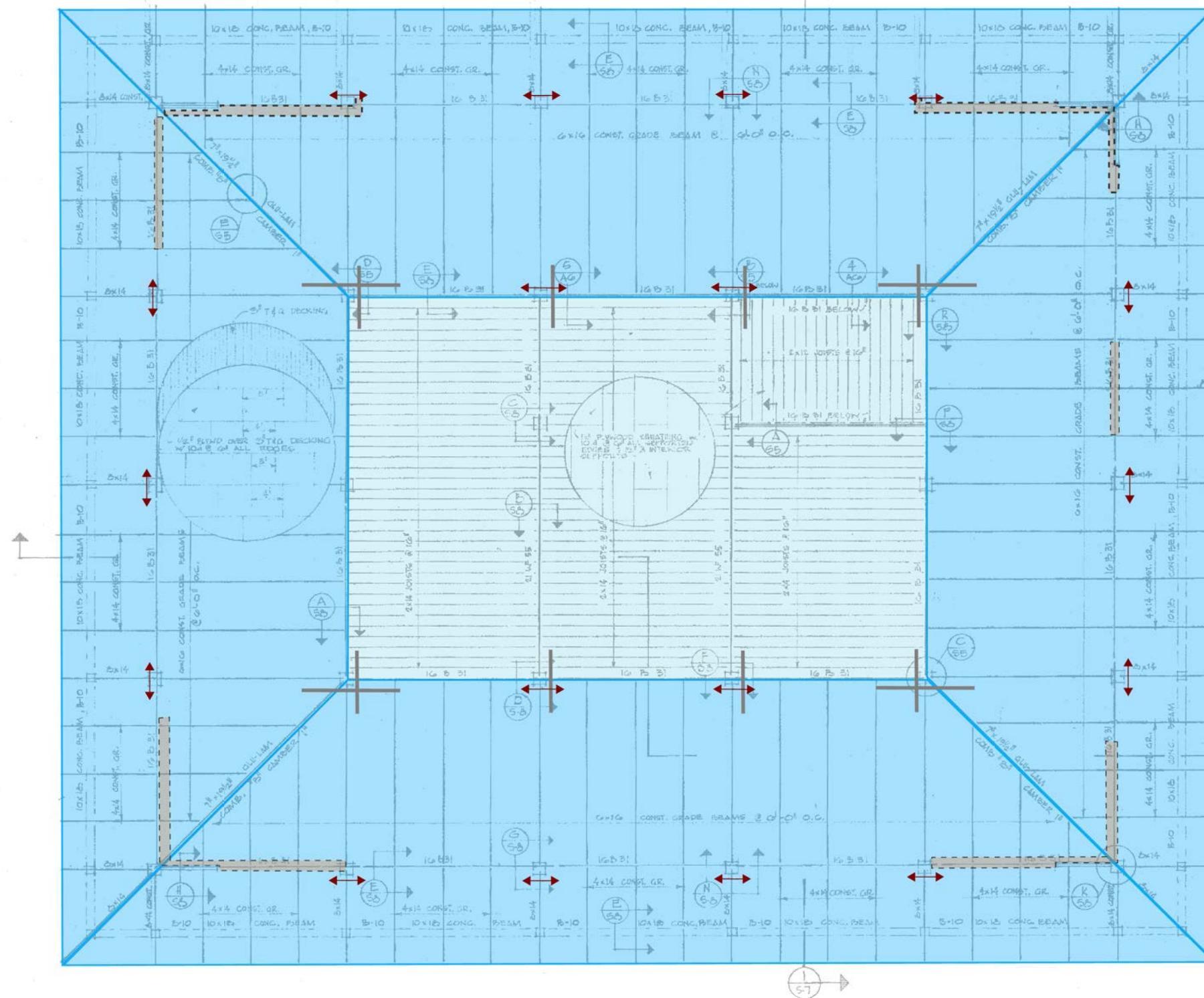

Legend:

 (N) Concrete Wall Below

 (N) High Load Diaphragm

Provide (N) 3/4" Plywood over (E) 1/2" Plywood and 3X T&G Blocking w/ 2 Rows of 10d Nails @ 2 1/2" o.c. along diaphragm boundaries and cont. panel edges, 4" o.c. at other panel edges, and 12" o.c. in field

 (E) Reinforced Diaphragm

Reinforce (E) 1/2" Plywood w/ 1 Row of 10d Nails @ 2" o.c. along diaphragm boundaries and cont. panel edges, 3" o.c. at other panel edges, and 12" o.c. in field. Provide (N) 4x6 min. blocking @ cont. panel edges perpendicular to framing direction, typ.

 (N) Simpson CMST strap or Simpson Holddown

 Retrofitted WF Steel Collector Connection

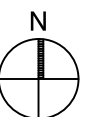

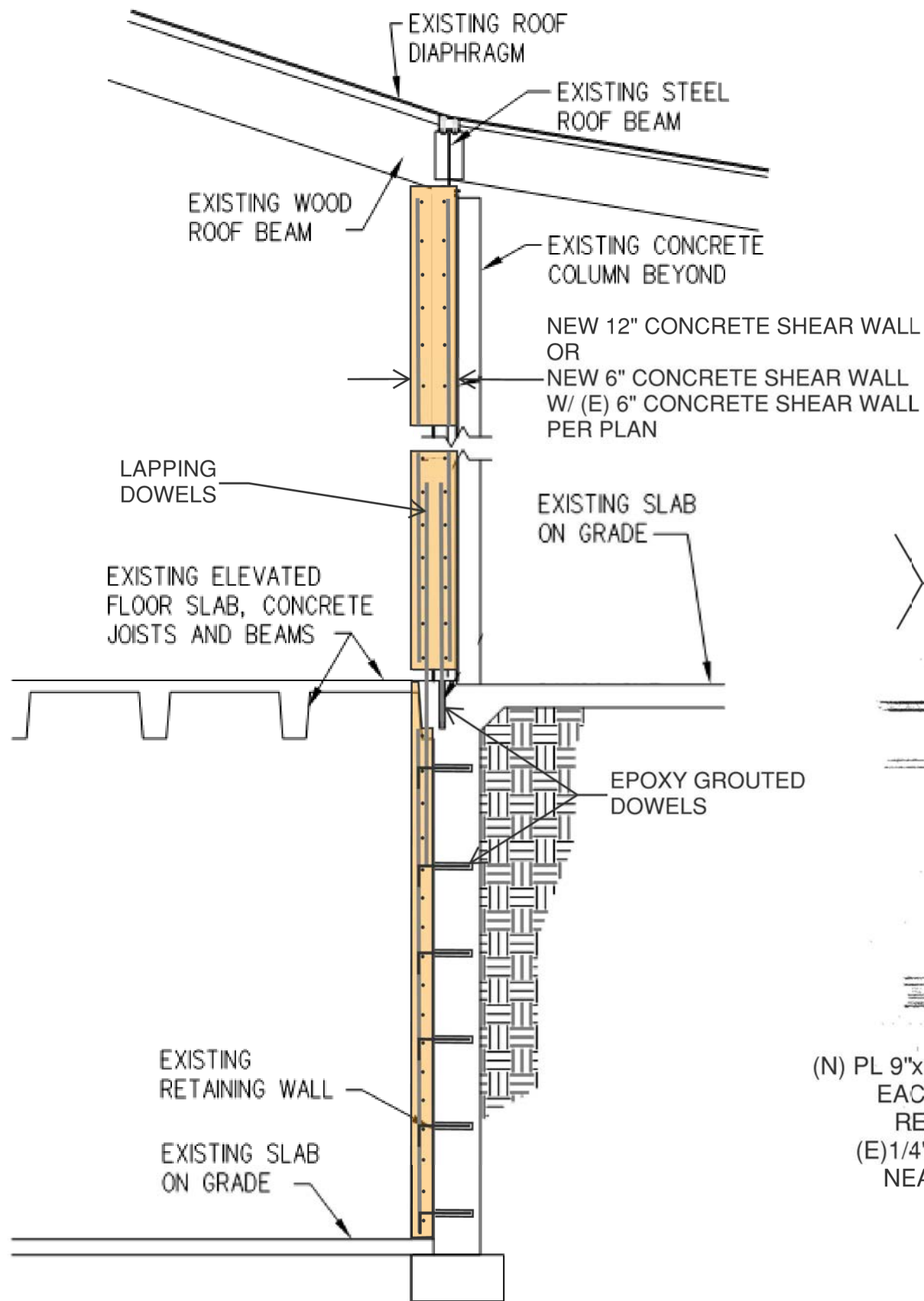

DETAIL 3 - SECTION AT NEW CONCRETE SHEAR WALL

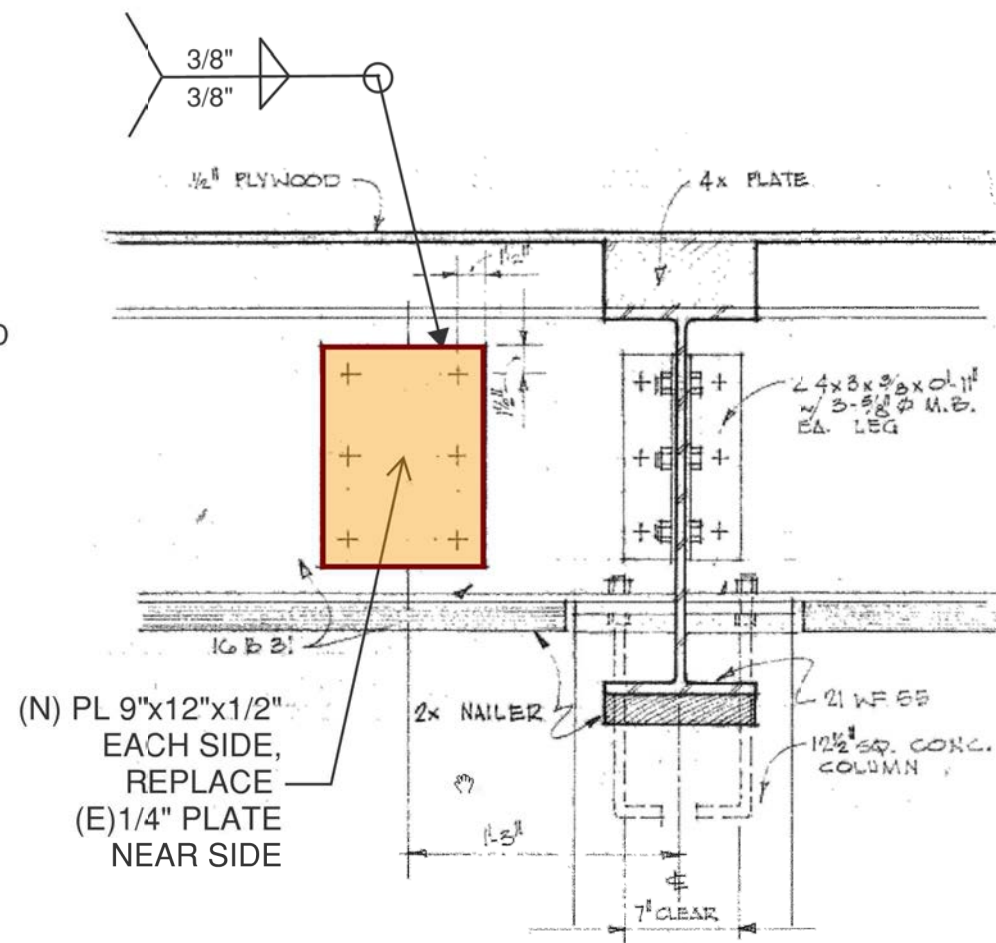

DETAIL 2 - STEEL TO STEEL COLLECTOR SPLICE

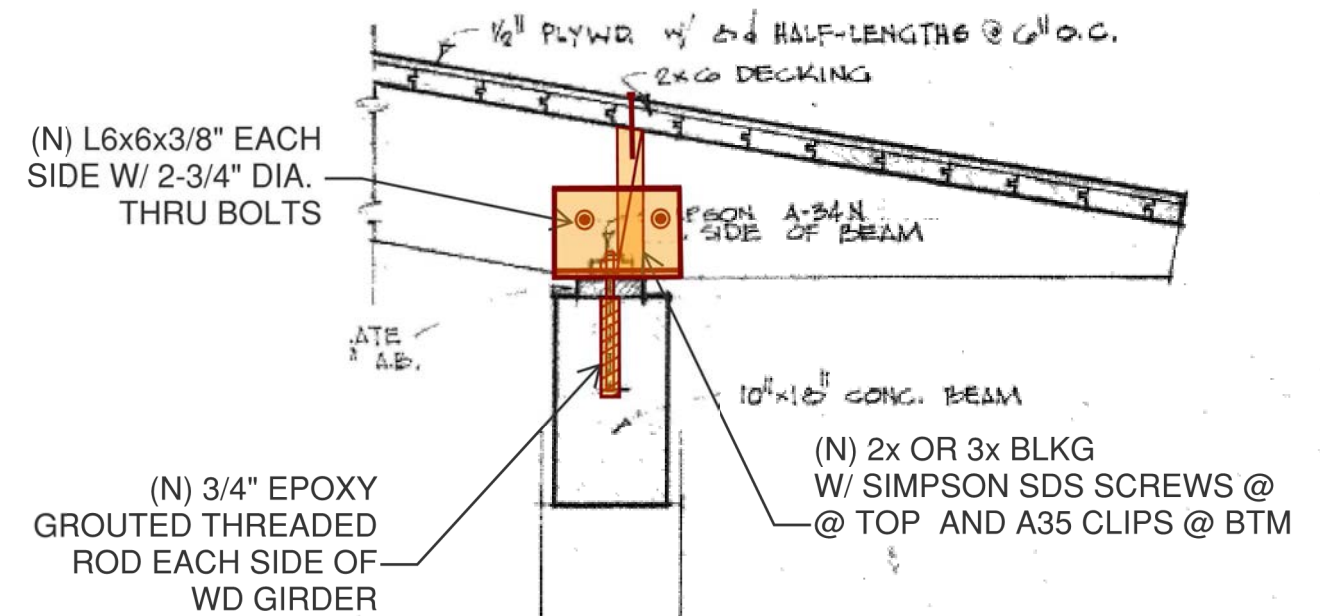

DETAIL 4 - COLONNADE TO ROOF ANCHORAGE

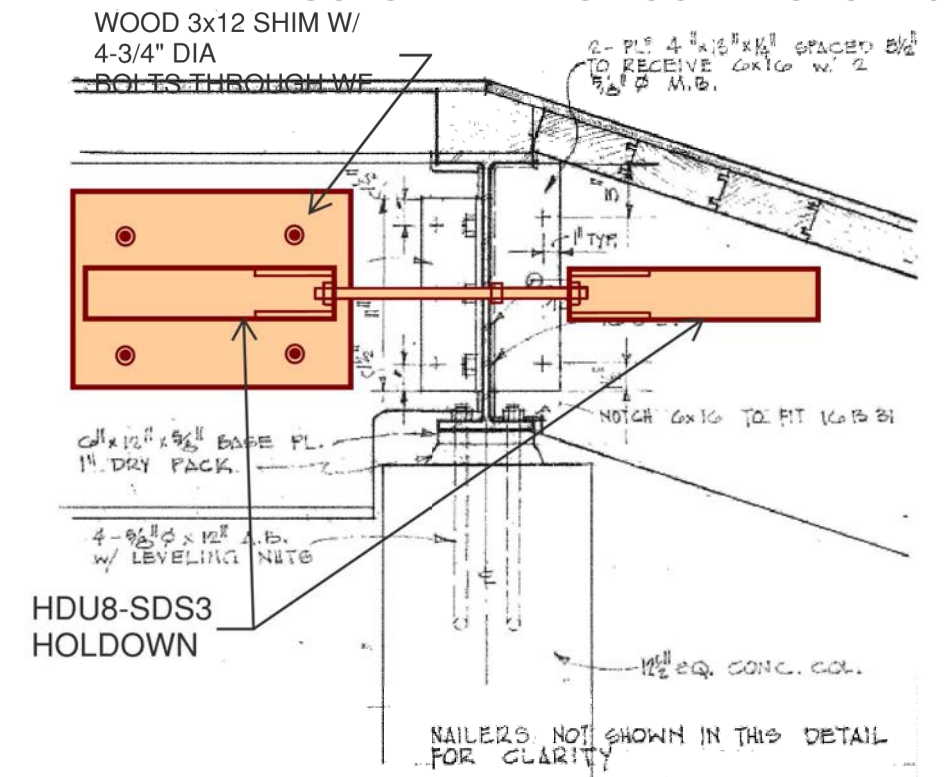

DETAIL 1 - STEEL TO WOOD COLLECTOR CONN.

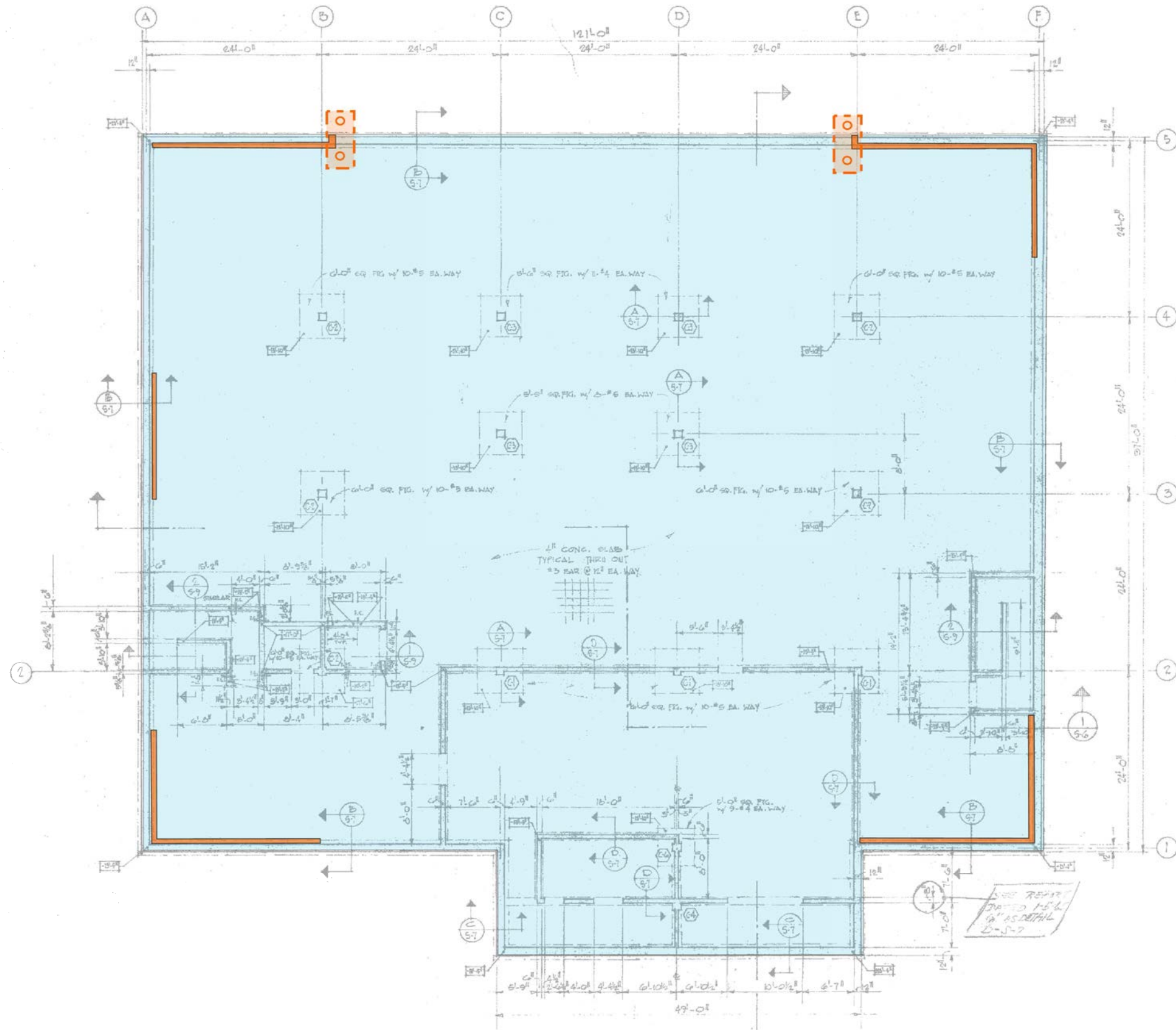

Legend:

- (N) Concrete Wall
- (N) Pile Cap with Micropiles
 Provide 4' wide x 6' long x 4' deep pile cap with 2 micropiles at each cap. Micropile capacity +/- 150 kip design load.

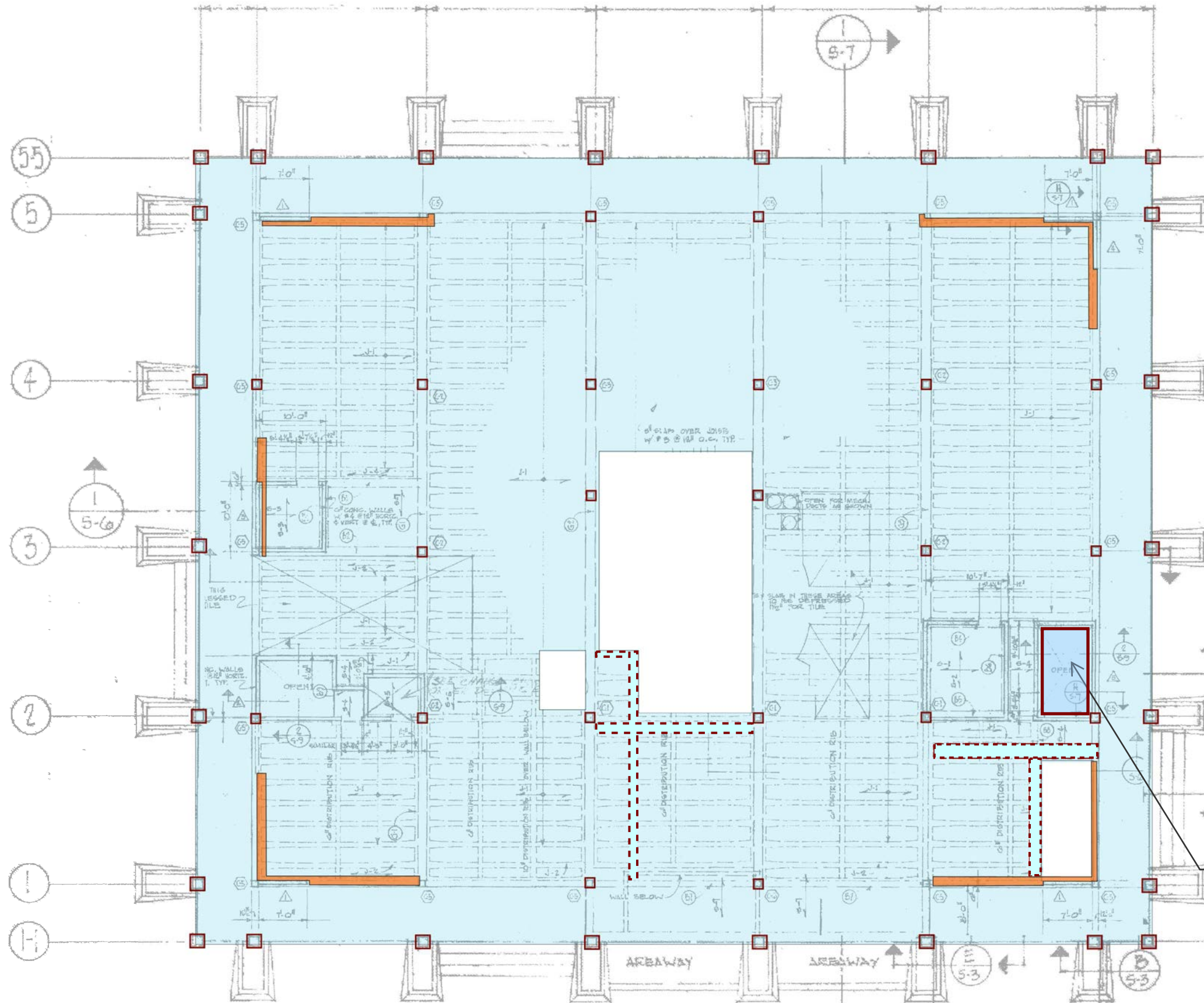



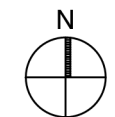

- Legend:**
- (N) Concrete Wall
 - (N) FRP Wrap @ (E) Columns
 - (N) Concrete Beam Below

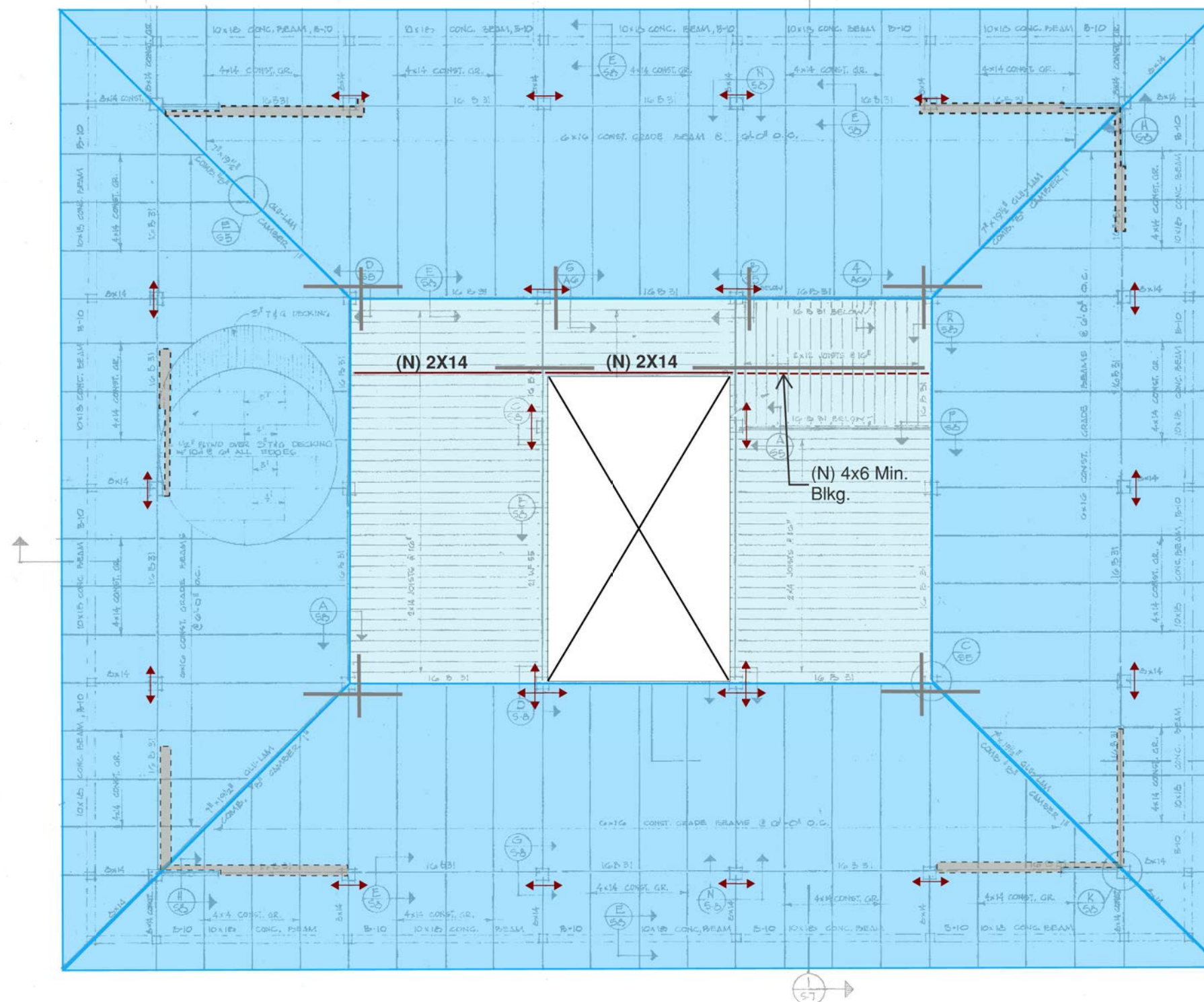
INFILL (E) OPENING W/
PERIMETER L6x4x5/16
ANGLES AND (N) CONC.
ON METAL DECK





- Legend:**
-  (N) Concrete Wall Below
 -  (N) High Load Diaphragm
Provide (N) 3/4" Plywood over (E) 1/2" Plywood and 3X T&G Blocking w/ 2 Rows of 10d Nails @ 2 1/2" o.c. along diaphragm boundaries and cont. panel edges, 4" o.c. at other panel edges, and 12" o.c. in field
 -  (E) Reinforced Diaphragm
Reinforce (E) 1/2" Plywood w/ 1 Row of 10d Nails @ 2" o.c. along diaphragm boundaries and cont. panel edges, 3" o.c. at other panel edges, and 12" o.c. in field. Provide (N) 4x6 min. blocking @ cont. panel edges perpendicular to framing direction, typ.
 -  (N) Simpson CMST strap or Simpson Holddown
 -  Retrofitted WF Steel Collector Connection

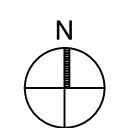

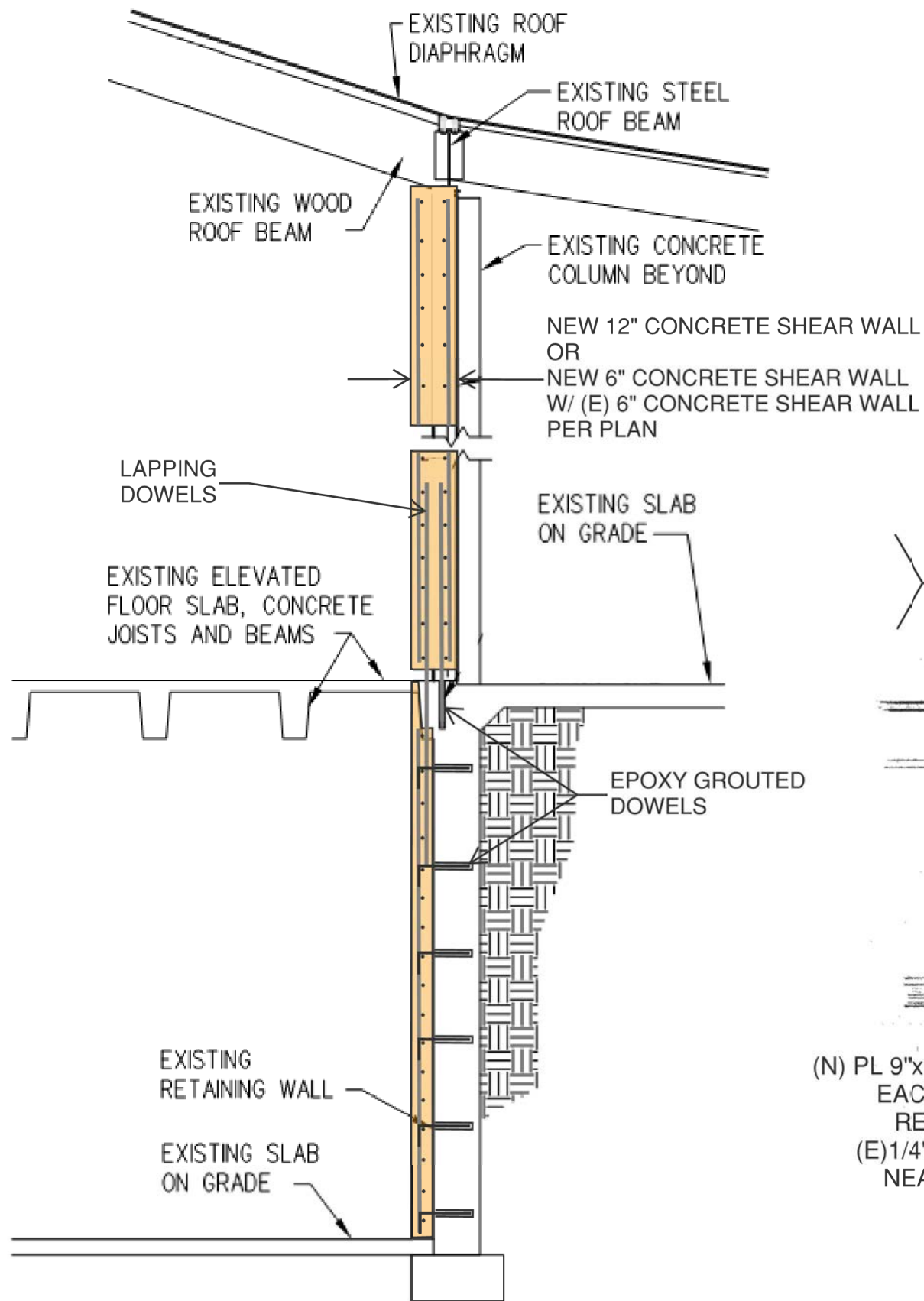

DETAIL 3 - SECTION AT NEW CONCRETE SHEAR WALL

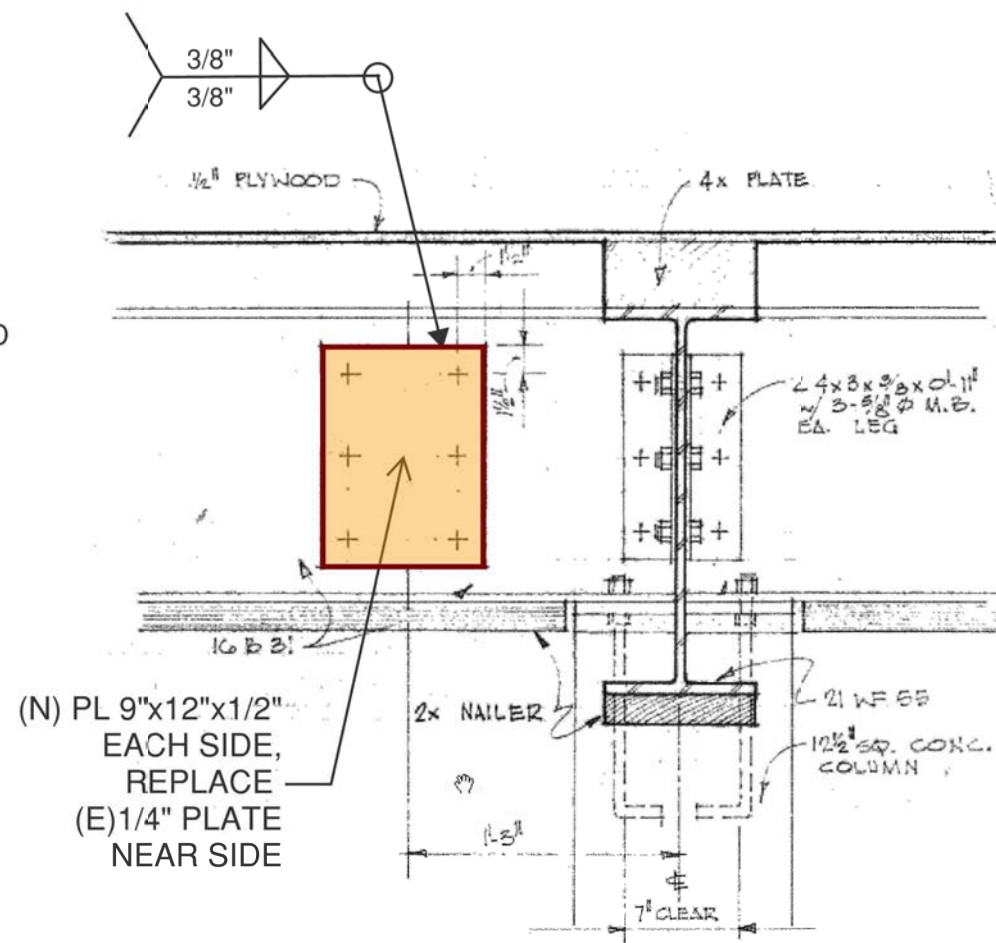

DETAIL 2 - STEEL TO STEEL COLLECTOR SPLICE

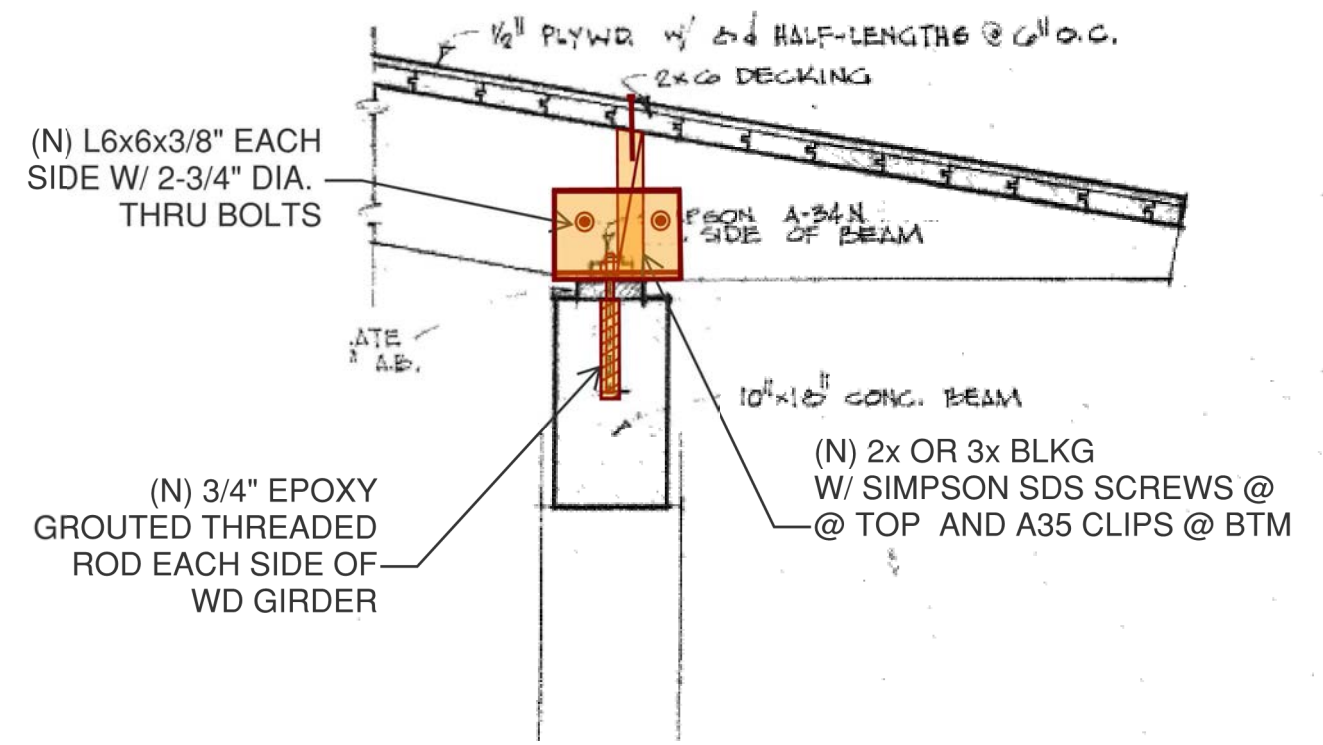

DETAIL 4 - COLONNADE TO ROOF ANCHORAGE

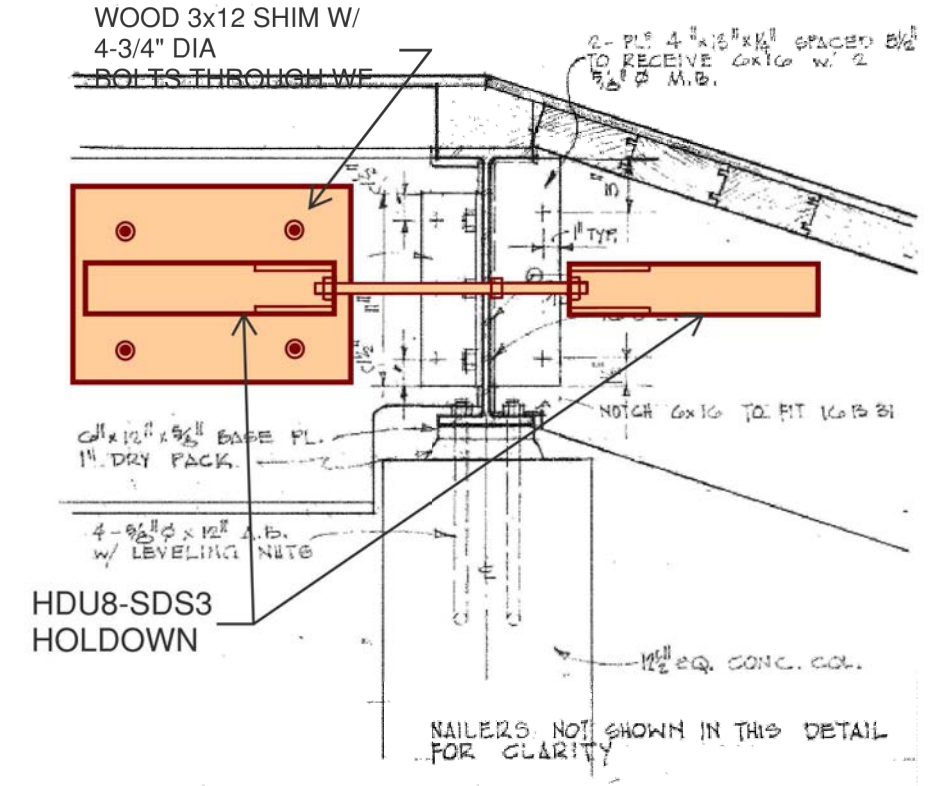

DETAIL 1 - STEEL TO WOOD COLLECTOR CONN.

This page intentionally left blank.

APPENDIX A - 12

City Hall Alternatives Study (P+W, Sept 16, 2014)

This page intentionally left blank.

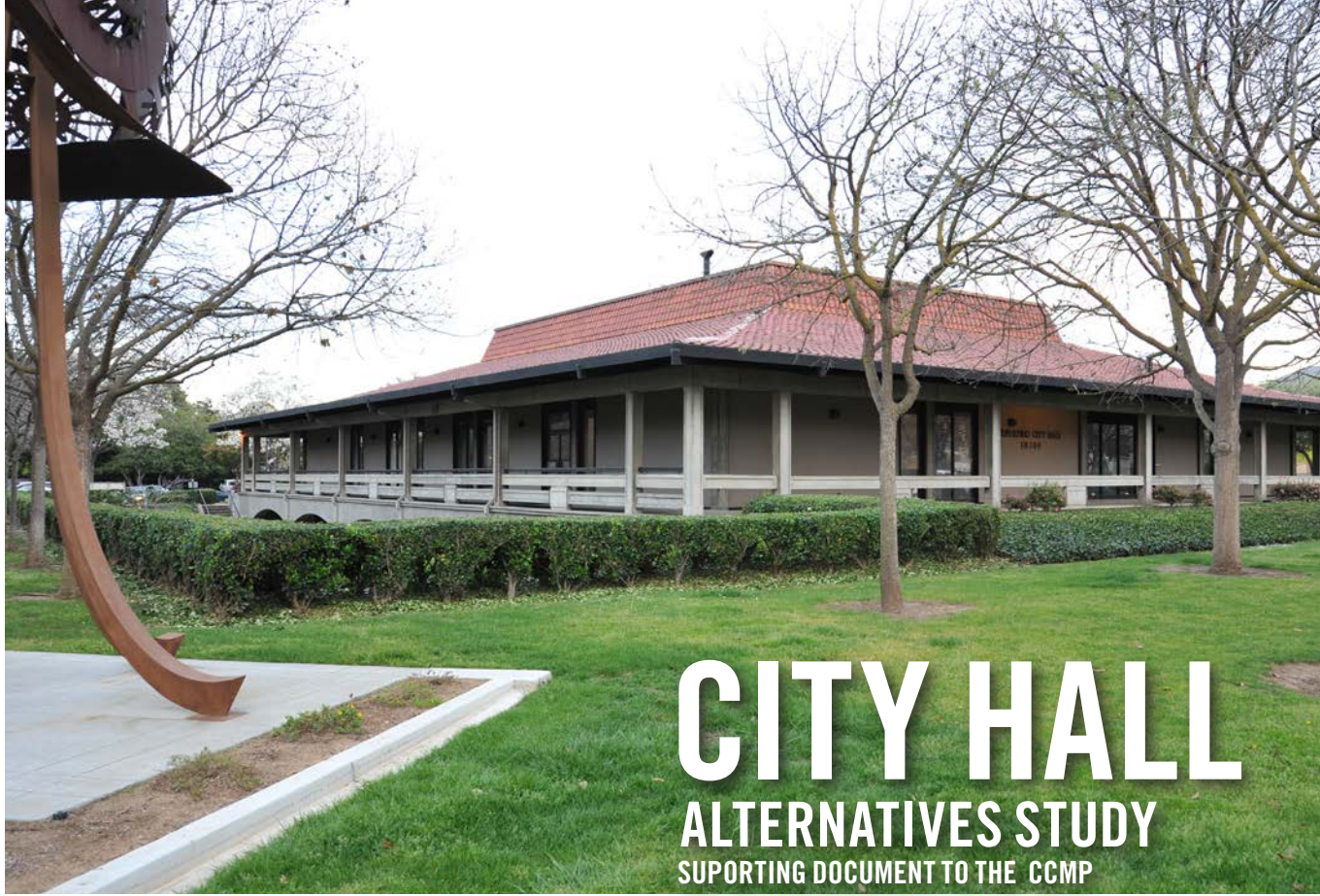

CITY HALL

ALTERNATIVES STUDY

SUPPORTING DOCUMENT TO THE CCMP



CITY OF CUPERTINO
SEPT 16, 2014

PERKINS
+ WILL

AGENDA

September 16, 2014

**BRING CLARITY TO THE 5 CITY HALL SCENARIOS &
MULTIPLE CCMP SUB-SCENARIOS (30 min)**

**DISCUSS/ FEEDBACK SPECIFICALLY ON OPTION C
(GUT AND REMODEL) (30 min)**

NEXT STEPS

5 OPTIONS FOR CITY HALL

- A. UPGRADE CITY HALL WITH LIFE SAFETY
- B. UPGRADE CITY HALL WITH LIFE SAFETY + EOC
- C. GUT AND REMODEL CITY HALL

- D. NEW CITY HALL BUILDING + *BASEMENT PARKING*
- E. NEW CITY HALL BUILDING + COUNCIL CHAMBERS + *BASEMENT PARKING*

CITY HALL ALTERNATIVES.

LIB. PROGRAM
STUDY ROOM, ETC.

TEEN CENTER
OR COMMUNITY CENTER

PARKING

COST

EXISTING BUILDING

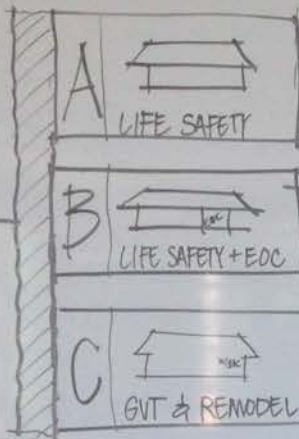

USE LIBRARY BUILDING

L1. EXPAND EAST OR WEST WING

T1. EXPAND LIB. WING

T2. STAND-ALONE BUILDING.

P1. LIBRARY FIELD

P2. BEHIND LIBRARY

P1. LIBRARY FIELD

P2. BEHIND LIBRARY

\$

\$

\$

\$

\$

\$

\$

\$

USE LIBRARY BUILDING

L1. EXPAND EAST OR WEST WING

T1. "

T2. "

P1. "

P2. *

P1. *

P2. *

USE LIBRARY BUILDING

L1. EXPAND EAST OR WEST WING.

T1. "

T2. "

T3. INCLUDE WITH CH. REMODEL

P1. "

P2. "

NEW BUILDING

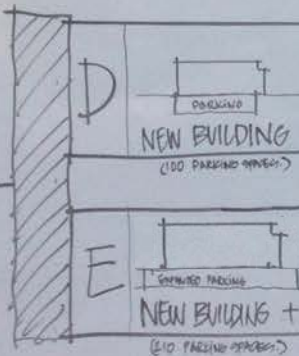

USE LIBRARY BUILDING

L1. EXPAND EAST OR WEST WING.

T1.

T2.

T3.

P1. LIBRARY FIELD

P2. BEHIND LIBRARY

P3. 100 SPACES BELOW CITY HALL

USE LIBRARY BUILDING

L1. EXPAND EAST OR WEST WING

T1.

T2.

T3.

P4. MAXIMUM PARKING UNDER CITY HALL

ADD CIVIC GARDEN.

USE COMMUNITY HALL BUILDING

L2. SHIFT LIBRARY PROGRAM TO EXISTING COMM. HALL

T1. EXPAND LIBRARY WING

T2. STAND-ALONE

T3. INCLUDE WITH CH. REMODEL

T4. INCLUDE WITH COMMUNITY HALL

CITY HALL EXISTING CONDITIONS

CITY HALL STUDY

EXISTING CITY HALL

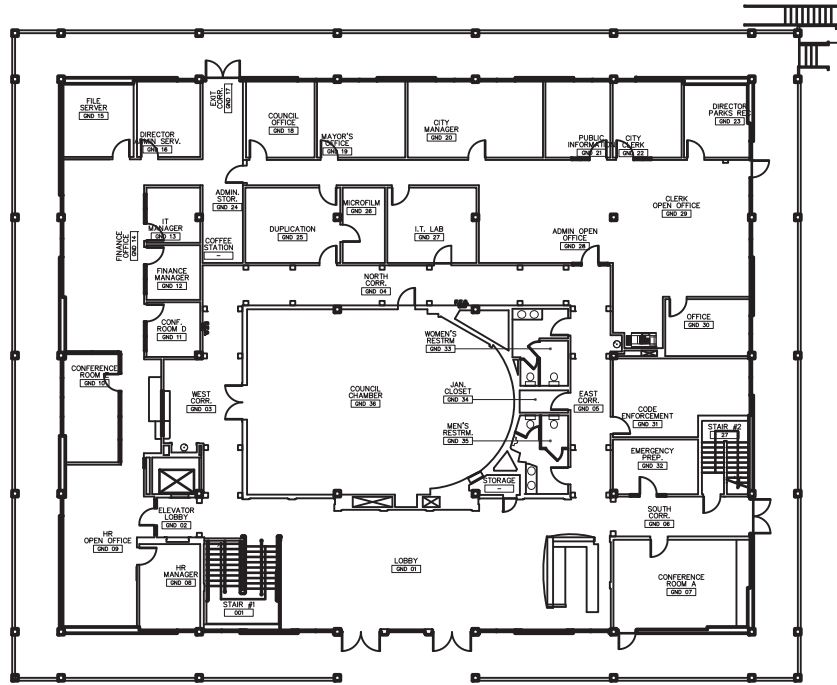

GROUND LEVEL

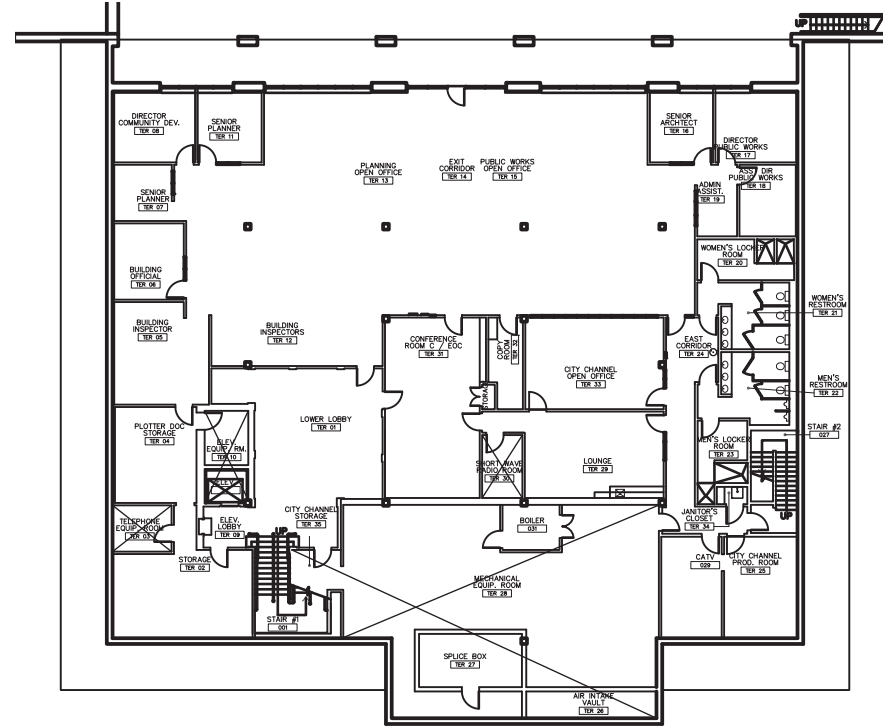

TERRACE LEVEL

CITY HALL STUDY

EXISTING DAY LIGHTING

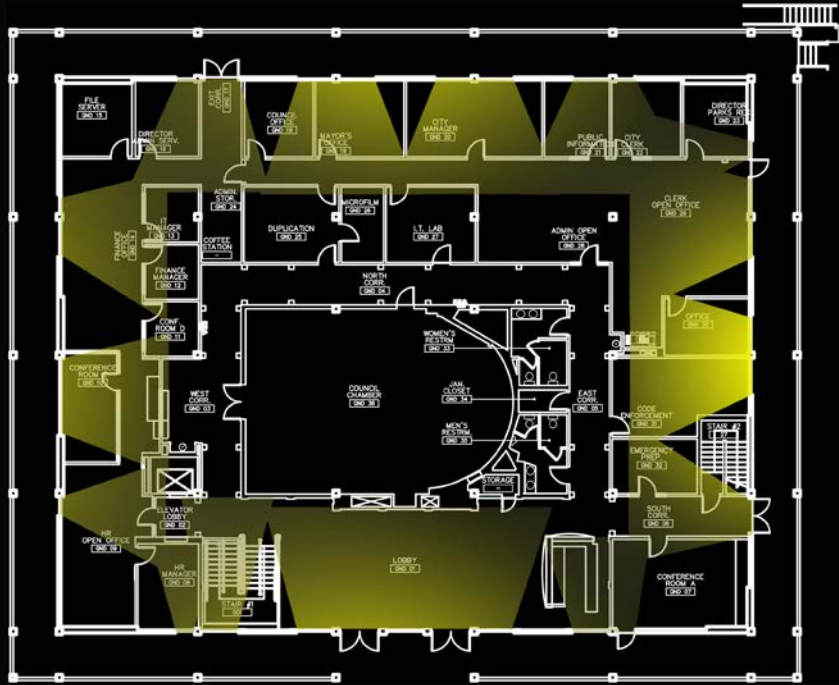

GROUND LEVEL

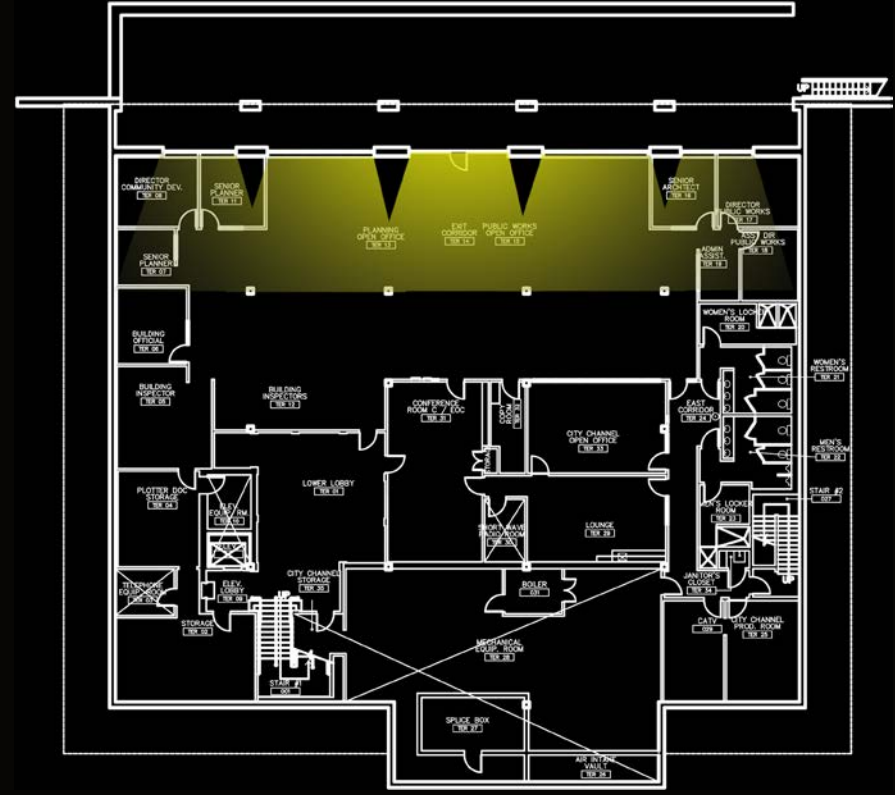

TERRACE LEVEL

CITY HALL STUDY

EXISTING CITY HALL

ISSUE: UNDER UTILIZED, OVERSIZED

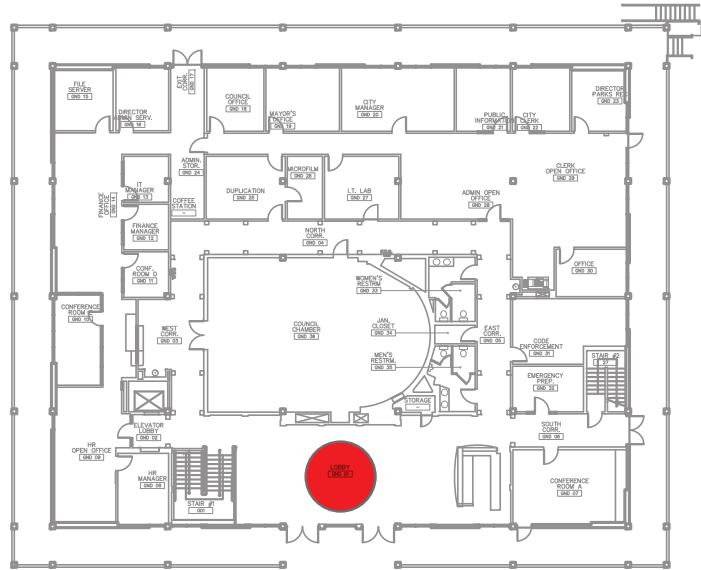

GROUND LEVEL



LOBBY

CITY HALL STUDY

EXISTING CITY HALL

ISSUE: INFLEXIBLE WORK STATIONS

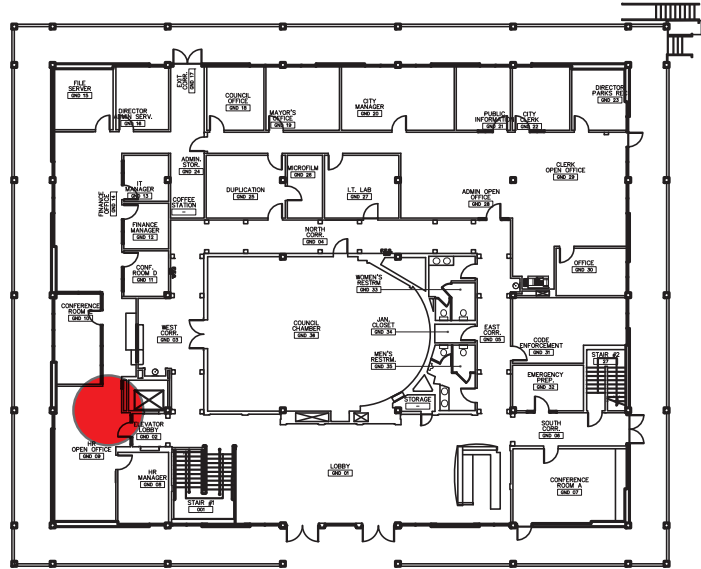

GROUND LEVEL



WORK STATIONS

CITY HALL STUDY

EXISTING CITY HALL

ISSUE: WORK STATION SIZES, FLEXIBILITY

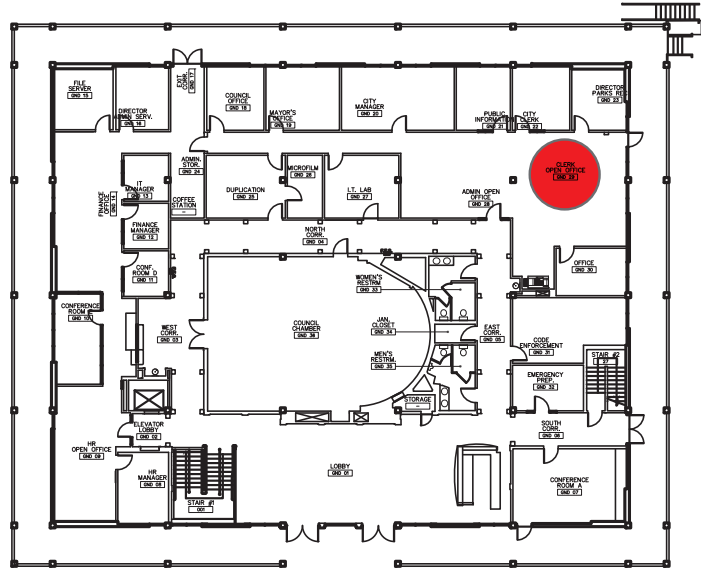

GROUND LEVEL



SHARED SPACE

CITY HALL STUDY

EXISTING CITY HALL

ISSUE: QUALITY OF MEETING SPACES

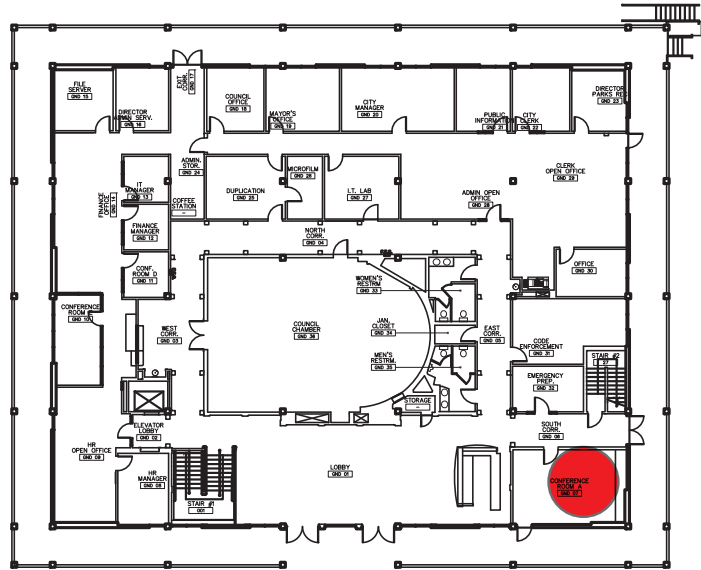

GROUND LEVEL



MEETING ROOMS

CITY HALL STUDY

EXISTING CITY HALL

ISSUE: CAPACITY/ UTILIZATION/ DAY LIGHTING

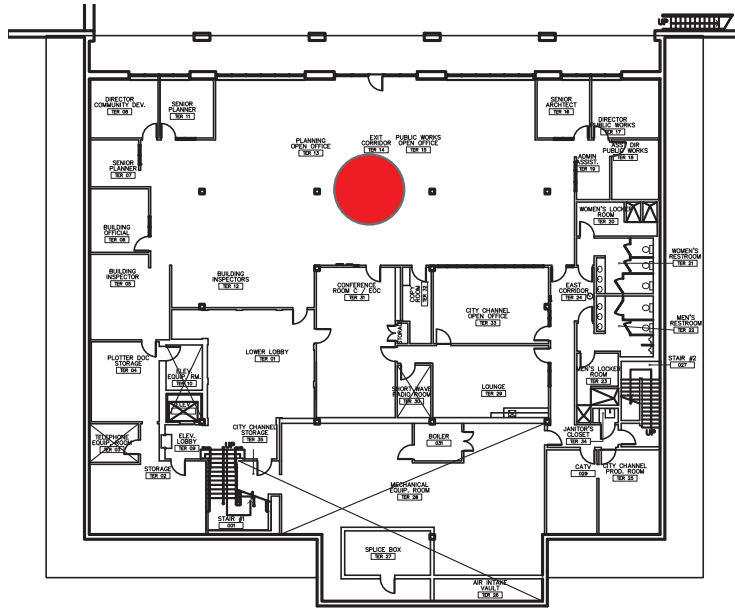

TERRACE LEVEL



OPEN OFFICE

CITY HALL STUDY

EXISTING CITY HALL

ISSUE: CAPACITY/ UTILIZATION/ DAY LIGHTING

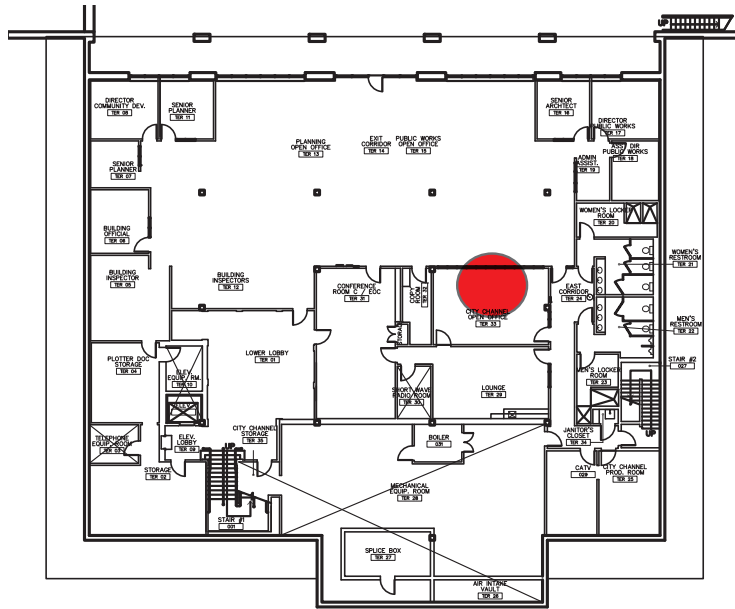

TERRACE LEVEL



IT/ MEDIA

CITY HALL STUDY

EXISTING CITY HALL

ISSUE: CAPACITY/ UTILIZATION/ DAY LIGHTING

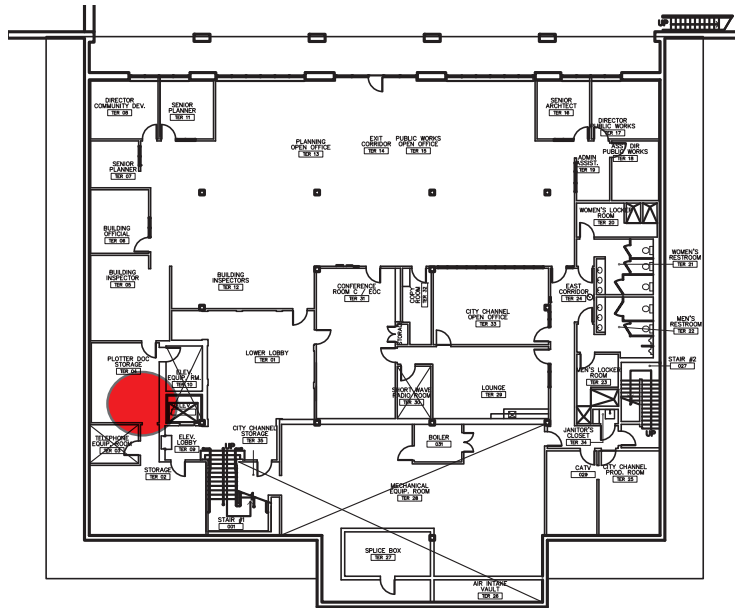

TERRACE LEVEL



PLAN CHECK AREA

ALTERNATIVE C: GUT AND REMODEL

CONCEPT 1- LIGHT WELLS

CONCEPT 2- LIGHT COURT

CITY HALL STUDY

GUIDING PRINCIPLES

CIVIC IDENTITY

PUBLIC EXPERIENCE + PROGRESSION

PROGRAM (PUBLIC AND PRIVATE)

WORKPLACE ENVIRONMENT

OVERALL SPACE UTILIZATION

DAY LIGHTING

CITY HALL STUDY
ASSUMPTIONS

BETTER SPACE UTILIZATION

WORKPLACE STATIONS CAN BE MORE EFFICIENT

RETAIN AND REINFORCED STRUCTURE

MODIFY/ REDESIGN ROOF

ALL INTERIOR WALLS ARE ALLOWED TO BE RECONFIGURED

MAINTAIN AND OPTIMIZE DAY LIGHTING FROM EXISTING WINDOWS

ALTERNATIVE C: CONCEPT 1- LIGHT WELLS

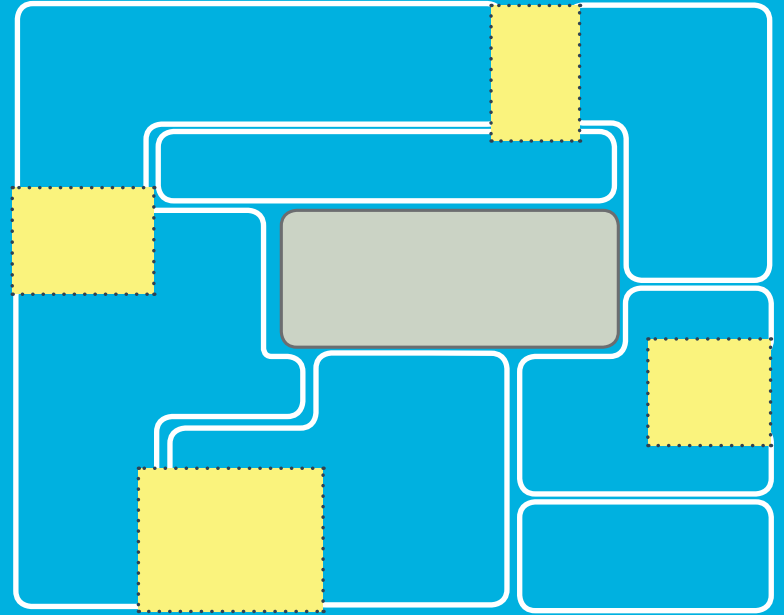

CITY HALL STUDY

CONCEPT A: LIGHT WELLS

GROUND LEVEL

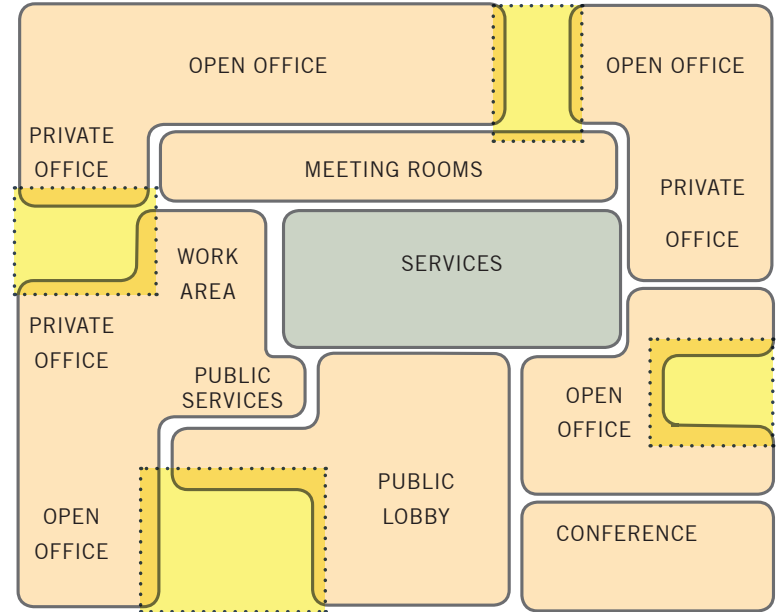

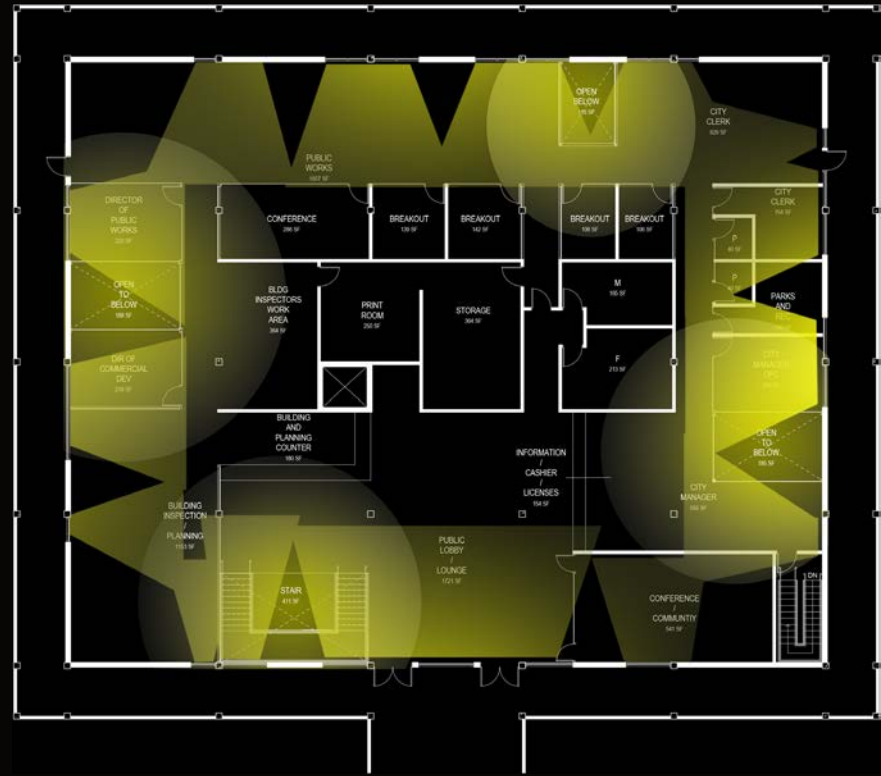

CITY HALL STUDY

CONCEPT A: SPACE PLAN

GROUND LEVEL



CITY HALL STUDY

CONCEPT A: LIGHT WELLS

TERRACE LEVEL

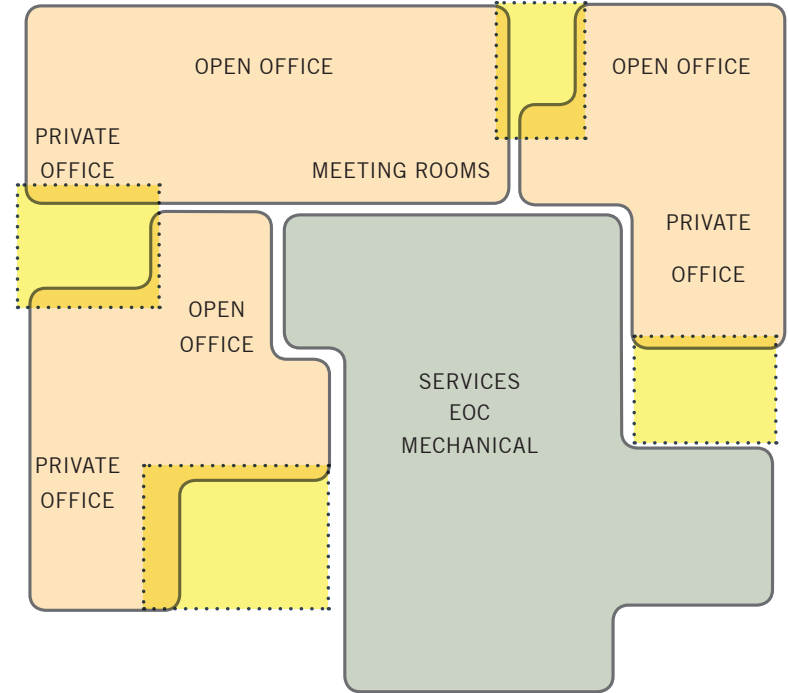

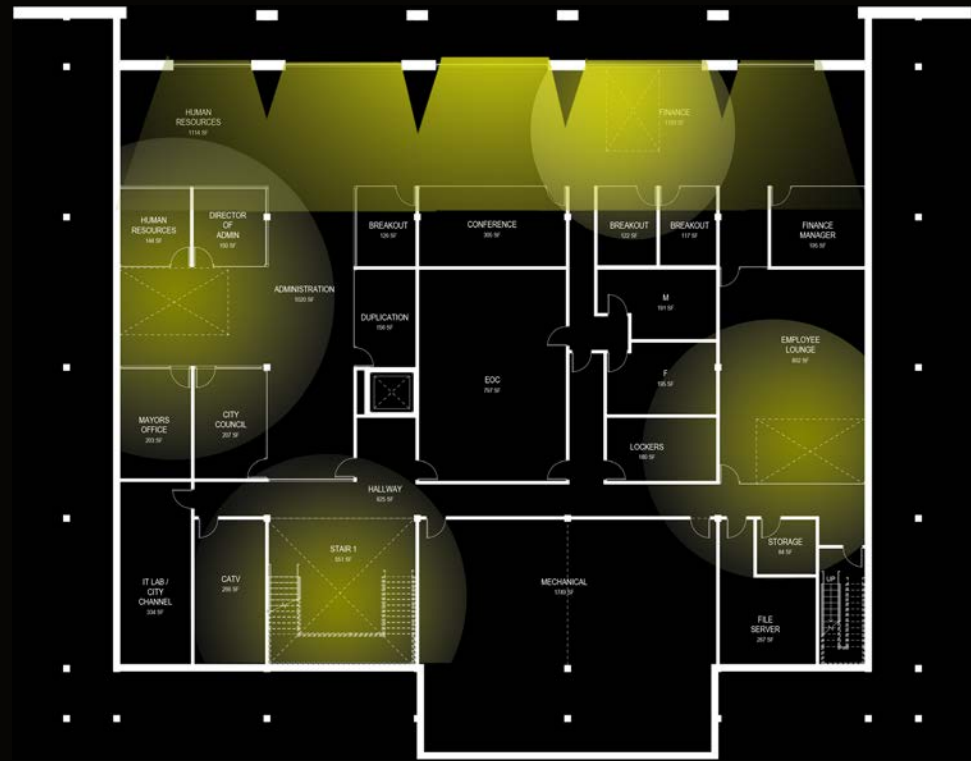

TERRACE LEVEL

CITY HALL STUDY

CONCEPT A: SPACE PLAN

TERRACE LEVEL



CITY HALL STUDY

CONCEPT A: FURNITURE PLAN

TERRACE LEVEL



ALTERNATIVE C: CONCEPT 2- LIGHT COURT

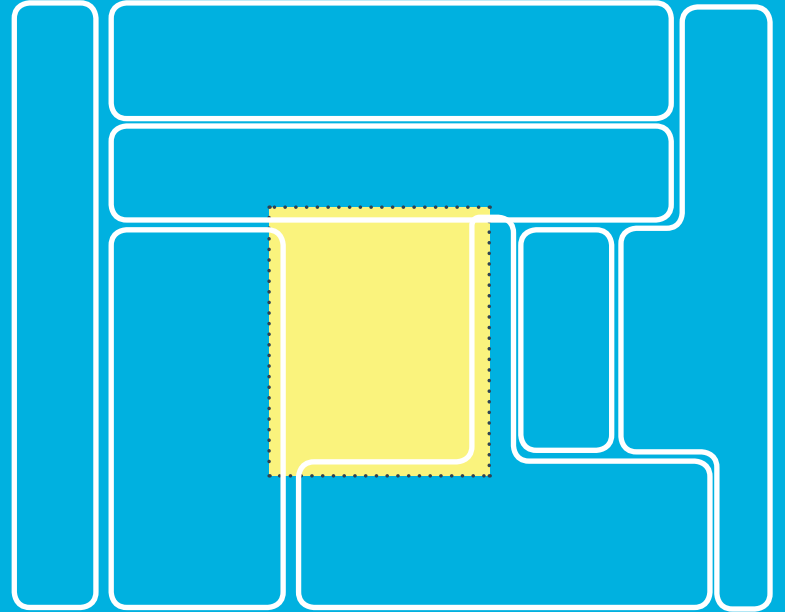

CITY HALL STUDY

CONCEPT B: LIGHT COURT

GROUND LEVEL

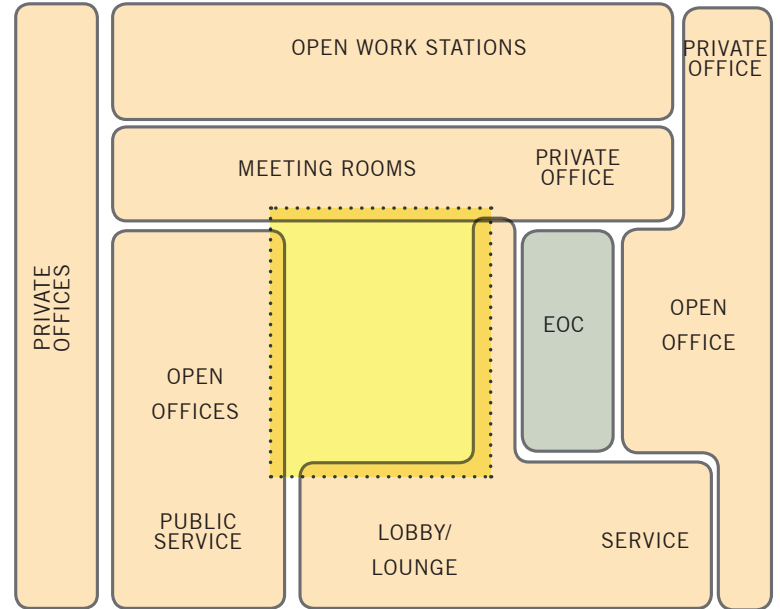

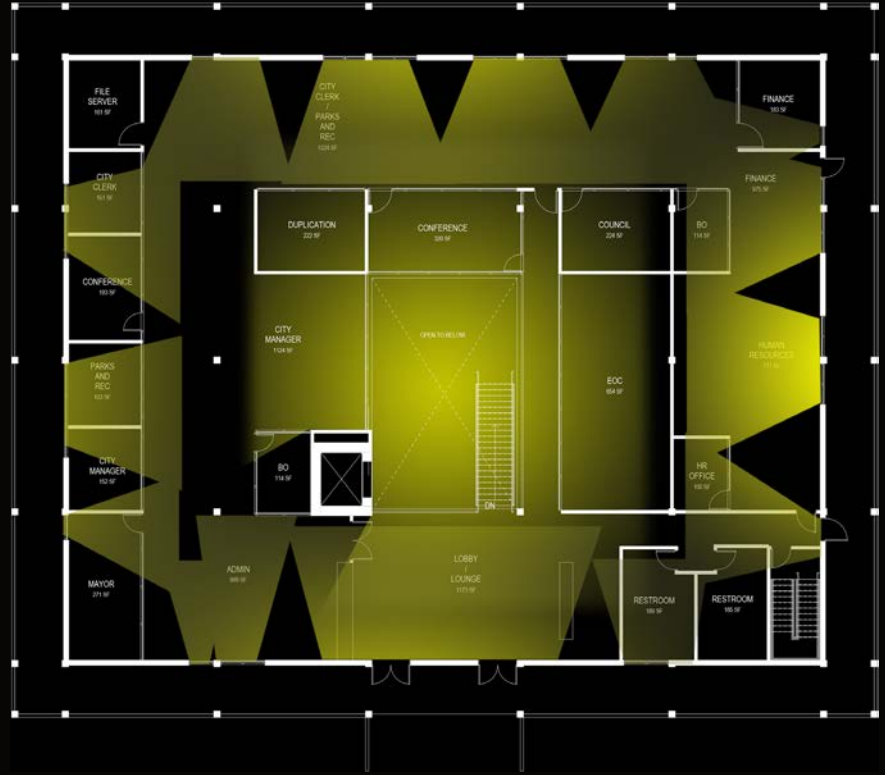

GROUND LEVEL



CITY HALL STUDY

CONCEPT B: SPACE PLAN

GROUND LEVEL



CITY HALL STUDY

CONCEPT B: LIGHT COURT

TERRACE LEVEL

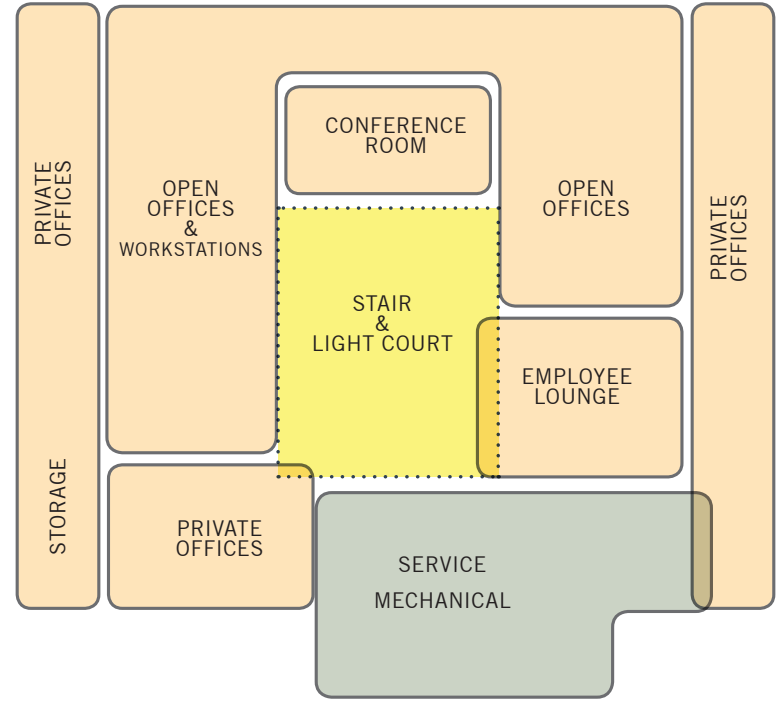

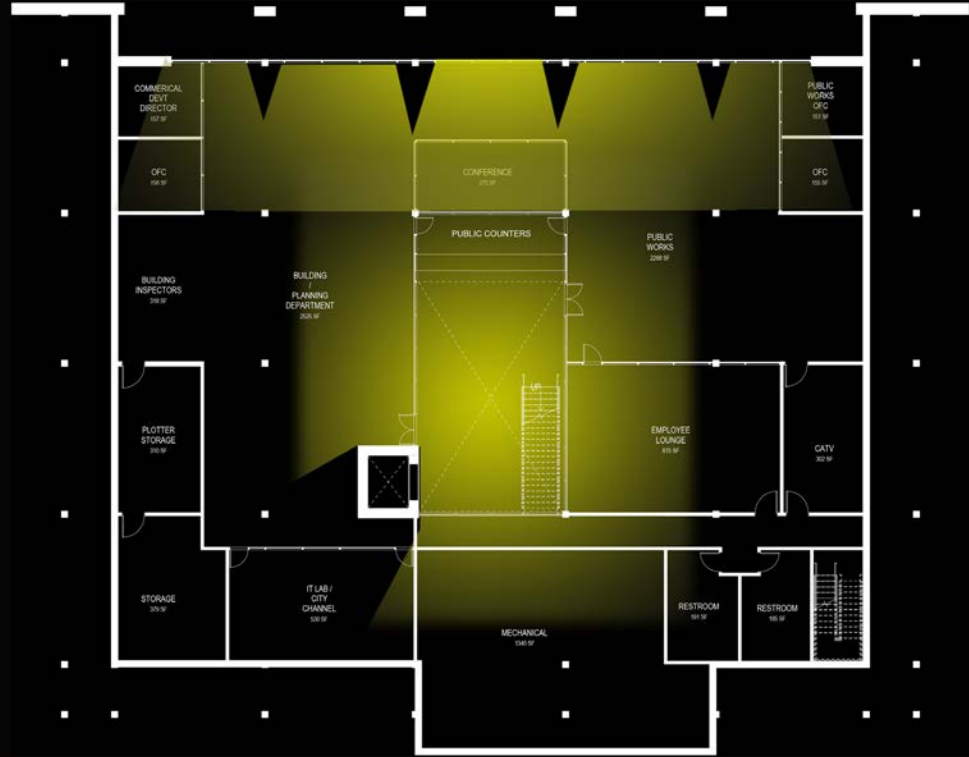

TERRACE LEVEL





Sept 16, 2014

CITY HALL STUDY

CONCEPT B: SPACE PLAN

GROUND LEVEL



CITY HALL STUDY

CONCEPT B: FURNITURE PLAN

GROUND LEVEL

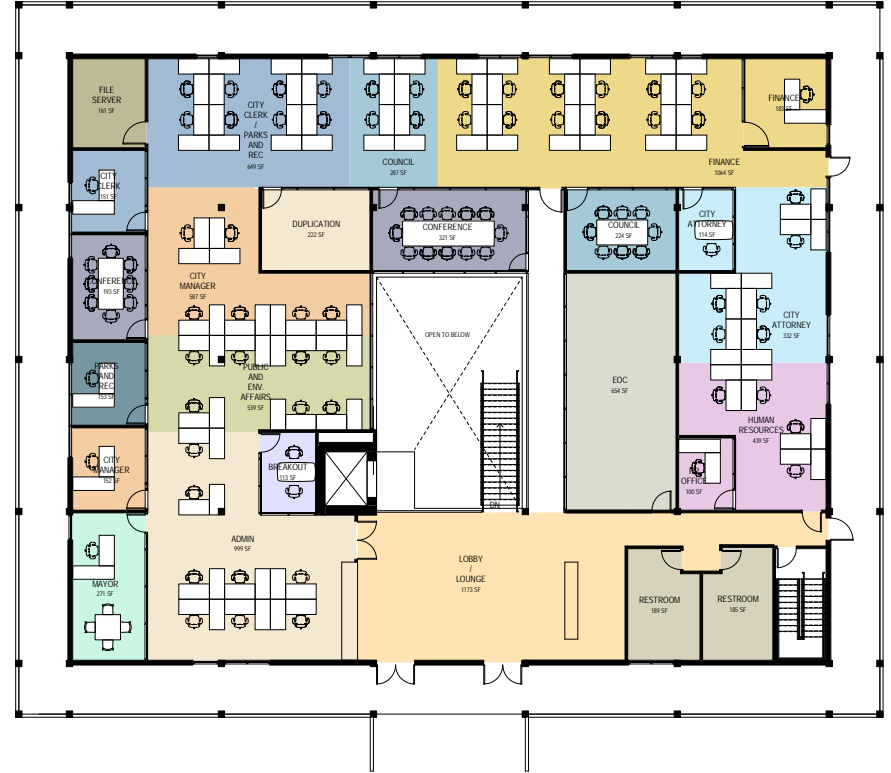

CITY HALL STUDY

CONCEPT B: FURNITURE PLAN

TERRACE LEVEL



CITY HALL INSPIRATION PRECEDENT IMAGERY

NORTH VANCOUVER CITY HALL











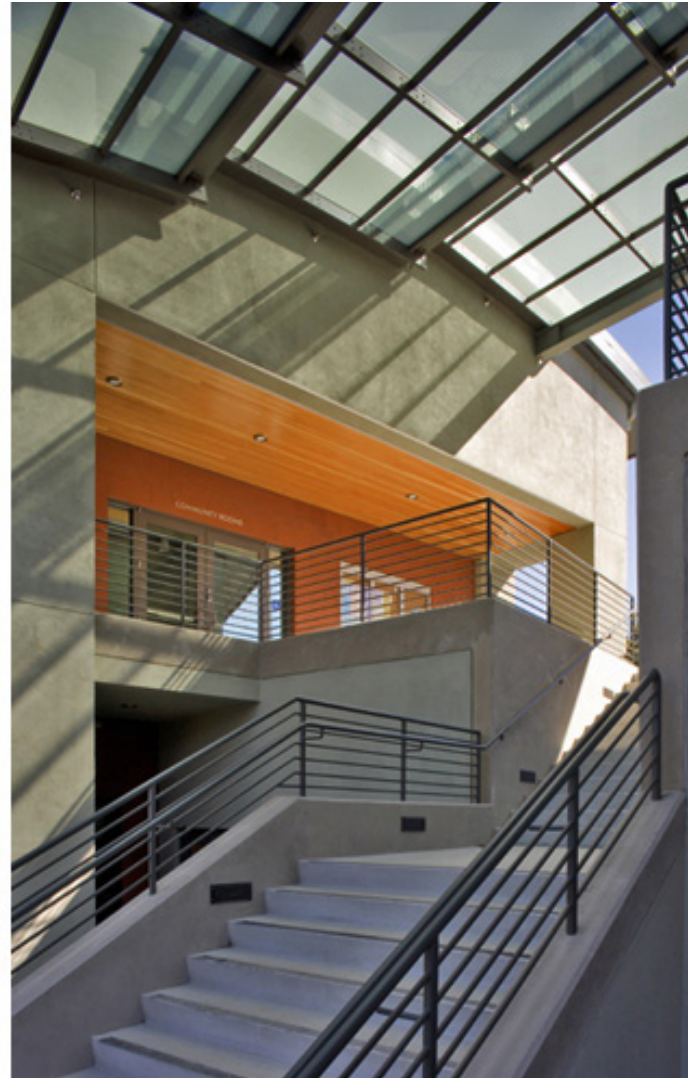





APPENDIX A - 13

ADA Self Evaluation & Transition Plan
(City of Cupertino, March, 2015)



CITY OF CUPERTINO

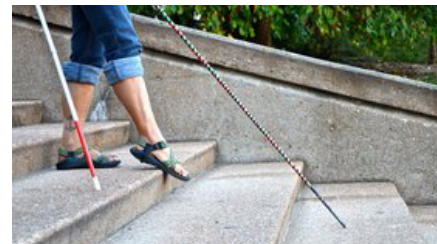

AMERICANS WITH DISABILITIES ACT

self evaluation and transition plan

APPENDICES

MARCH 2015

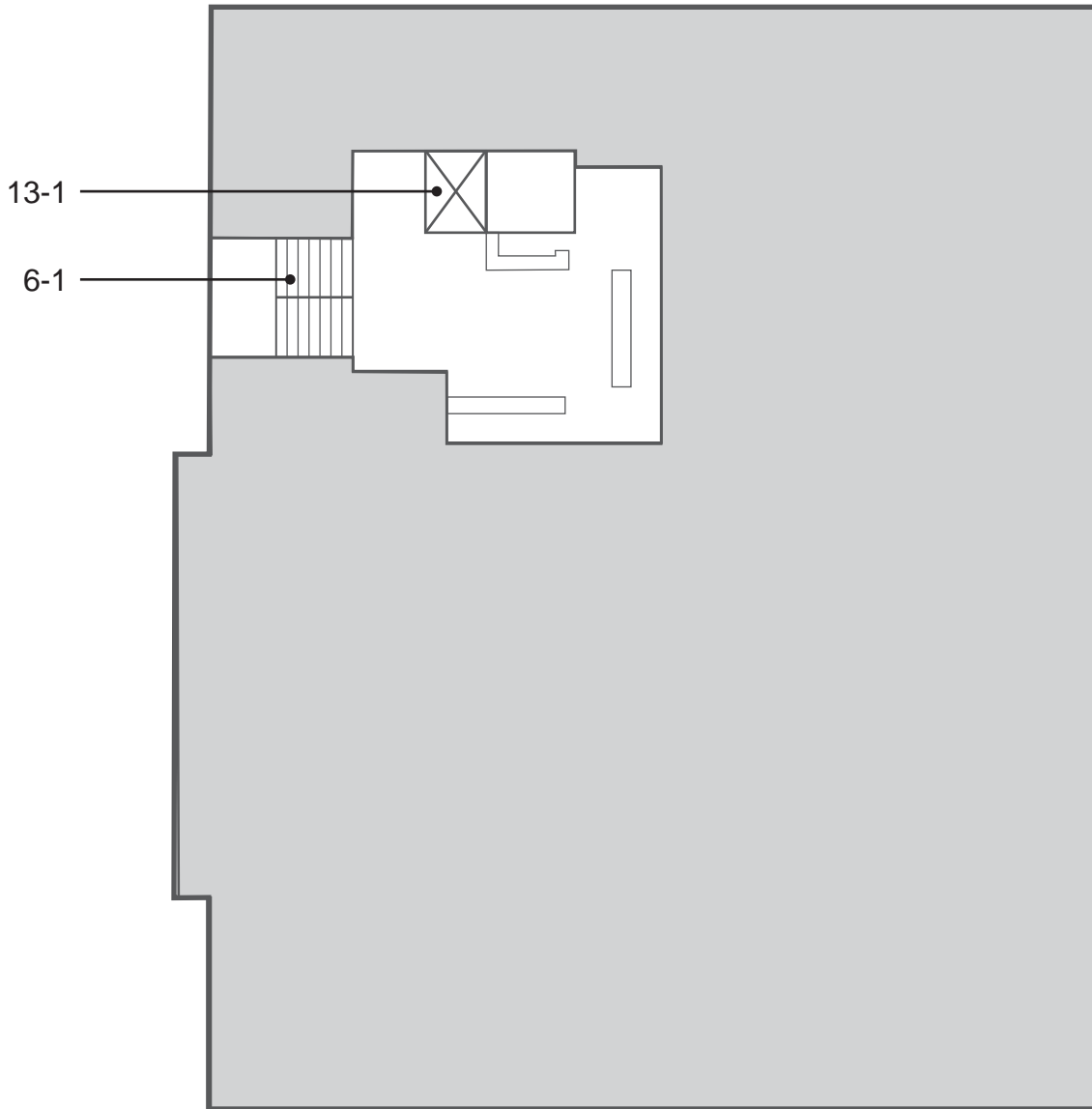

Cupertino ADA

City Hall

Basement	
6 - 1 Stairway	Category: 1
Install tread striping	\$60
Notes: No tread striping provided on top and bottom risers on two flights of stairs.	
CBC: 11B-504.4.1	
Other: -	
Raise or lower existing handrail	\$200
Notes: Handrail top surface is mounted 33" above the stair nosing on one flight of stairs and 32" above the second flight of stairs (34" min to 38" max).	
CBC: 11B-505.4	
Other: ADA 505.4	
13 - 1 Elevator	Category: 1
Enlarge elevator	\$55,000
Notes: Elevator car with off-centered door has an inside car dimension of 66.25" from side wall to side wall (68" wide min, and 51" from front wall to back wall).	
CBC: 11B-407.4.1	
Other: ADA 407.4.1	
Adjust elevator controls and labeling	\$900
Notes: Phone control button is not identified with a tactile sign.	
CBC: 11B-407.4.9	
Other: ADA 407.4.9, ADA 703.2	
Adjust or provide elevator signals and indicators	\$2,000
Notes: A verbal annunciator that announces the floor at the stop is not provided.	
CBC: 11B-407.4.8.2	
Other: ADA 407.4.8.2	

City Hall - Main Floor
10300 Torre Ave
Cupertino, CA

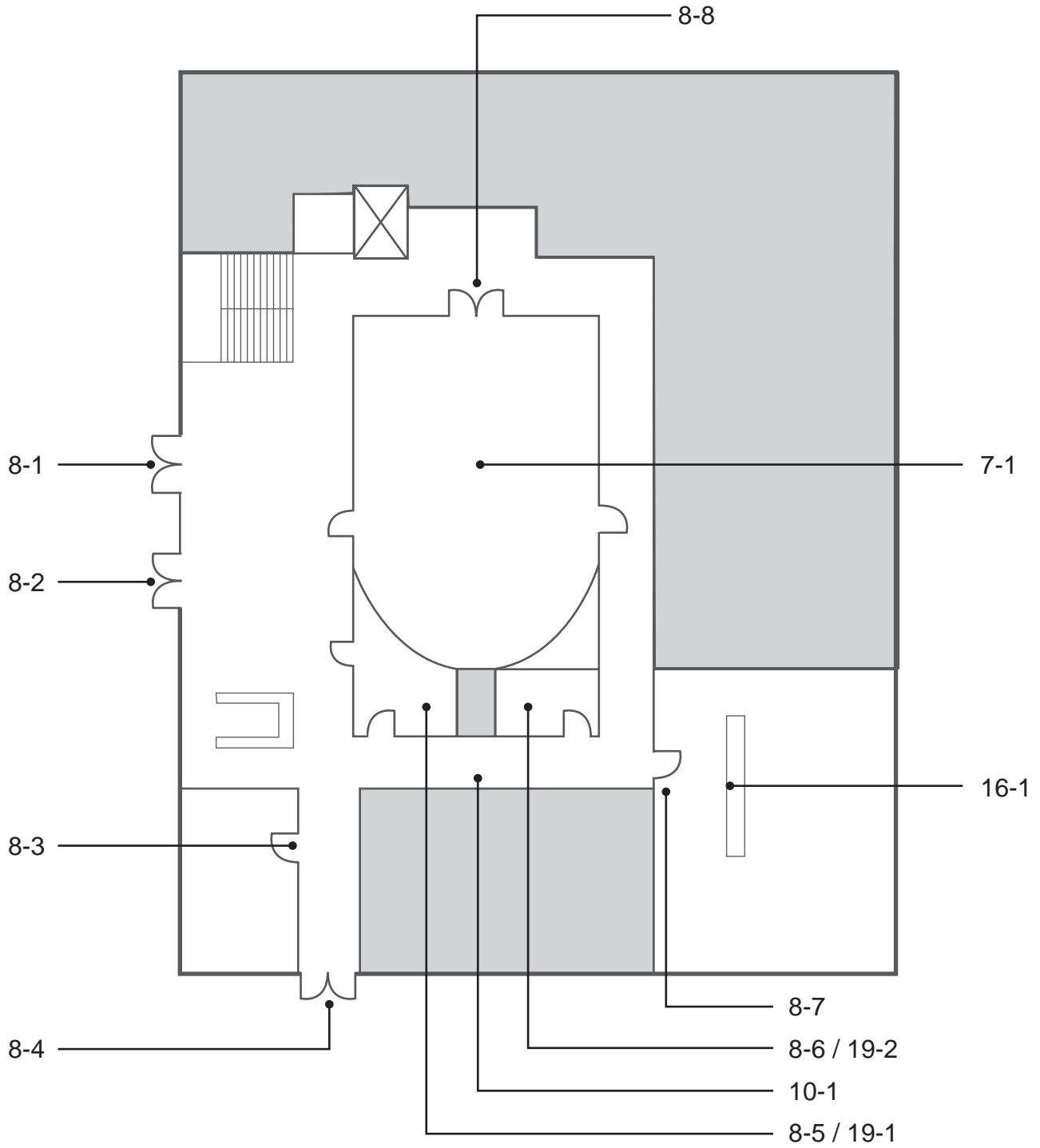

Cupertino ADA

City Hall

Floor 1	
7 - 1	Hazard Category: 4
Remove overhanging or protruding objects	\$500
Notes: Four video cameras protrude 18" from the wall at 59" AFF in the conference room (protrusion more than 4" must be mounted below 27" or above 80").	
CBC: 11B-307.2	
Other: ADA 307.2	
8 - 1	Door/Gate Category: 1
Provide an International Symbol of Accessibility	\$250
Notes: Accessible entry is not marked by the International Symbol of Accessibility.	
CBC: 11B-216.6	
Other: ADA 216.6, ADA 703.7.2.1	
Install or modify sign	\$250
Notes: A tactile and Braille EXIT sign is not provided for emergency exit.	
CBC: 1011	
Other: ADA 216.4.1, ADA 703.4.1	
Regrade surface	\$2,500
Notes: Slope of the maneuvering clear area is 4.5% (2% max).	
CBC: 11B-404.2.4.4	
Other: ADA 404.2.4.4	
8 - 2	Door/Gate Category: 1
Provide an International Symbol of Accessibility	\$250
Notes: Accessible entry is not marked by the International Symbol of Accessibility.	
CBC: 11B-216.6	
Other: ADA 216.6, ADA 703.7.2.1	
Install or modify sign	\$250
Notes: A tactile and Braille EXIT sign is not provided for emergency exit.	
CBC: 1011	
Other: ADA 216.4.1, ADA 703.4.1	
Regrade surface	\$2,500
Notes: Slope of the maneuvering clear area is 4.9% (2% max).	
CBC: 11B-404.2.4.4	
Other: ADA 404.2.4.4	
8 - 3	Door/Gate Category: 2
Install or modify sign	\$250
Notes: A tactile and Braille permanent room sign is not provided.	
CBC: 11B-216.2	
Other: ADA 216.2	

Cupertino ADA

City Hall

Floor 1	
8 - 4	Door/Gate Category: 1
Adjust door closer	\$125
Notes: Door opening force is 7 lbs (5 lbs max).	
CBC: 11B-404.2.9	
Other: ADA 404.2.9	
Install or modify sign	\$250
Notes: A tactile and Braille EXIT sign is not provided in passageway for emergency exit.	
CBC: 1011	
Other: ADA 216.4.1, ADA 703.4.1	
Regrade surface	\$2,500
Notes: Slope of the maneuvering clear area is 3.3% (2% max).	
CBC: 11B-404.2.4.4	
Other: ADA 404.2.4.4	
8 - 5	Door/Gate Category: 2
Enlarge door opening	\$1,650
Notes: Height of door closer is 76 3/8" AFF (78" min).	
CBC: 11B-404.2.3	
Other: ADA 404.2.3.2	
8 - 6	Door/Gate Category: 2
Enlarge door opening	\$1,650
Notes: Height of door closer is 76.5" AFF (78" min at door closer).	
CBC: 11B-404.2.3	
Other: ADA 404.2.3.2	
8 - 7	Door/Gate Category: 2
Adjust door closer	\$125
Notes: Door opening force is 7 lbs (5 lbs max).	
CBC: 11B-404.2.9	
Other: ADA 404.2.9	
Install or modify sign	\$250
Notes: A tactile and Braille permanent room sign is not provided in the administration office.	
CBC: 11B-216.2	
Other: ADA 216.2	

Cupertino ADA

City Hall

Floor 1		
8 - 8	Door/Gate	Category: 2
Adjust door closer		\$125
Notes: On the day of survey the automatic door was locked from the outside of the building. Door's closing force and closing time not surveyed.		
CBC: 11B-404.2.8.1, 11B-404.3		
Other: ADA 404.2.8.1, ADA 404.3		
10 - 1	Drinking Fountain	Category: 3
Replace fountain		\$3,000
Notes: Bubbler height is 30.75" AFF. A standing person drinking fountain is not provided (38"min to 43" max for a standing person fountain).		
CBC: 11B-602.7		
Other: ADA 602.7		
Raise or lower fountain		\$1,500
Notes: Space between floor/ground and bottom of fountain is 26.25" (27" min).		
CBC: 11B-306.3		
Other: ADA 306.3, ADA 306.3.1		
16 - 1	Built-in Elements	Category: 2
Provide an accessible counter		\$1,500
Notes: Counter is 42" AFF, no accessible counter provided (34" max).		
CBC: 11B-904.4		
Other: ADA 904.4.1		

Cupertino ADA

City Hall

Floor 1	
19 - 1 Multiple User Restroom	Category: 2
Install restroom sign	\$250
Notes: Federal sign is not provided in the men's restroom. State sign is centered at 65" AFF (60" AFF).	
CBC: 11B-216.8, 11B-703.7.2.6	
Other: ADA 703	
Replace or reposition mirror	\$150
Notes: Bottom of the mirror's reflecting surface is 40.5" AFF (40" max).	
CBC: 11B-603.3	
Other: ADA 603.3	
Reposition clothing hooks	\$125
Notes: Height of coat hook is 69" (48" max).	
CBC: 11B-603.4	
Other: ADA 308	
Modify lavatory or counter clearances	\$1,500
Notes: Clear space beneath the lavatory is 28.25" to front apron (29" min). Knee space measured at 8" deep from the centerline of the lavatory is 26.5" AFF (27" min).	
CBC: 11B-306.3.1, 11B-306.3.3	
Other: ADA 306.3, ADA 306.3.3	
Provide clear floor or turning space	\$3,000
Notes: Clear space in front of the urinal is 27.25" wide (30" min). No turning space provided (turning space of 60" min).	
CBC: 11B-305, 11B-603.2.1	
Other: ADA 304.3, ADA 305.5, ADA 603.2.1	
Provide or replace compartment door hardware	\$175
Notes: Compartment door does not have handle on the inside of the door and is not self-closing (Compartment door must have U-shaped handles both inside and outside of the door and be self-closing).	
CBC: 11B-604.8.1.2	
Other: ADA 604.8.1.2	
Modify stall partitions	\$500
Notes: Water closet compartment is 57.5" wide (60" min).	
CBC: 11B-604.8.1.1	
Other: ADA 604.3.1	
Replace toilet or adjust toilet seat height	\$3,000
Notes: Water closet seat height is 15.75" AFF (17" min to 19" max).	
CBC: 11B-604.4	
Other: ADA 604.4	

Cupertino ADA

City Hall

Floor 1	
19 - 1 Multiple User Restroom	Category: 2
Replace or reposition dispenser	\$125
Notes: Centerline of the toilet paper is positioned 1" in front of the water closet (7" min to 9" max).	

CBC: 11B-604.7	
Other: ADA 604.7	
Install or modify visible fire alarm	\$250
Notes: Visible fire alarm is not provided.	

CBC: 11B-702.1	
Other: ADA 702.1	

Cupertino ADA

City Hall

Floor 1	
19 - 2 Multiple User Restroom	Category: 2
Install or modify visible fire alarm	\$250
Notes: A visible fire alarm is not provided.	
CBC: 11B-702.1	
Other: ADA 702.1	
Replace or reposition mirror	\$150
Notes: Bottom of the mirror's reflecting surface is 40.5" AFF (40" max).	
CBC: 11B-603.3	
Other: ADA 603.3	
Reposition clothing hooks	\$125
Notes: Height of coat hook is 58.75" AFF (48" max).	
CBC: 11B-308	
Other: ADA 308	
Modify lavatory or counter clearances	\$1,500
Notes: Clear space beneath the lavatory is 28.5" to front apron (29" min).	
CBC: 11B-306.3.1	
Other: -	
Provide or replace compartment door hardware	\$175
Notes: Compartment door does not have handle on the inside of the door and is not self-closing (Compartment door must have U-shaped handles both inside and outside of the door and be self-closing).	
CBC: 11B-604.8.1.2	
Other: ADA 604.8.1.2	
Modify stall partitions	\$500
Notes: Water closet compartment is 57.5" wide (60" min).	
CBC: 11B-604.8.1.1	
Other: ADA 604.3.1	
Reposition toilet flush controls	\$750
Notes: Flush control is not located on the wide side of the water closet (flush control is required to be located on the open side of the fixture).	
CBC: 11B-604.6	
Other: ADA 604.6	
Replace toilet or adjust toilet seat height	\$3,000
Notes: Water closet seat is 15.75" AFF (17" min to 19" max).	
CBC: 11B-604.4	
Other: ADA 604.4	

Cupertino ADA

City Hall

Floor 1	
19 - 2	Multiple User Restroom
	Category: 2
Replace or reposition dispenser	\$125
Notes: Coin slot at sanitary napkin dispenser is 48" AFF (40" max).	
CBC: 11B-603.5	
Other: -	

APPENDIX A - 14

Civic Center Master Plan City Council Presentation
(P+W, Oct 21, 2014)

This page intentionally left blank.

CIVIC CENTER MASTER PLAN CITY COUNCIL MEETING



CITY OF CUPERTINO
OCTOBER. 21, 2014



CIVIC CENTER MASTER PLAN

WHY WE ARE HERE

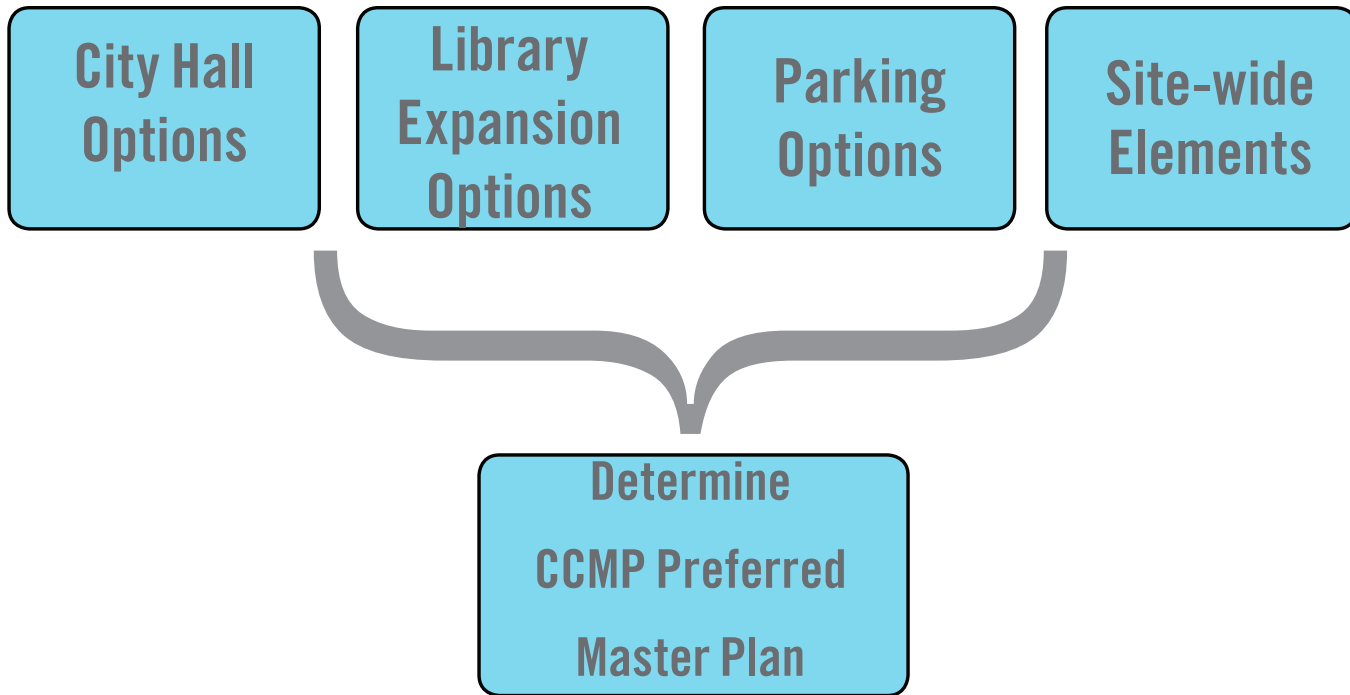

CIVIC CENTER MASTER PLAN COMMUNITY WORKSHOP JULY 30



October 21, 2014



WHAT YOU ASKED OF US...

CONSIDER REUSING THE EXISTING CITY HALL

PROVIDE A COST & BENEFIT COMPARISON FOR CITY HALL SCENARIOS

PROVIDE COMPARABLE PRECEDENTS FOR CITY HALL

CITY HALL SCENARIOS

A

Existing City Hall

+ life safety (\$14.3M)

+ Site Work (not applicable)

B

Existing City Hall

+ immediate occupancy *, EOC (\$18M)

+ Site Work (not applicable)

C

**Existing City Hall
Complete Remodel**

+ immediate occupancy*,
EOC (\$26.8M)

+ Site Work (not applicable)

D

New City Hall

+ EOC (\$33.8M)

+ Site Work (\$3.4M)

E

New City Hall

+ Council Chambers (\$40.5M)

+ Site Work (\$3.4M)

CITY HALL SCENARIOS

LIBRARY PROGRAM

A Existing City Hall

+ life safety (\$14.3M)

+ Site Work (not applicable)

L1 Expand Library (\$3.1M)

B Existing City Hall

+ immediate occupancy *, EOC (\$18M)

+ Site Work (not applicable)

L1 Expand Library (\$3.1M)

C Existing City Hall Complete Remodel

+ immediate occupancy*,
EOC (\$26.8M)

+ Site Work (not applicable)

L1 Expand Library (\$3.1M)

D New City Hall

+ EOC (\$33.8M)

+ Site Work (\$3.4M)

L1 Expand Library (\$3.1M)

L2 Ex. Community Hall (\$0)

E New City Hall

+ Council Chambers (\$40.5M)

+ Site Work (\$3.4M)

L2 Ex. Community Hall (\$0)

CITY HALL SCENARIOS

LIBRARY PROGRAM

STRUCTURED PKG SOLUTION

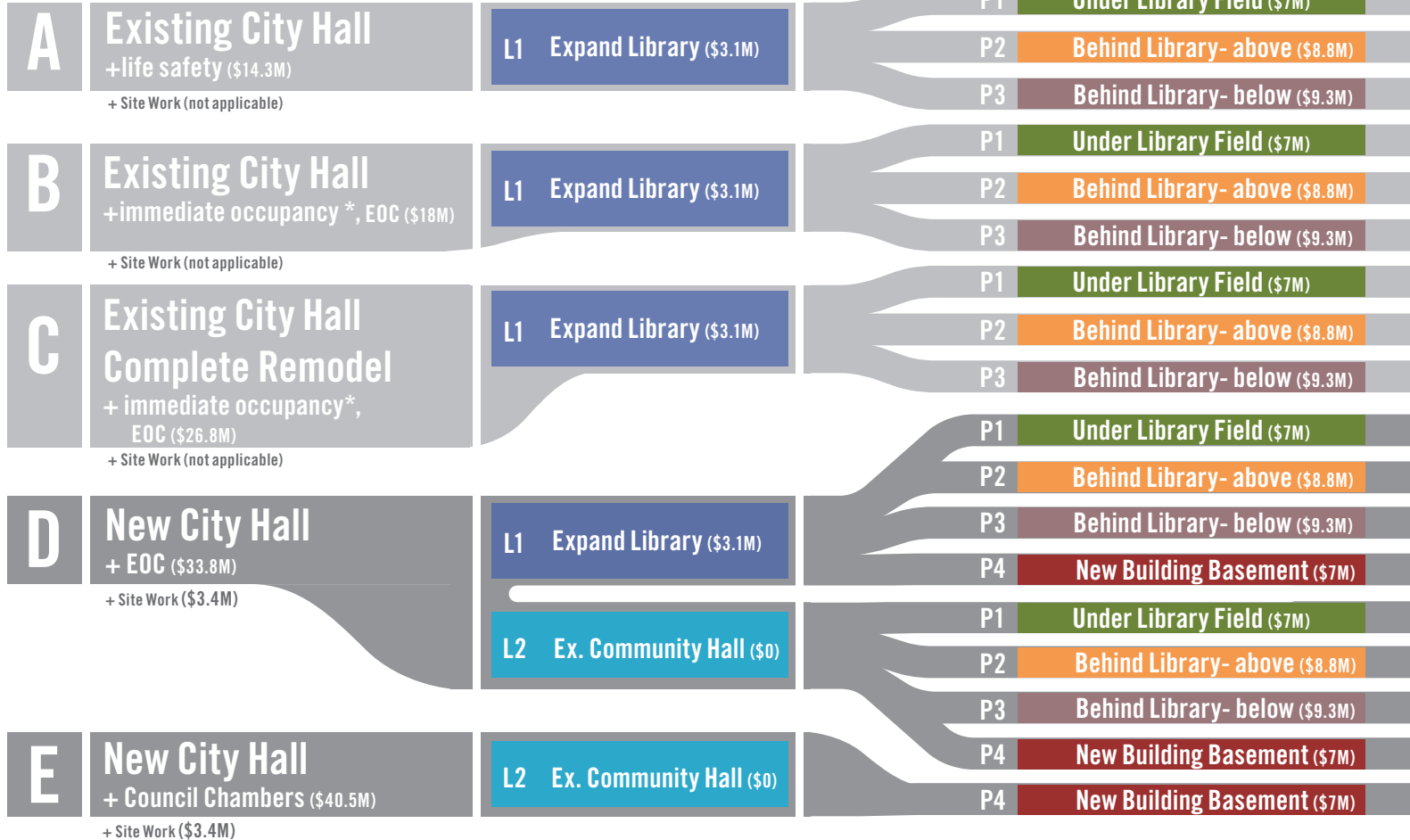

CITY HALL SCENARIOS

STRUCTURAL TERMS EXPLAINED

Seismic/ Life Safety

- Life safety criteria implies significant damage to structure and non structural systems
- Facility relocation and downtime is anticipated
- Repairs may be costly or infeasible

Immediate Occupancy

- Prescriptive code criteria for Immediate Occupancy implies stronger structure
- Does not explicitly assure performance goals, relies on structural damage to absorb seismic energy
- May require costly repairs and facility downtime following major earthquake

Performance Based (Immediate Occupancy/ Fully Operational)

- Performance based to provide tailored structure to meet resiliency goals
- Explicit and quantified performance metrics for risk and life-cycle cost assessment
- Effective use of currently available technology (seismic isolation, viscous damping) to meet long term goals

EXISTING BUILDING ASSESSMENT

MECHANICAL

- All Mechanical Systems are 30+ years old, inefficient and need to be replaced
- Current codes require systems to be relocated elsewhere as they are not allowed to be in the same space
- Systems maintenance costs can be greatly reduced *

ELECTRICAL

- All Electrical Systems are past 30+ years old, inefficient and need to be replaced
- Light Fixtures are not energy efficient and require replacement to meet current codes
- Systems maintenance costs can be greatly reduced *

PLUMBING

- Existing plumbing fixtures are water inefficient
- ADA issues with current restroom layout
- Old piping infrastructure

* Current building is operating inefficiently at \$3.63/SF-yr & 106 kBTU/SF-yr (vs \$1.00 / SF-yr & 25 kBTU/SF-yr for new buildings)

EXISTING BUILDING ASSESSMENT







ARCHITECTURAL IMPLICATIONS

- Clay roofing tiles need to be removed and replaced with a lightweight material
- Accessibility upgrades are needed throughout
- Elevator and shaft needs to be replaced / enlarged
- Main stair needs upgrading to accommodate exiting
- Current facility does not meet requirements to house an EOC

ARCHITECTURAL CHALLENGES

- Majority of public interface are accessed through dark corridors or are in the basement
- Lack of daylight in basement workspaces / meeting spaces
- Current layout does not accommodate for projected 10% growth of city staff
- Workstations are inefficient and inflexible

CITY HALL COMPONENTS

						
SEISMIC UPGRADES (LIFE SAFETY)	SEISMIC UPGRADES (IMMEDIATE OCCUPANCY)	EMERGENCY OPERATIONS CENTER	MEP SYSTEMS UPGRADES	CITY HALL 10% EXPANSION	INTEGRATED UNDERGROUND PARKING	COUNCIL CHAMBERS

SEISMIC (LIFE SAFETY)	A	●			◐			
SEISMIC (IMMEDIATE OCCUPANCY) W/ EOC	B	●	◐	◐	◐			
EXISTING CITY HALL COMPLETE REMODEL	C	●	◐	◐	◐	●		
NEW CITY HALL BUILDING	D	●	●	●	●	●	●*	
NEW CITY HALL + COUNCIL CHAMBERS	E	●	●	●	●	●	●	●

* OTHER STRUCTURE PARKING SOLUTIONS POSSIBLE

● OPTIMAL

◐ LIMITED

A: LIFE SAFETY UPGRADE



CITY HALL

CITY HALL

STRUCTURAL (LIFE SAFETY)

- Roof Reinforcement
- Concrete Column Reinforcement (Fiber Wrap or secondary steel columns)
- Additional shear walls at ground level (at all 4 corners of building)
- Seismic Bracing of MEP equipment

MEP SYSTEMS

- Mechanical Equipment Relocation / Replacement
- Electrical Equipment Replacement
- Lighting Upgrades for T24 compliance
- \$2.78 / sf / year (vs \$3.65)
- 70kBtu / sf / year (vs 92kBtu)

ARCHITECTURAL

- New Metal Roof
- Stair Upgrade
- Elevator replacement
- Accessibility Upgrades

B: IMMEDIATE OCCUPANCY + EOC

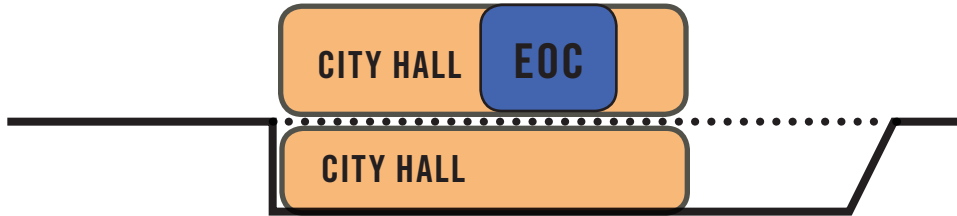

STRUCTURAL (IMMEDIATE OCCUPANCY)

- Additional shear walls at ground level
- Seismic Bracing of MEP equipment
- Extensive Roof Reinforcement
- Concrete Column Reinforcement (Fiber Wrap required)
- Thickening of shear walls at basement

MEP SYSTEMS

- Mechanical Equipment Relocation / Replacement
- Electrical Panels / Equipment Replacement
- Lighting Upgrades for T24 compliance
- \$2.78 / sf / year (vs \$3.65)
- 70kBtu / sf / year (vs 92kBtu)
- Generator Replacement
- Pipe Anchorage and Seismic Attachments

ARCHITECTURAL

- New Roof Material
- Stair Upgrade
- Upgrade construction / finishes for fire rating
- Accessibility Upgrades
- Possible EOC Redesign
- Glazing replacement may be required if non tempered

C: COMPLETE REMODEL

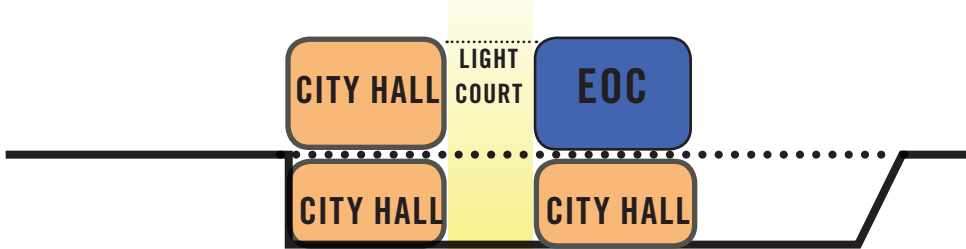

STRUCTURAL (IMMEDIATE OCCUPANCY)

- Additional shear walls at ground level
- Seismic Bracing of MEP equipment
- Extensive Roof Reinforcement
- Concrete Column Reinforcement (Fiber Wrap required)
- Thickening of shear walls at basement
- Additional slab reinforcement at lightwell openings

MEP SYSTEMS

- Complete MEP Equipment Relocation & Replacement
- Generator Replacement
- New Ductwork and conduit throughout
- New High Efficiency Lighting Layout / Fixtures
- \$1.59 / sf / year (vs \$3.65)
- 40kBtu / sf / year (vs 92kBtu)

ARCHITECTURAL

- New Roof Material and Opening
- Accommodates City Hall 10% Expansion
- New layout to reflect future workspace trends
- Improved Public Experience
- Improved Daylighting

C: COMPLETE REMODEL

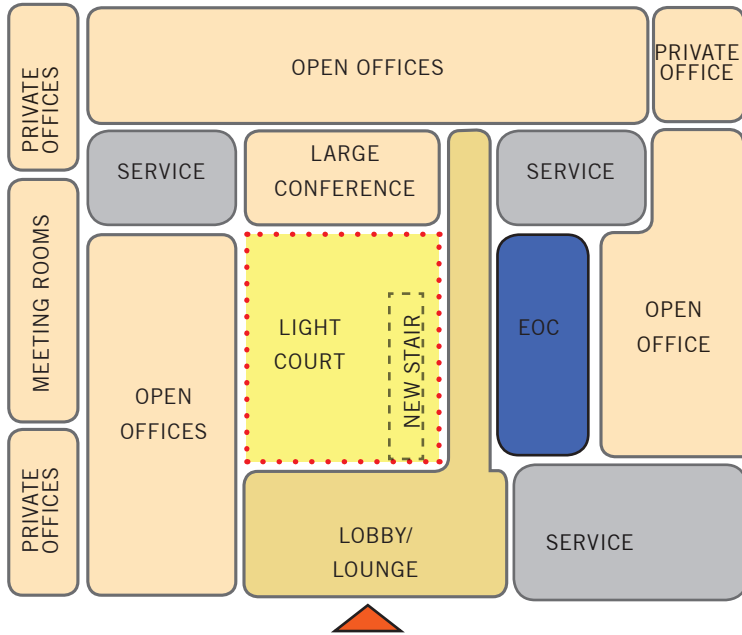

GROUND FLOOR PLAN

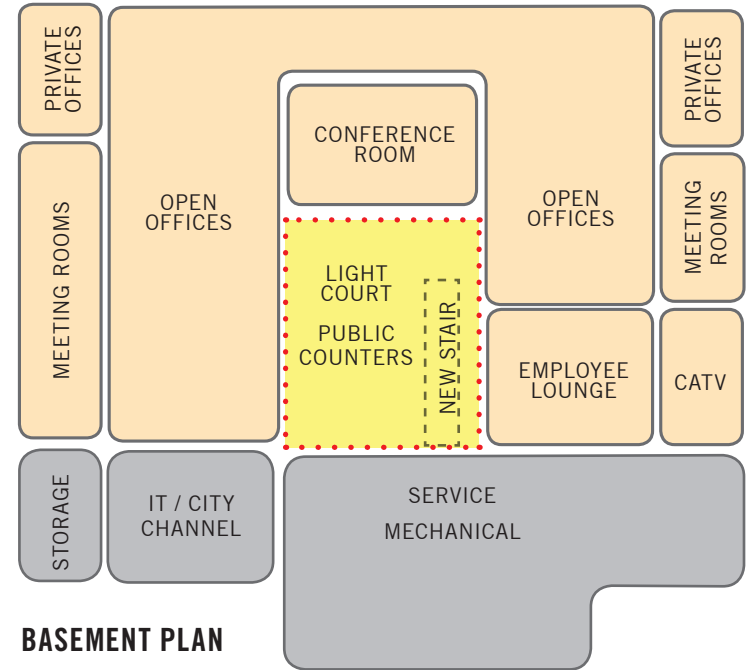

BASEMENT PLAN

D: NEW BUILDING

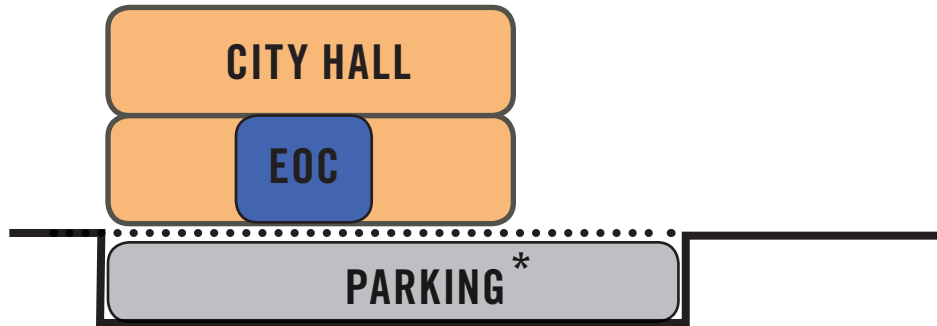

* Alternative structured parking solutions possible

STRUCTURAL

- New Structure that will be designed to explicitly handle the seismic requirements for immediate occupancy
- 50 Year Building

MEP SYSTEMS

- New Energy Efficient Systems that can be integrated in the building to minimize building maintenance costs.
- LEED Platinum
- Systems optimized for comfort (thermal, lighting, acoustics, user control, biophilia) and productivity
- **\$.99 / sf / year (vs \$3.65)**
- **25kBtu / sf / year (vs 92kBtu)**

ARCHITECTURAL

- Enhanced Civic Identity
- Accommodates City Hall 10% Expansion
- New layout to reflect future workspace trends
- Improved Public Experience / Amenities
- Maximize Daylighting
- Integrated Underground parking
- Flexibility and Expandability

E: NEW BUILDING+ COUNCIL CHAMBERS

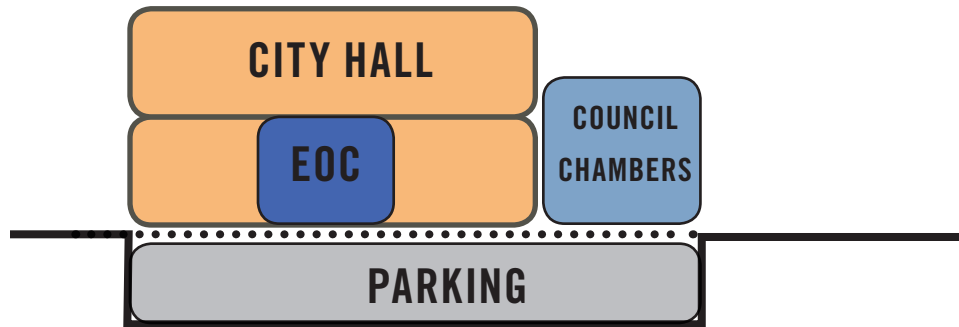

STRUCTURAL

- New Structure that will be designed to explicitly handle the seismic requirements for immediate occupancy
- 50 year life span







MEP SYSTEMS























- New Energy Efficient Systems that can be integrated in the building to minimize building maintenance costs.
- LEED Platinum
- Systems optimized for comfort (thermal, lighting, acoustics, user control, biophilia) and productivity
- \$.99 / sf / year (vs \$3.65)
- 25kBtu / sf / year (vs 92kBtu)

ARCHITECTURAL

- Enhanced Civic Identity
- Accommodates City Hall 10% Expansion
- New layout to reflect future workspace trends
- Improved Public Experience / Amenities
- Maximizes Daylighting
- Integrated Underground parking
- Flexibility and Expandability
- [Integrated Program enhances efficiency & maintenance](#)

EVALUATION CRITERIA

							
COST PER SQUARE FT.	IMMEDIATE OCCUPANCY POST EVENT	SEISMIC RESILIENCY	OPERATIONS MAINTENANCE SAVINGS	LIFE CYCLE COSTS REDUCTION	ADAPTABILITY + FLEXIBILITY	IMPROVED DAYLIGHTING + WORKPLACE	CIVIC IDENTITY + USER EXPERIENCE

SEISMIC (LIFE SAFETY)	A	\$333.00							
SEISMIC (IMMEDIATE OCCUPANCY) W/ EOC	B	\$441.00							
EXISTING CITY HALL COMPLETE REMODEL	C	\$663.00							
NEW CITY HALL BUILDING	D	\$646.00							
NEW CITY HALL + COUNCIL CHAMBERS	E	\$626.00							

OPTIMAL  LIMITED 

LIBRARY PROGRAM EXPANSION

CITY HALL SCENARIOS

LIBRARY PROGRAM

STRUCTURED PKG SOLUTION

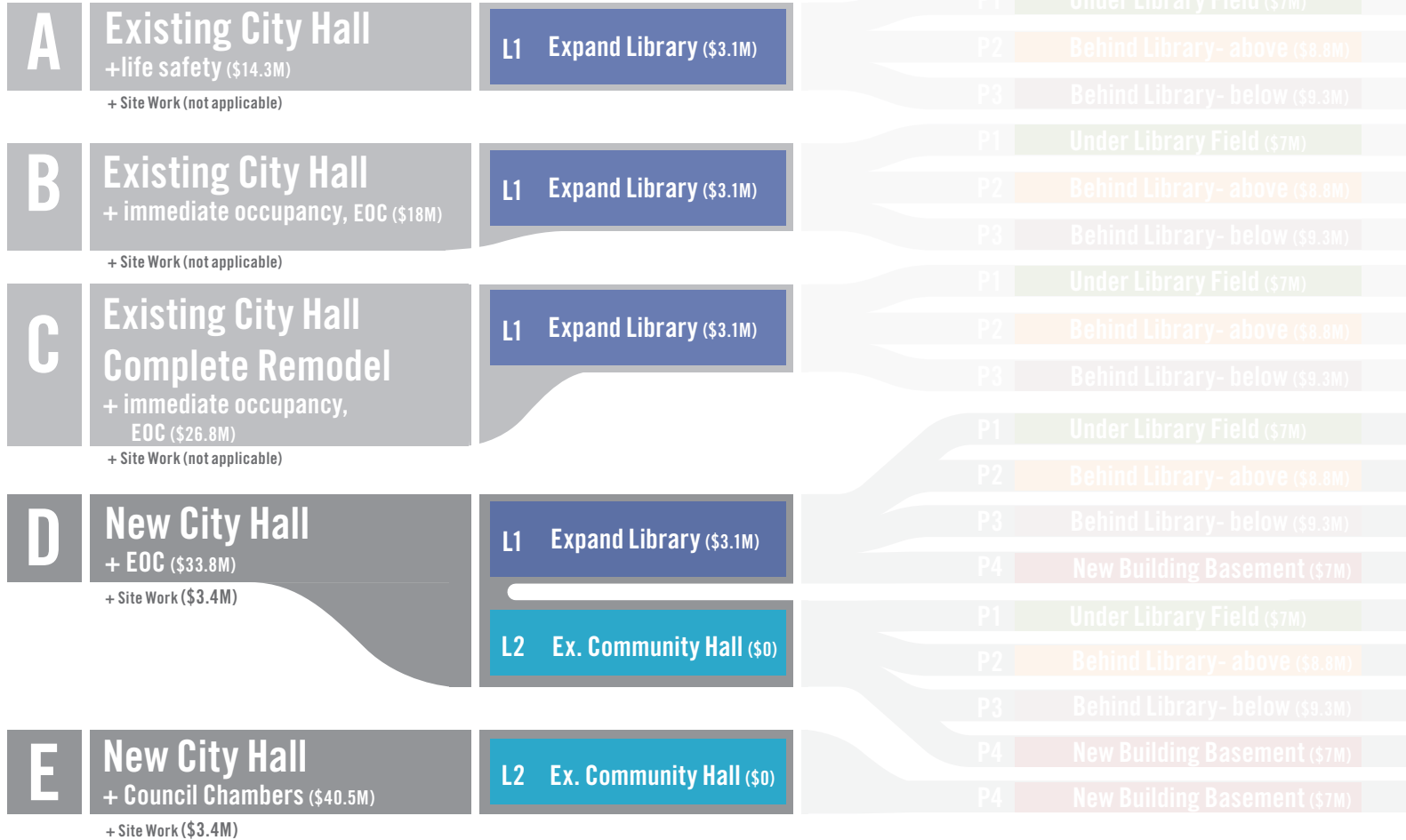

CIVIC CENTER MASTER PLAN

L1: LIBRARY EXPANSION

OPTION 1: PROGRAM ROOM EXPANSION

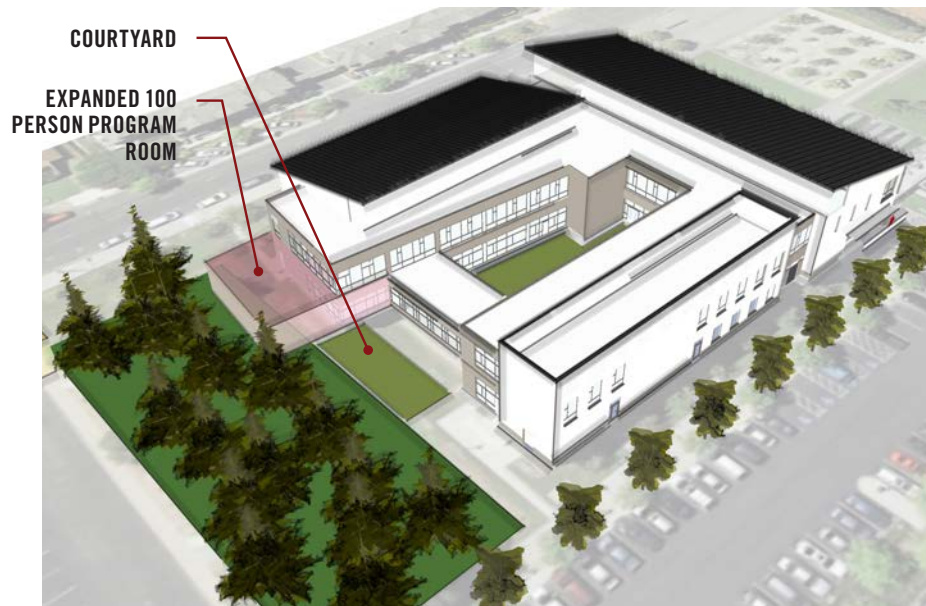

summary

- Expands the current story room (540 sf) into a 100 person program / meeting room (2,500 sf)
- Will have its own restrooms and can function even when the rest of the library is closed
- Includes a new south entrance from parking lot
- Careful planning avoids the Memorial Grove however a survey is necessary to assess any impact to the redwood trees root system

CIVIC CENTER MASTER PLAN

L2: COMMUNITY HALL



OPTION 2: REPURPOSE COMMUNITY HALL

summary

- Library takes control of Community Hall
- City reserves it for City Council meetings

PARKING ALTERNATIVES

CITY HALL SCENARIOS

LIBRARY PROGRAM

STRUCTURED PKG SOLUTION

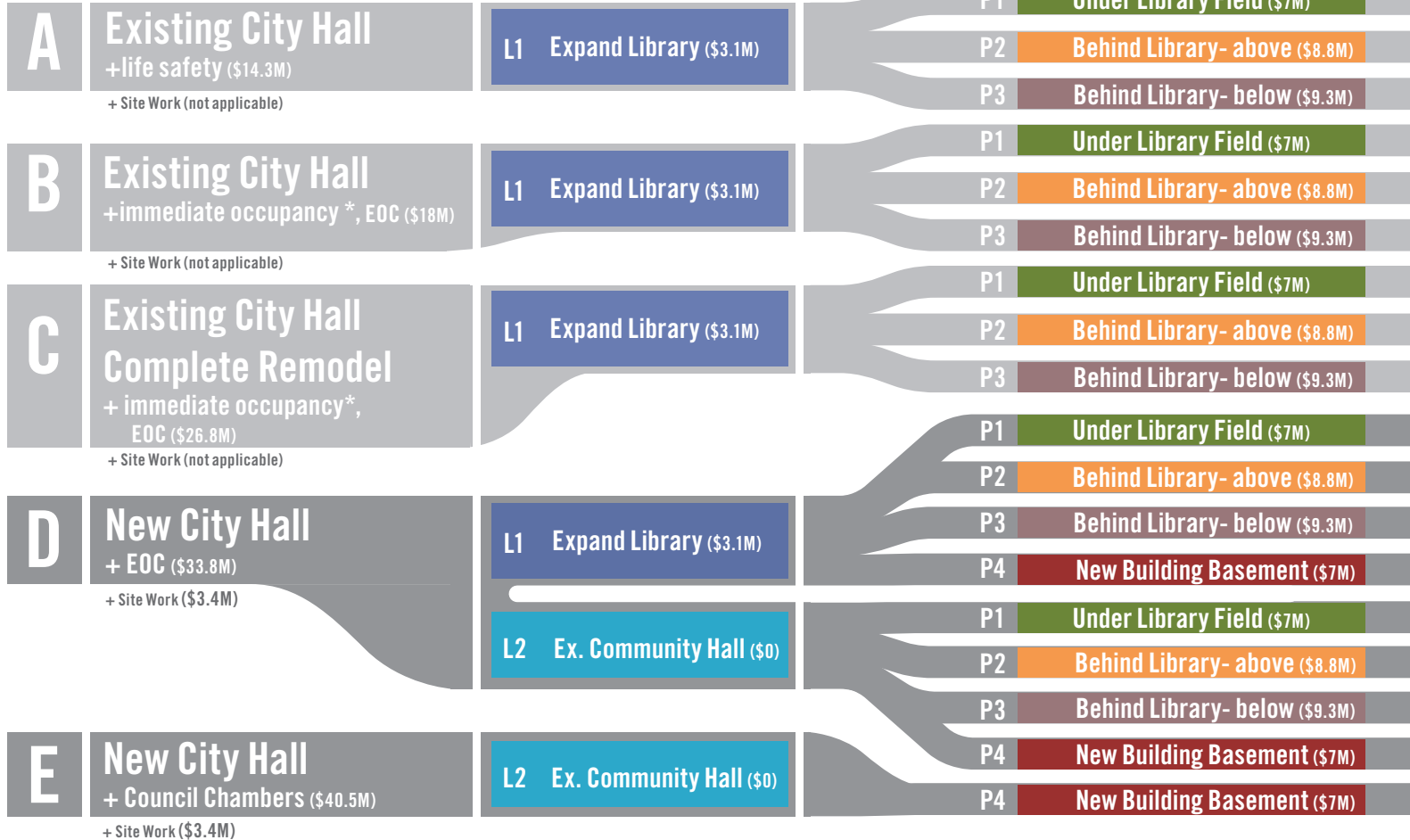

CIVIC CENTER MASTER PLAN

P1: UNDER LIBRARY FIELD



summary

- Parking structure is entirely underground
- Accounts for an additional 100 spaces
- Field remains fully functional after construction
- Mechanically ventilated and artificially lit
- Accessible from Torre Avenue (with option to add secondary entrance/exit)
- Minimal visual obstruction above grade

Library Field

Underground Parking

\$53K/space X 100

P2: BEHIND LIBRARY- ABOVE GROUND

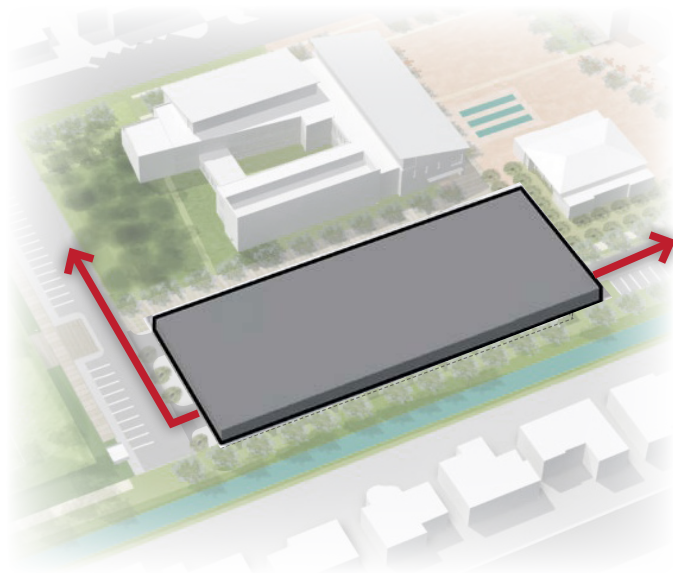

summary

Parking garage with 1 deck level (estimated at 15' high) located behind library on existing surface lot. Accounts for 100 additional spaces and replacement of 130 existing spaces.

- Convenient and centrally located to Library Plaza
- Can be phased independent of City Hall
- Requires removal and replacement of existing parking lot (130 spaces)
- Site-wide circulation is constrained
- Hinders future open and built expansion possibilities

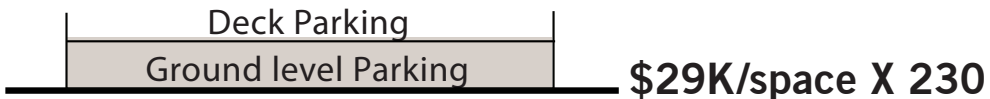

CIVIC CENTER MASTER PLAN

P3: BEHIND LIBRARY- BELOW GROUND

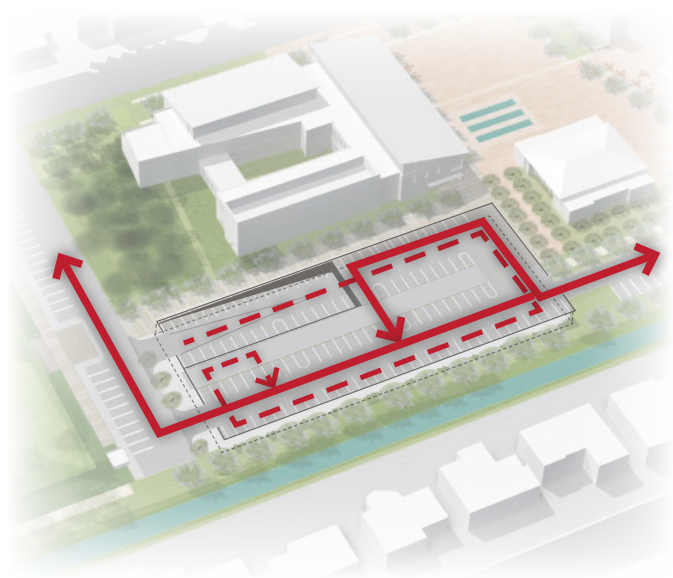

Surface Parking

Underground Parking

\$30.5K/space X 230



summary

Parking garage with 1 level below ground located behind library on the existing surface lot. Accounts for 100 additional spaces and replacement of 130 existing spaces.

- Convenient and centrally located to Library Plaza
- Can be phased independent of City Hall
- Requires removal and replacement of existing parking lot (130 spaces)
- Site-wide circulation is constrained
- Garage circulation within structure is constrained
- Hinders future open and built expansion possibilities
- Requires additional walls/fencing around underground opening

CIVIC CENTER MASTER PLAN

P4: BELOW NEW CITY HALL

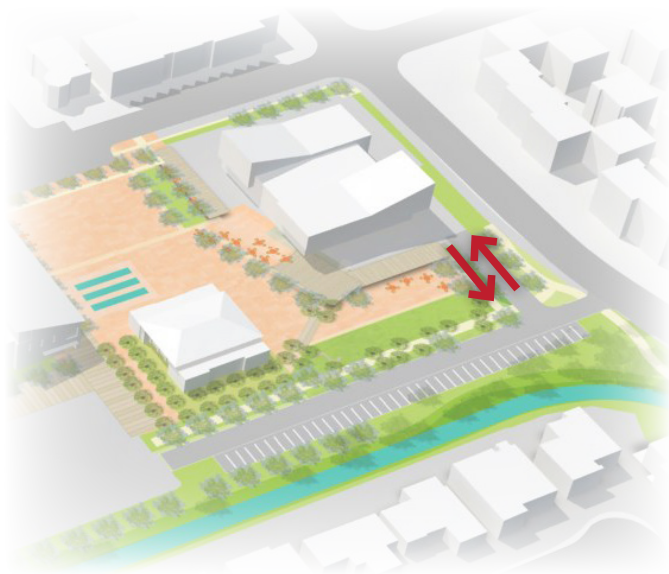

summary

Underground parking below a new City Hall.
Accounts for an additional 100 spaces.

- Utilizes the already excavated basement level
- Convenient and centrally located to Library Plaza
- Integrated with existing site circulation
- Does not impact existing surface parking lots

City Hall

Underground Parking

\$53K/space X 100

STRUCTURED PARKING SOLUTIONS

P1: UNDER LIBRARY FIELD



- Construction Cost: \$5.3M (100 spaces = \$53k/space)
- 100 new spaces

Net Const. Cost of 100 new spaces: **\$53K/space**

P2: BEHIND LIBRARY- ABOVE GRADE

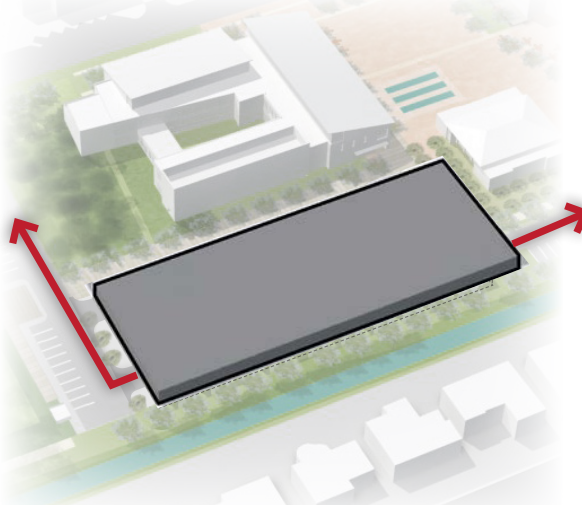

- Construction Cost: \$6.7M (230 spaces = \$29k/space)
- 230 spaces=130 spaces demolished & replaced
+ 100 new spaces

Net Const. Cost of 100 new spaces: **\$67K/space**

P3: BEHIND LIBRARY- BELOW GRADE

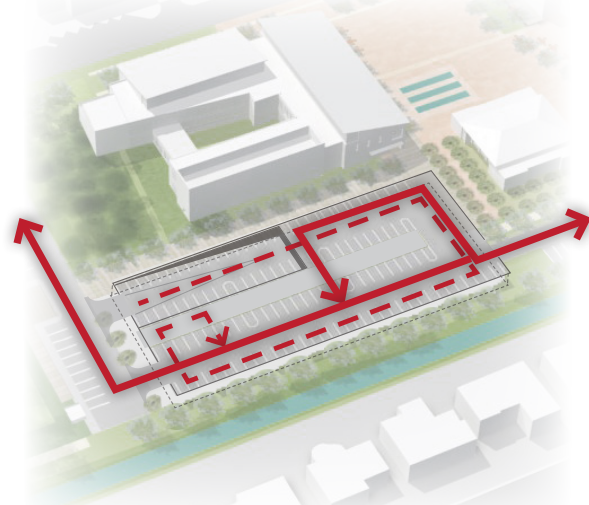

























- Construction Cost: \$7M (230 spaces = \$30.5k/space)
- 230 spaces=130 spaces demolished & replaced
+ 100 new spaces

Net Const. Cost of 100 new spaces: **\$70K/space**

PREFERRED CCMP DECISION

EVALUATION CRITERIA

							
COST PER SQUARE FT.	IMMEDIATE OCCUPANCY POST EVENT	SEISMIC RESILIENCY	OPERATIONS MAINTENANCE SAVINGS	LIFE CYCLE COSTS REDUCTION	ADAPTABILITY + FLEXIBILITY	IMPROVED DAYLIGHTING + WORKPLACE	CIVIC IDENTITY + USER EXPERIENCE

SEISMIC (LIFE SAFETY)	A	\$333.00							
SEISMIC (IMMEDIATE OCCUPANCY) W/ EOC	B	\$441.00							
EXISTING CITY HALL COMPLETE REMODEL	C	\$663.00							
NEW CITY HALL BUILDING	D	\$646.00							
NEW CITY HALL + COUNCIL CHAMBERS	E	\$626.00							

OPTIMAL  LIMITED 

CITY HALL SCENARIOS

LIBRARY PROGRAM

STRUCTURED PKG SOLUTION

COST (in millions)

Scenario	Library Program	Structured Package Solution	Cost (in millions)
A Existing City Hall + life safety (\$14.3M) + Site Work (not applicable)	L1 Expand Library (\$3.1M)	P1 Under Library Field (\$7M)	\$ 24.4
		P2 Behind Library- above (\$8.8M)	\$ 26.2
		P3 Behind Library- below (\$9.3M)	\$ 26.6
B Existing City Hall + immediate occupancy *, EOC (\$18M) + Site Work (not applicable)	L1 Expand Library (\$3.1M)	P1 Under Library Field (\$7M)	\$ 28.1
		P2 Behind Library- above (\$8.8M)	\$ 29.9
		P3 Behind Library- below (\$9.3M)	\$ 30.3
C Existing City Hall Complete Remodel + immediate occupancy*, EOC (\$26.8M) + Site Work (not applicable)	L1 Expand Library (\$3.1M)	P1 Under Library Field (\$7M)	\$ 36.9
		P2 Behind Library- above (\$8.8M)	\$ 38.7
		P3 Behind Library- below (\$9.3M)	\$ 39.2
D New City Hall + EOC (\$33.8M) + Site Work (\$3.4M) ** + New City Hall basement fill (\$1.5M) in P1, P2 and P3	L1 Expand Library (\$3.1M)	P1 Under Library Field (\$7M)	\$ 48.8 **
		P2 Behind Library- above (\$8.8M)	\$ 50.6 **
		P3 Behind Library- below (\$9.3M)	\$ 51.1 **
		P4 New Building Basement (\$7M)	\$ 47.3
	L2 Ex. Community Hall (\$0)	P1 Under Library Field (\$7M)	\$ 45.7 **
		P2 Behind Library- above (\$8.8M)	\$ 47.5 **
		P3 Behind Library- below (\$9.3M)	\$ 48.0 **
E New City Hall + Council Chambers (\$40.5M) + Site Work (\$3.4M)	L2 Ex. Community Hall (\$0)	P4 New Building Basement (\$7M)	\$ 44.2
		P4 New Building Basement (\$7M)	\$ 50.9

CIVIC CENTER MASTER PLAN

RECOMMENDED CCMP OPTION

D

New City Hall

+ EOC (\$33.8M)

+ Site Work (\$3.4M)

L1 Expand Library (\$3.1M)

P4

New Building Basement (\$7M)

\$ 47.3M

LIBRARY EXPANSION:
Expanded for 100 person

NEW CITY HALL BUILDING:
with EOC

PARKING:
BELOW CITY HALL
100 Spaces

SITE WIDE ELEMENTS CONSIDERATIONS

SITE WIDE CONSIDERATIONS

UNSTRUCTURED OPEN SPACE

PEDESTRIAN / BIKE CONNECTION

PLAZA ENHANCEMENTS

FOOD OPTIONS

APPENDIX A - 15

Civic Center Master Plan Scenarios
(P+W, Dec 11, 2014)

This page intentionally left blank.

CIVIC CENTER MASTER PLAN SCENARIOS



CITY OF CUPERTINO
DECEMBER. 11, 2014



TIPPING MAR



FEHR PEERS



PDC Public Dialogue Consortium

PERKINS
+ WILL

AGENDA

December 11, 2014

BRIEF UPDATE ON PROJECT STATUS

MASTER PLAN OPTIONS

LIBRARY EXPANSION

FINANCIAL STRATEGIES DISCUSSION

EXISTING CONDITION



TORREY AVENUE

PACIFICA AVE

RODRIGUES AVE

LIBRARY FIELD

MEMORIAL GROVE

LIBRARY

LIBRARY PLAZA

CITY HALL

COMMUNITY HALL

SISTER CITY GROVE

SOUTH LOT

NORTH LOT

CREEK

CIVIC CENTER MASTER PLAN

IMMEDIATE IMPACTED AREAS

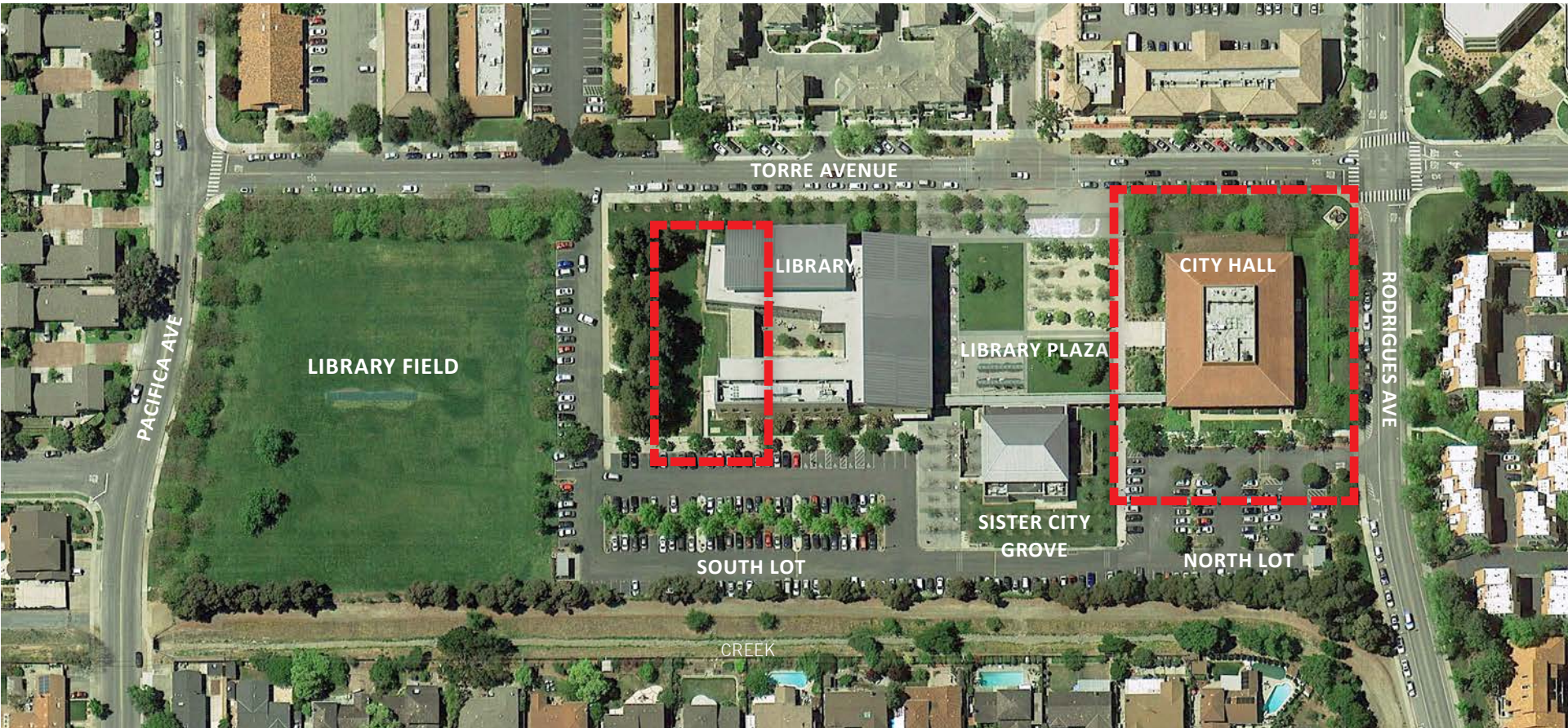

CIVIC CENTER MASTER PLAN

OPTION 1: OPTIMUM-SIZED PLAN

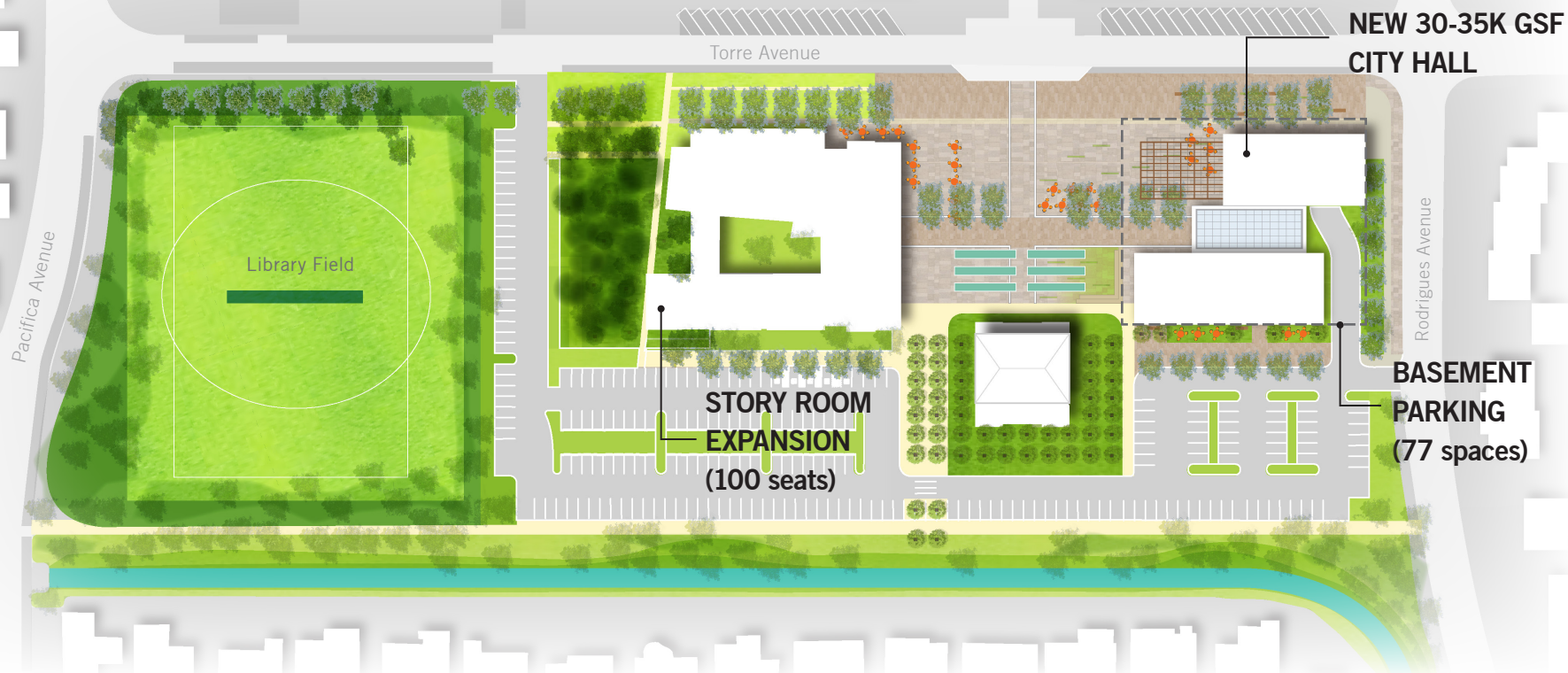

CIVIC CENTER MASTER PLAN

OPTION 2: MAXIMUM BUILD-OUT PLAN



CIVIC CENTER MASTER PLAN

NEW CITY HALL OPTION 1: 30/35K GSF

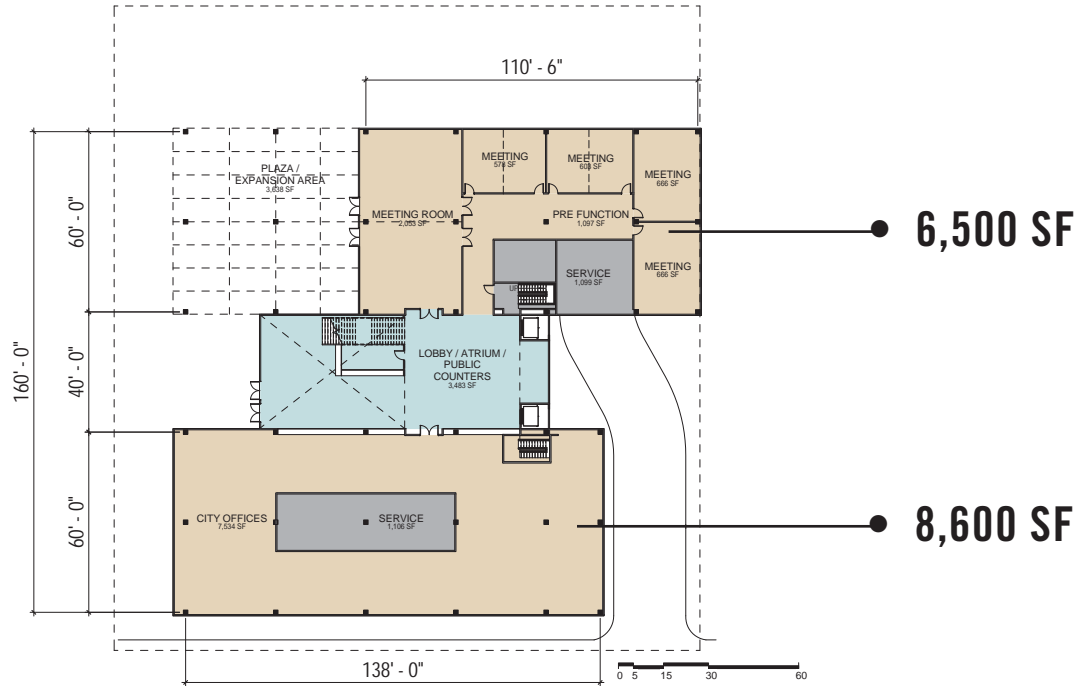

FIRST FLOOR PLAN

CIVIC CENTER MASTER PLAN

NEW CITY HALL OPTION 1: 30/35K GSF

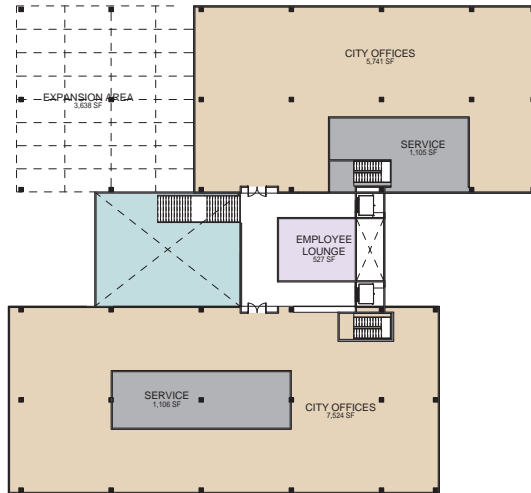

SECOND FLOOR PLAN

CIVIC CENTER MASTER PLAN

NEW CITY HALL OPTION 1: 30/35K GSF

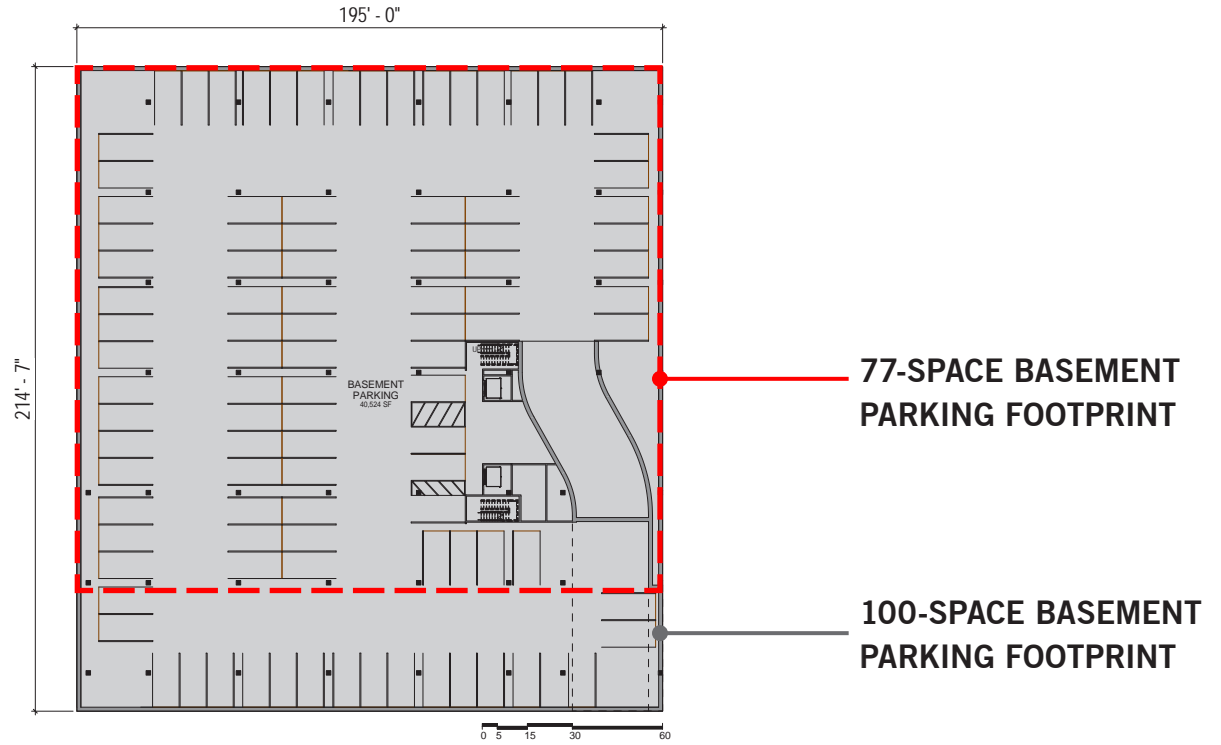

BASEMENT PARKING PLAN

CIVIC CENTER MASTER PLAN

NEW CITY HALL OPTION 1: 30/35K GSF

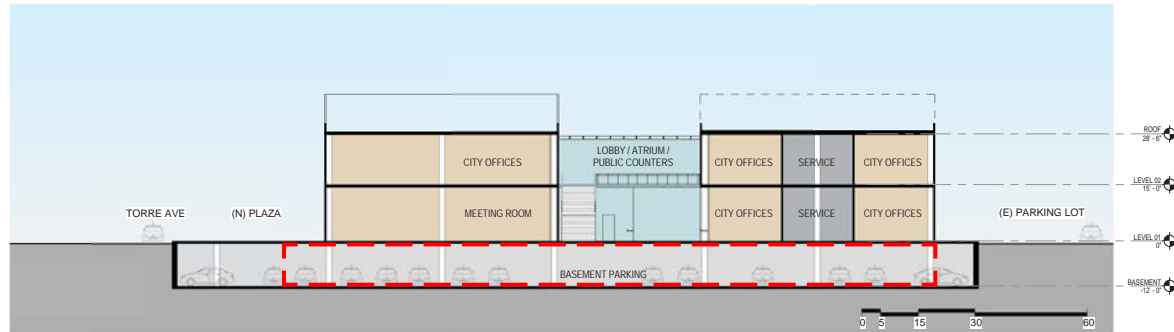
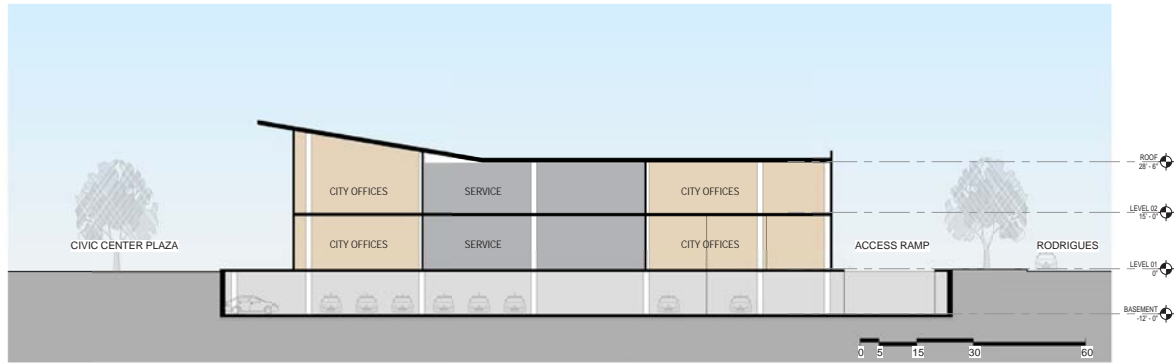

SECTIONS

CIVIC CENTER MASTER PLAN

NEW CITY HALL OPTION 2: 40K GSF

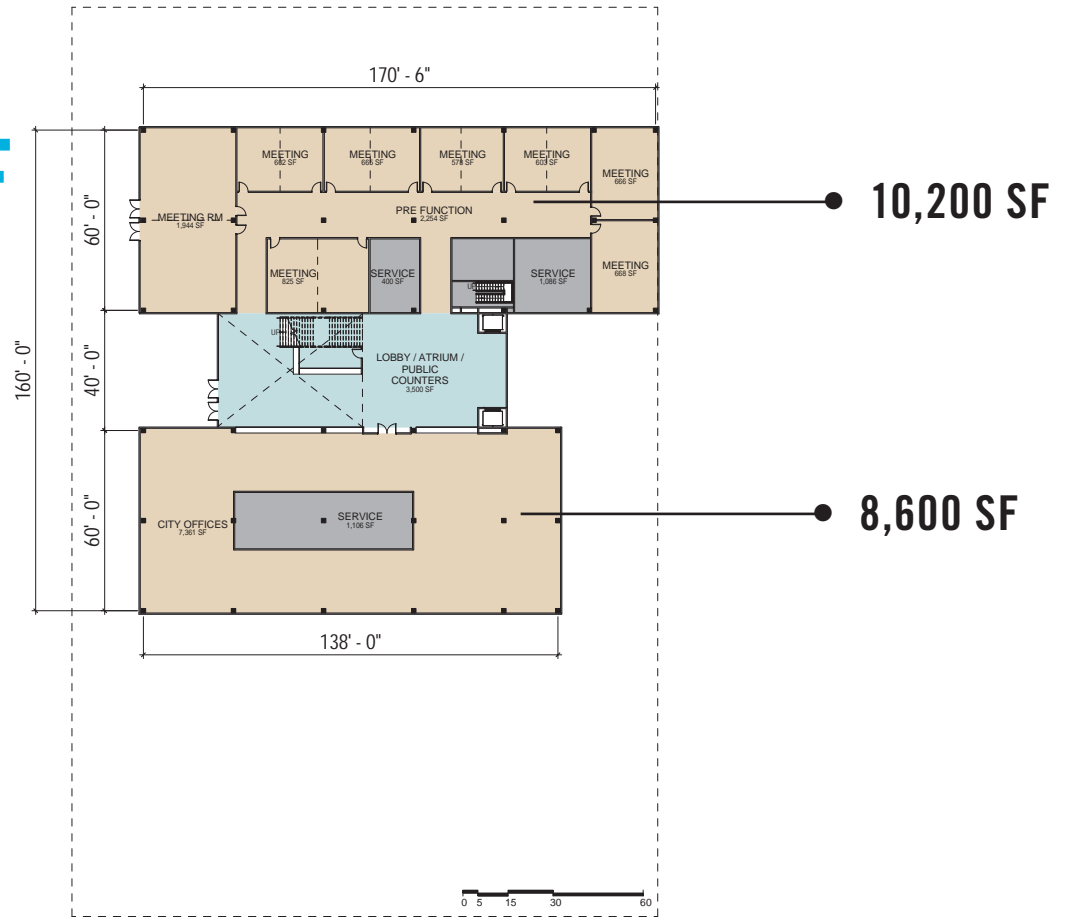

FIRST FLOOR PLAN

CIVIC CENTER MASTER PLAN

NEW CITY HALL OPTION 2: 40K GSF

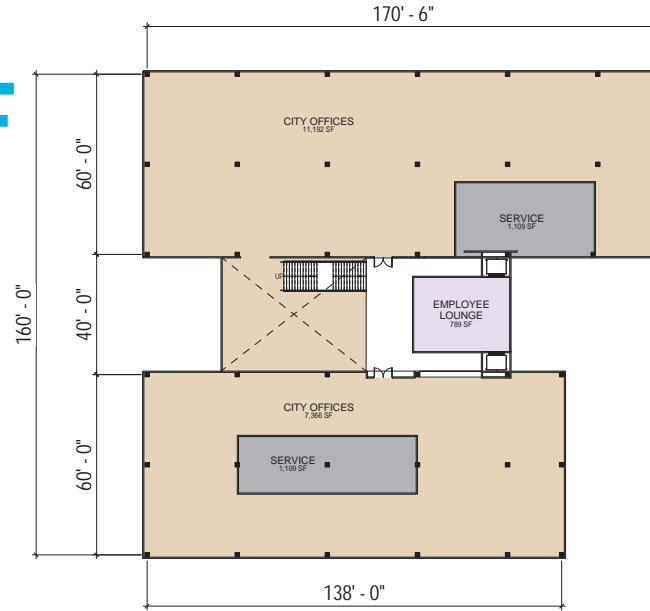

SECOND FLOOR PLAN

CIVIC CENTER MASTER PLAN

NEW CITY HALL OPTION 2: 40K GSF

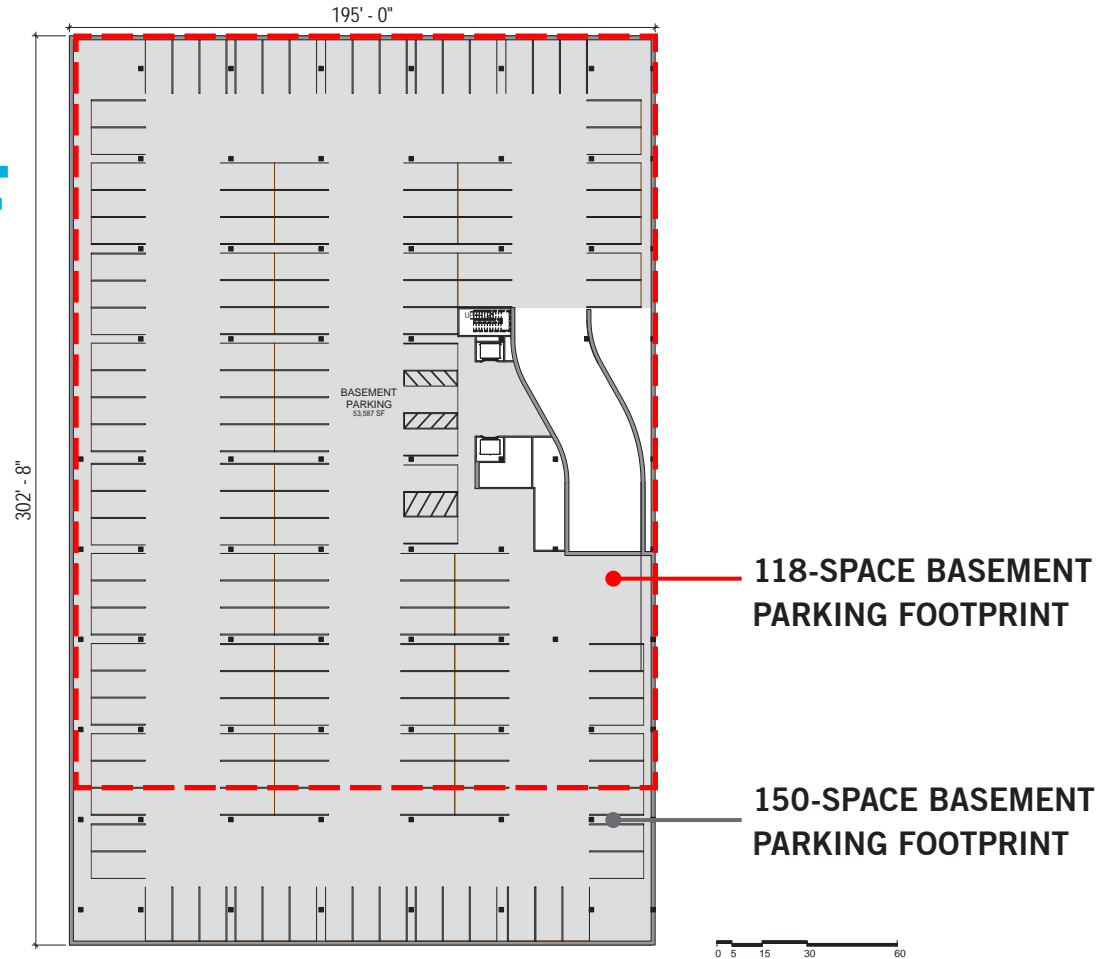

BASEMENT PARKING PLAN

CIVIC CENTER MASTER PLAN

NEW CITY HALL OPTION 2: 40K GSF

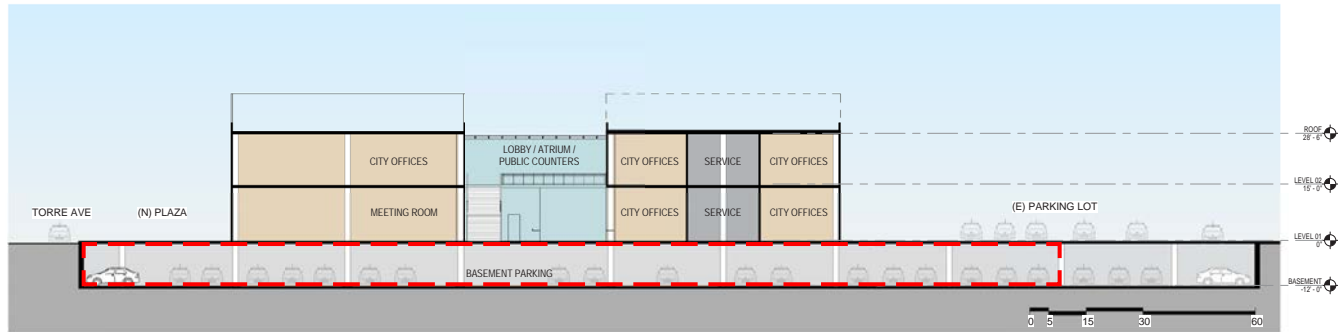

SECTION

LIBRARY EXPANSION

EXPANSION OPPORTUNITIES

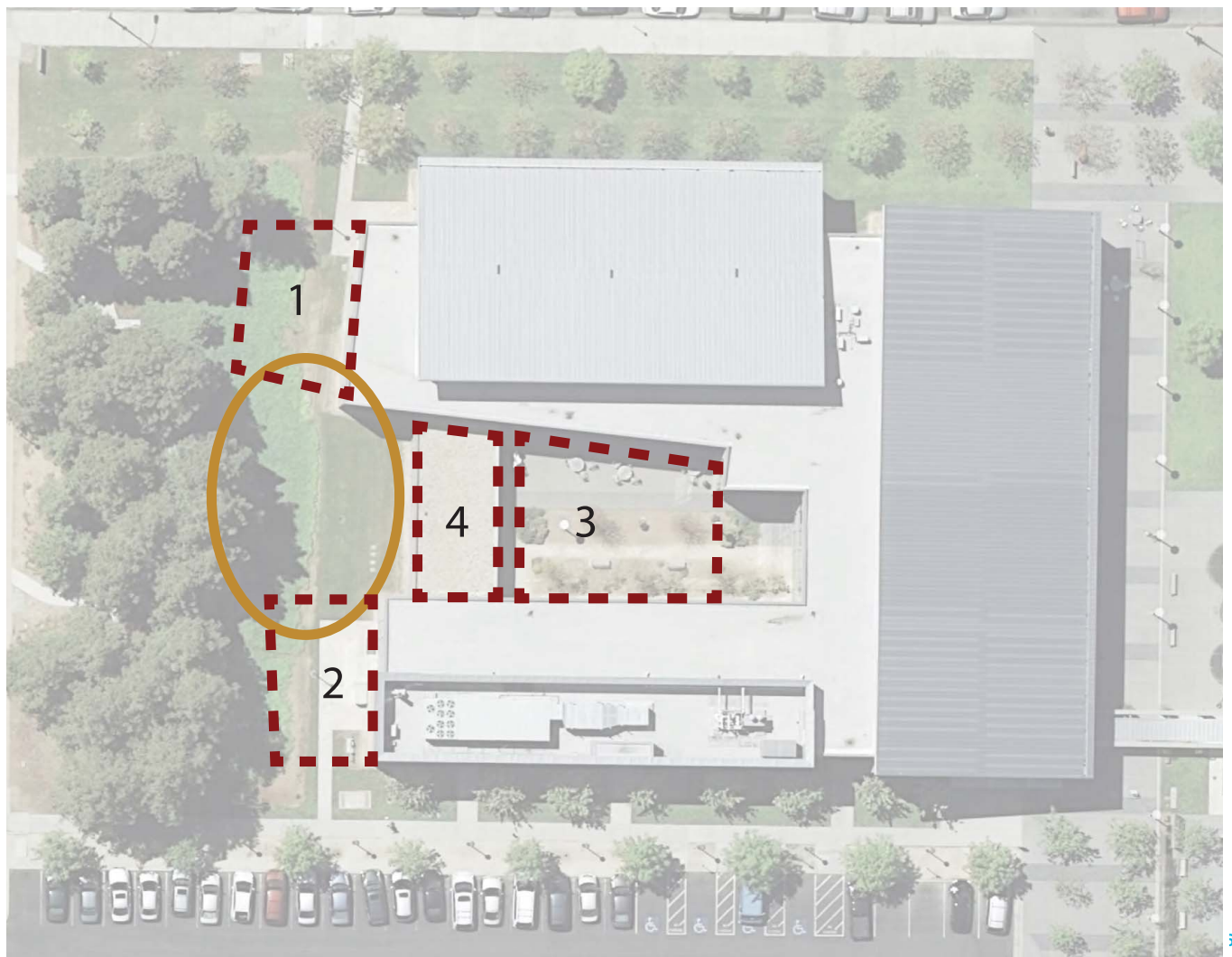

OPTION 1 WEST WING EXPANSION

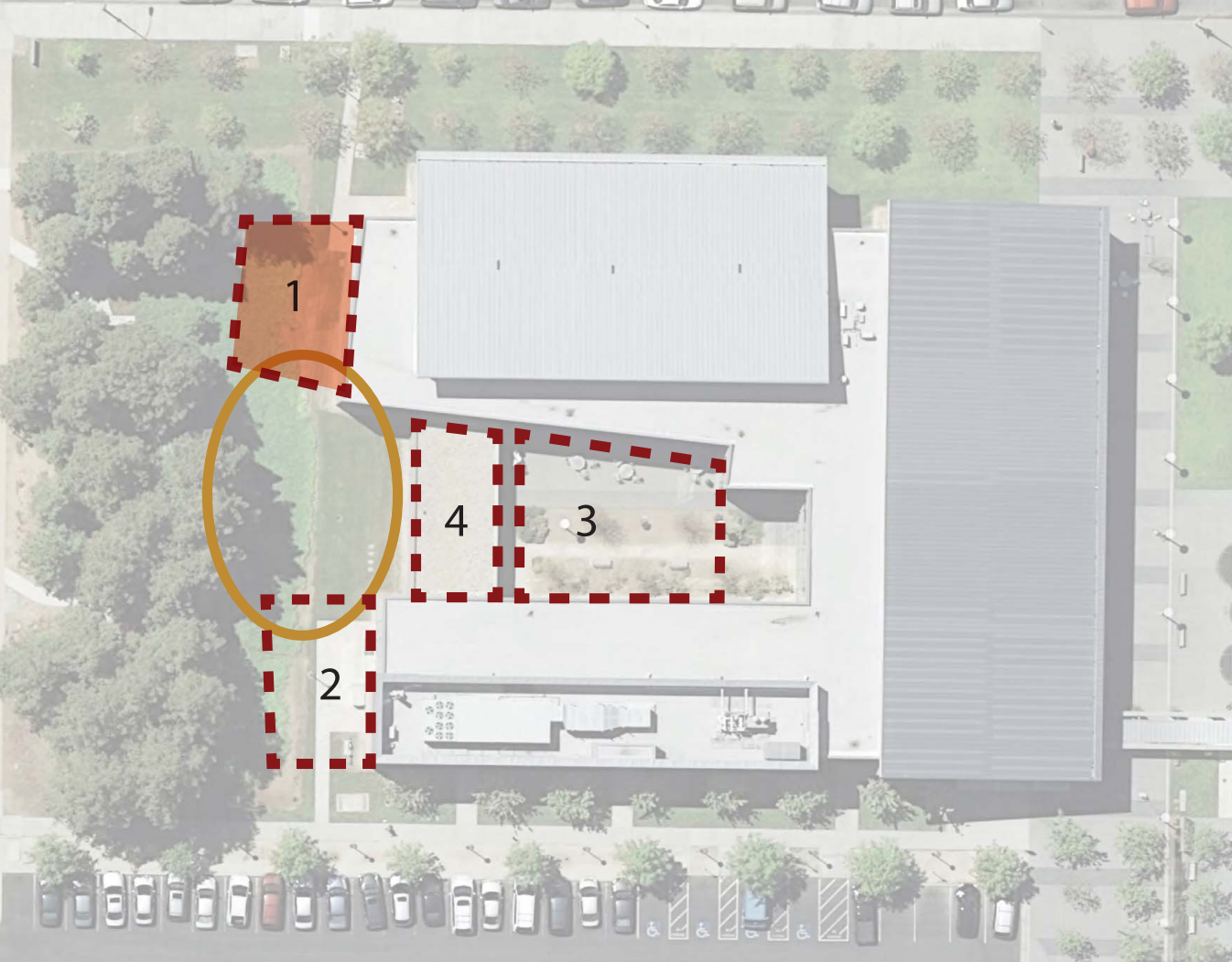

**EXPANSION
OPPORTUNITIES**

CIVIC CENTER MASTER PLAN

OPTION 1 WEST WING EXPANSION

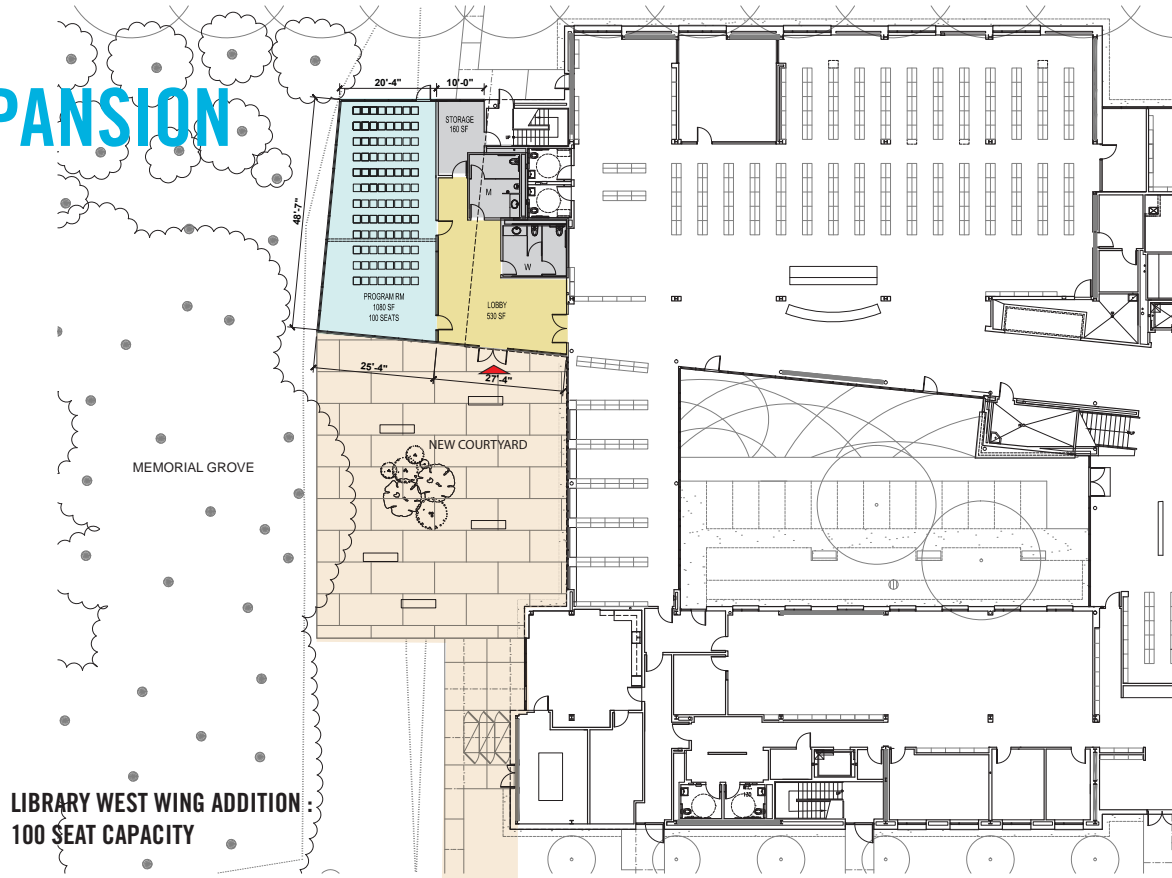

LIBRARY WEST WING ADDITION:
100 SEAT CAPACITY

CIVIC CENTER MASTER PLAN

OPTION 1 WEST WING EXPANSION

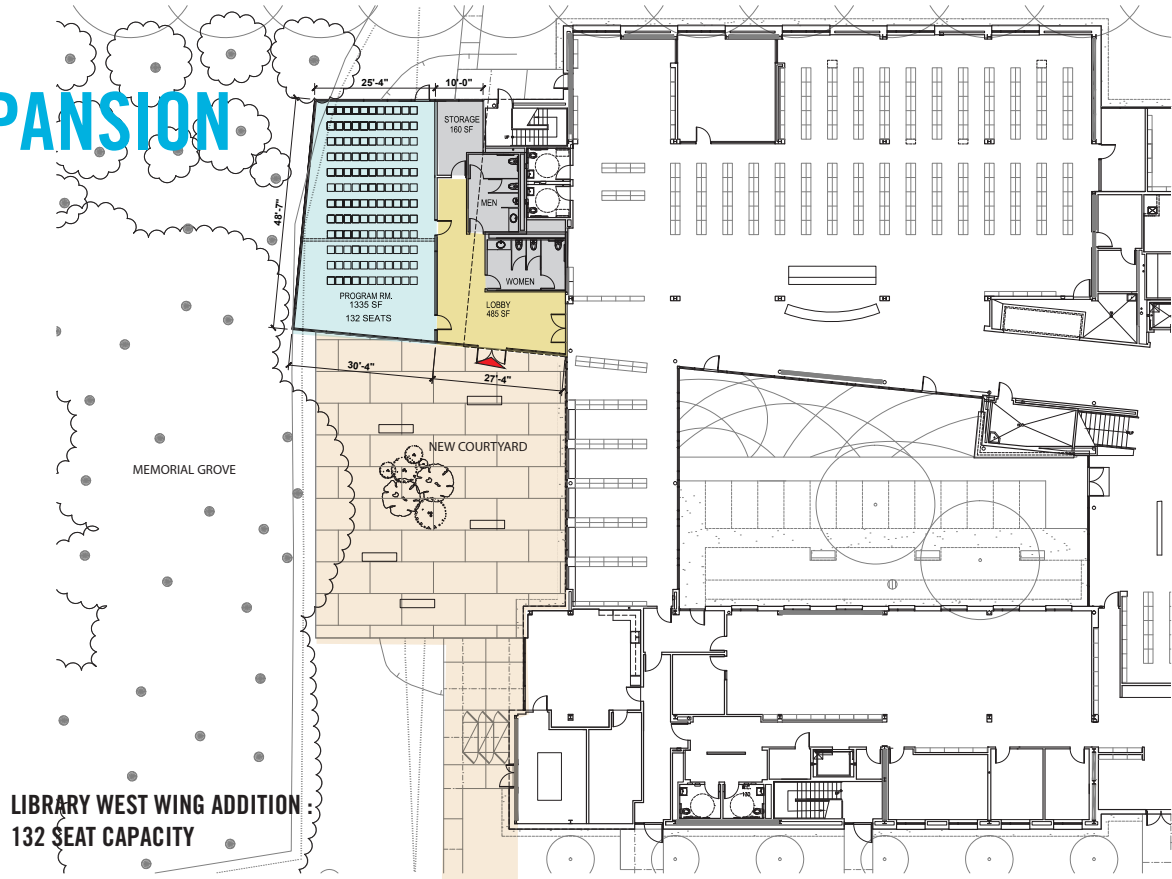

**LIBRARY WEST WING ADDITION:
132 SEAT CAPACITY**

OPTION 1 WEST WING EXPANSION



December 11, 2014



OPTION 1 WEST WING EXPANSION



December 11, 2014



OPTION 1 WEST WING EXPANSION



December 11, 2014



CIVIC CENTER MASTER PLAN

OPTION 1 WEST WING EXPANSION



OPTION 1: WEST WING EXPANSION



PROS:

1. Most Compact Addition
2. Cost Effective
3. Does Not affect the rest of Library Program

CONS:

1. Shape of Room is not ideal
2. Height of Room is limited by adjacency to Quiet Study
3. Disruption of Quiet Study During Construction
4. Far from Existing Mech Penthouse / Rooftop Equipment will be visible from Quiet study
5. Will Impact Memorial Grove Trees
6. Loss of Existing Story Room
7. 130 Capacity will impact more trees

OPTION 2 EAST WING EXPANSION

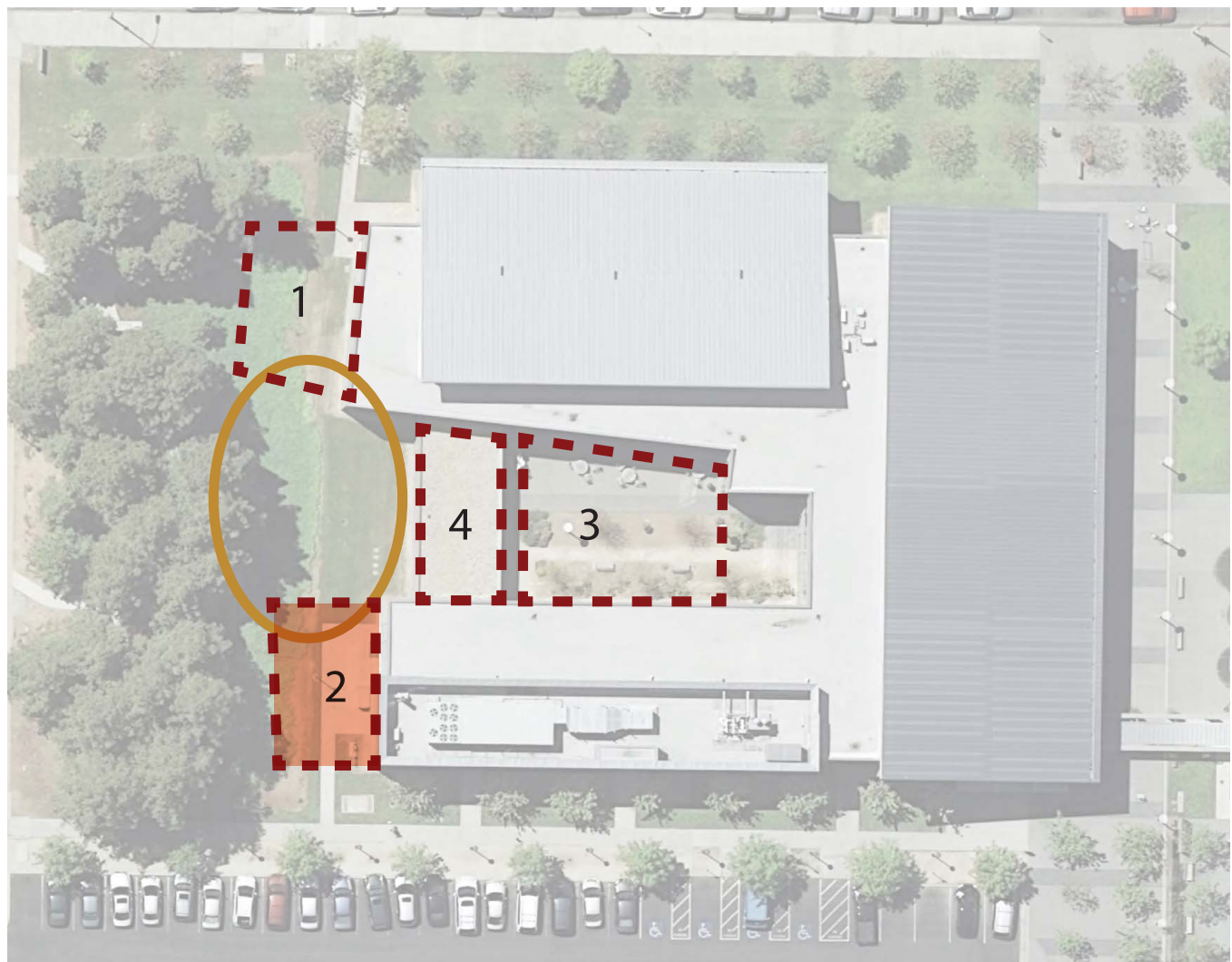

**EXPANSION
OPPORTUNITIES**

CIVIC CENTER MASTER PLAN

OPTION 2 EAST WING EXPANSION

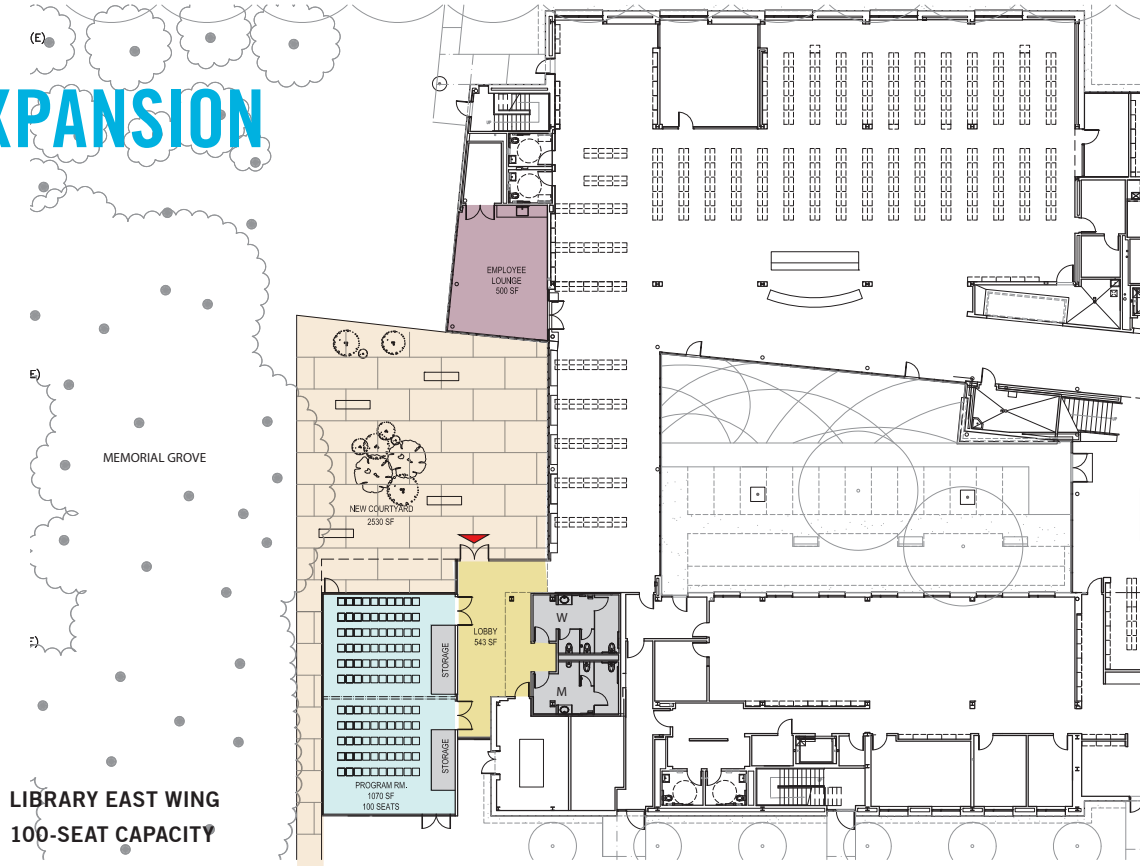

CIVIC CENTER MASTER PLAN

OPTION 2 EAST WING EXPANSION

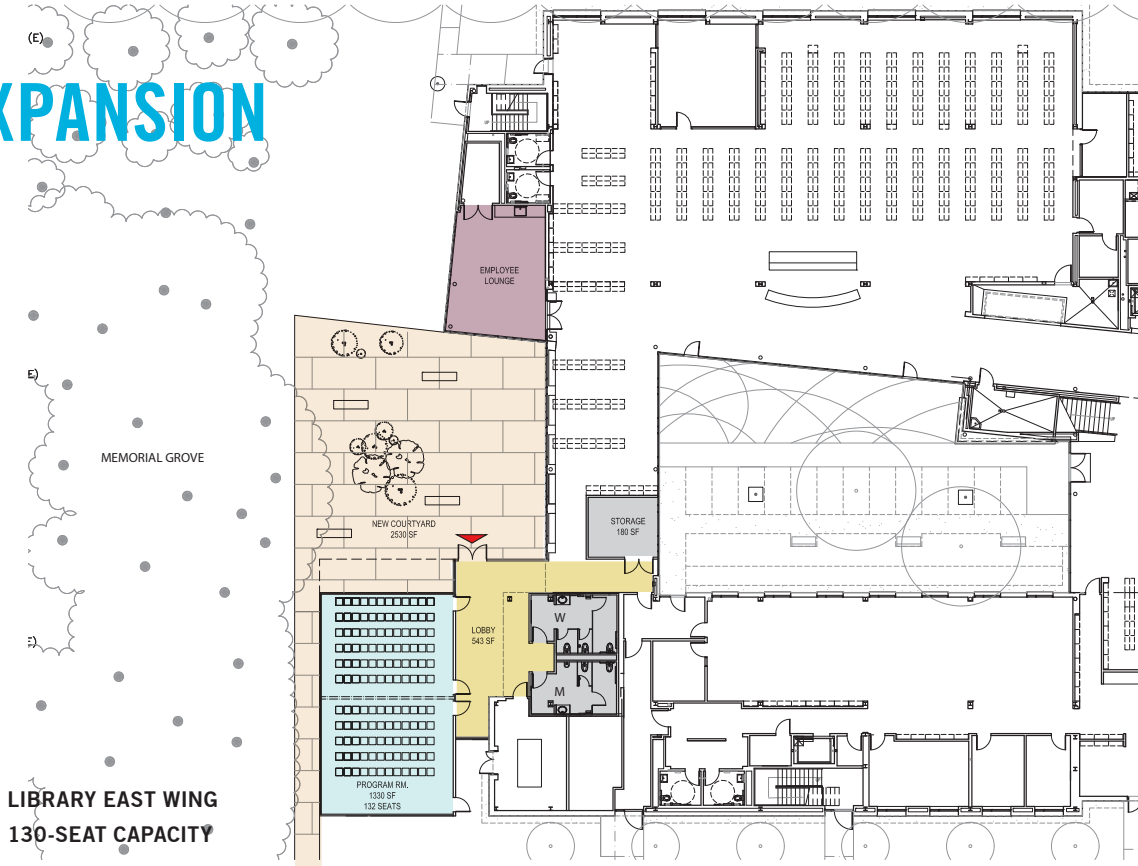

**LIBRARY EAST WING
130-SEAT CAPACITY**

OPTION 2 EAST WING EXPANSION



December 11, 2014



OPTION 2 EAST WING EXPANSION



December 11, 2014



OPTION 2 EAST WING EXPANSION



December 11, 2014



OPTION 2 EAST WING EXPANSION



December 11, 2014



OPTION 2 EAST WING EXPANSION



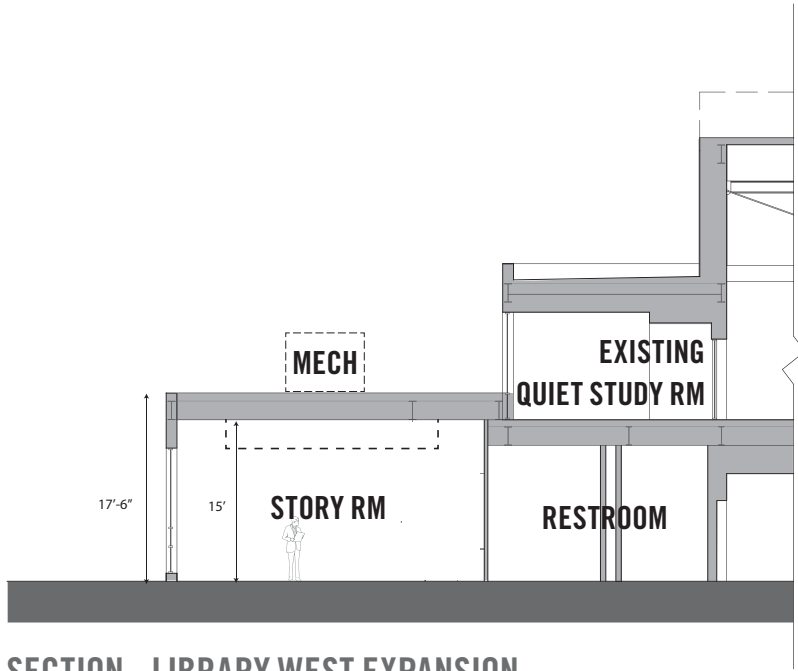

SECTION - LIBRARY WEST EXPANSION

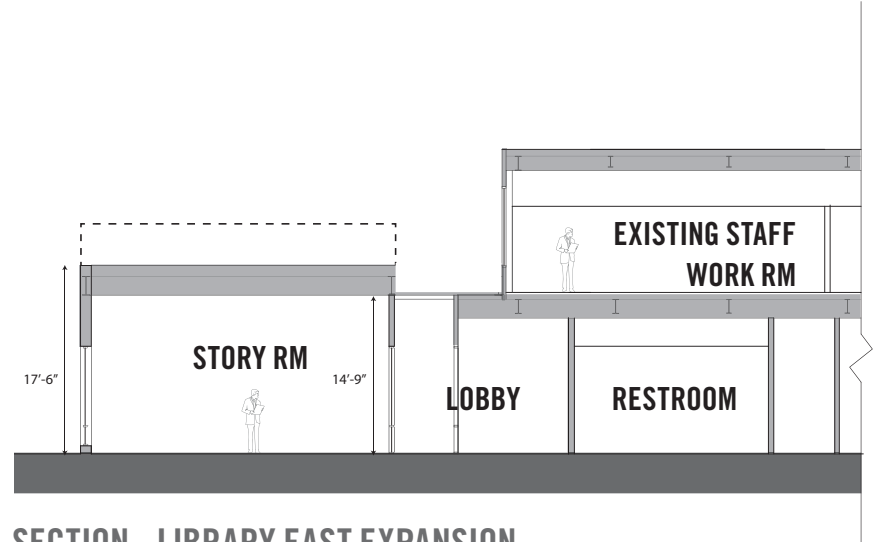

SECTION - LIBRARY EAST EXPANSION

OPTION 2: EAST WING EXPANSION



PROS:

1. Compact Addition
2. Cost Effective
3. Ideal / Flexible Room Shape
4. Ideal Ceiling Heights Achievable
5. Adjacent to Existing Mechanical Equipment / Penthouse
6. Minimal Impact to Memorial Grove Trees
7. Possible retention of Existing Story Room
8. Minimum Disruption of Library Operations
9. Can Accomodate 130 seats with minimum impact to Memorial Grove
10. Adjacent to Existing Parking (Easy Visibility)

CONS:

1. Employee Breakroom requires relocation (Cost)
2. Some Library Stacks will be affected
3. Some impact to Memorial Grove Trees

OPTION 3 COURTYARD INFILL

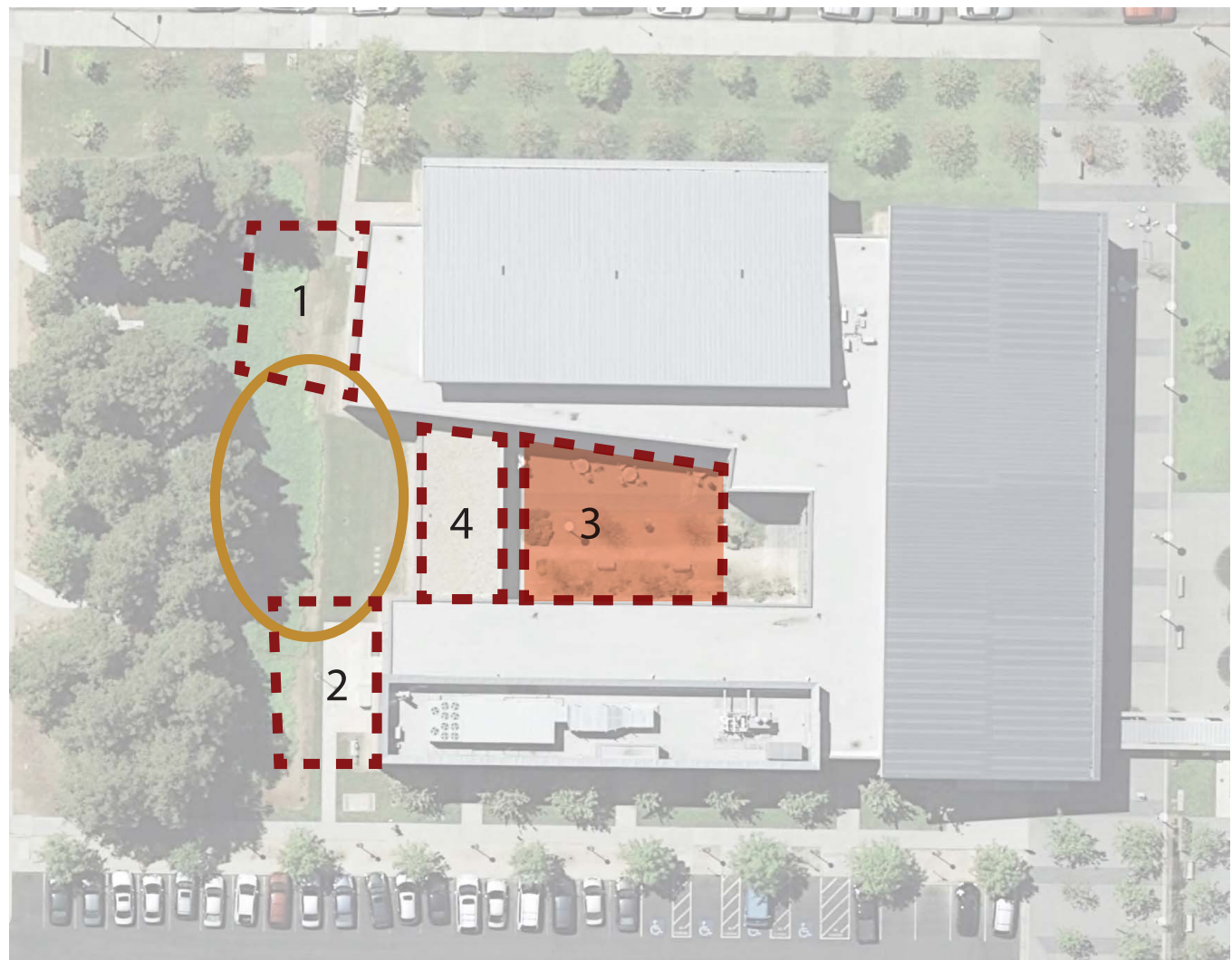

**EXPANSION
OPPORTUNITIES**

CIVIC CENTER MASTER PLAN

OPTION 3 COURTYARD INFILL

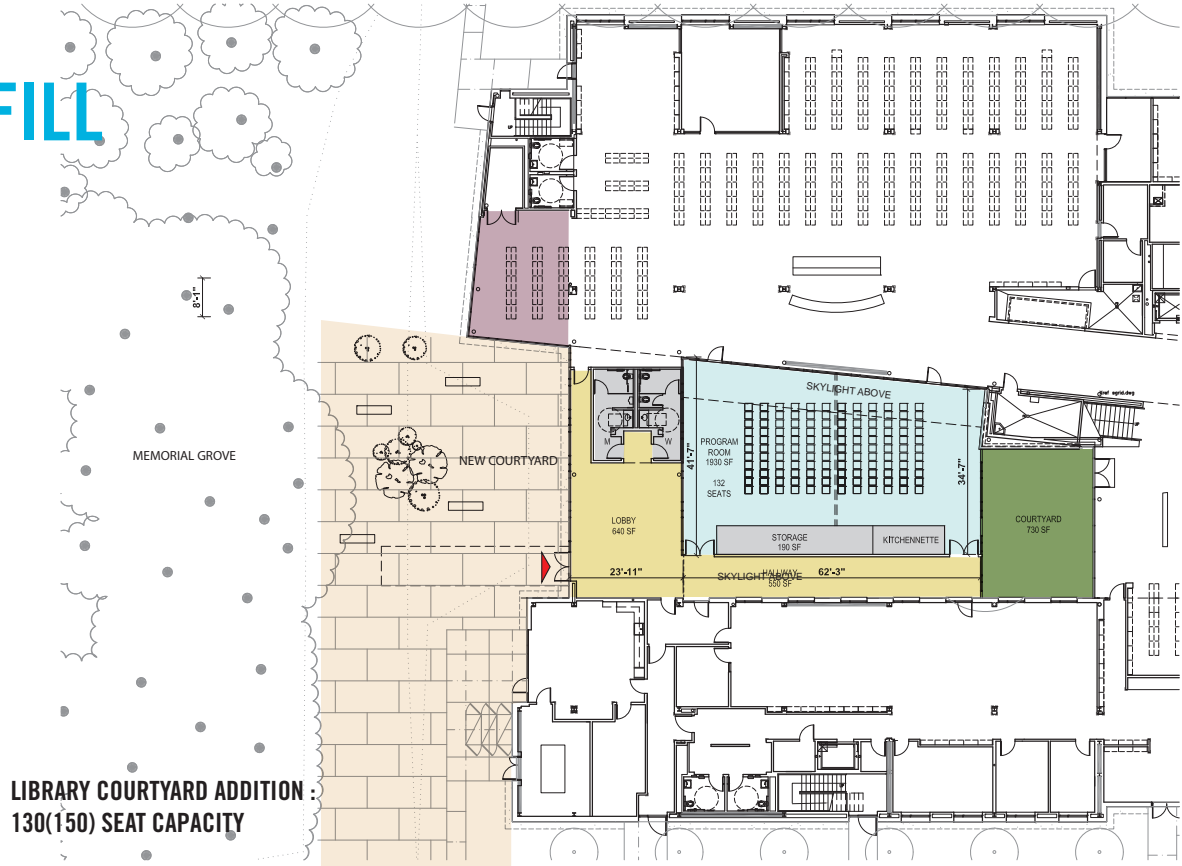

OPTION 3 COURTYARD INFILL



December 11, 2014



OPTION 3 COURTYARD INFILL



December 11, 2014



OPTION 3 COURTYARD INFILL



OPTION 3: COURTYARD INFILL



PROS:

1. Ideal Ceiling Heights Achievable
2. No Impact to Memorial Grove Trees
3. Can Accomodate 130-150 seats

CONS:

1. Large Addition (Cost + Flexibility)
2. Daylight to library and Employee Office areas will be greatly compromised
3. May greatly impact library functions during construction
4. Many Library Stacks need relocation
5. Loss of Existing Story Room
6. Loss of 80% of the Courtyard
7. Wayfinding can be a challenge (past library hours)
8. No Views to the outside

OPTION 4 “PERCH” ADDITION

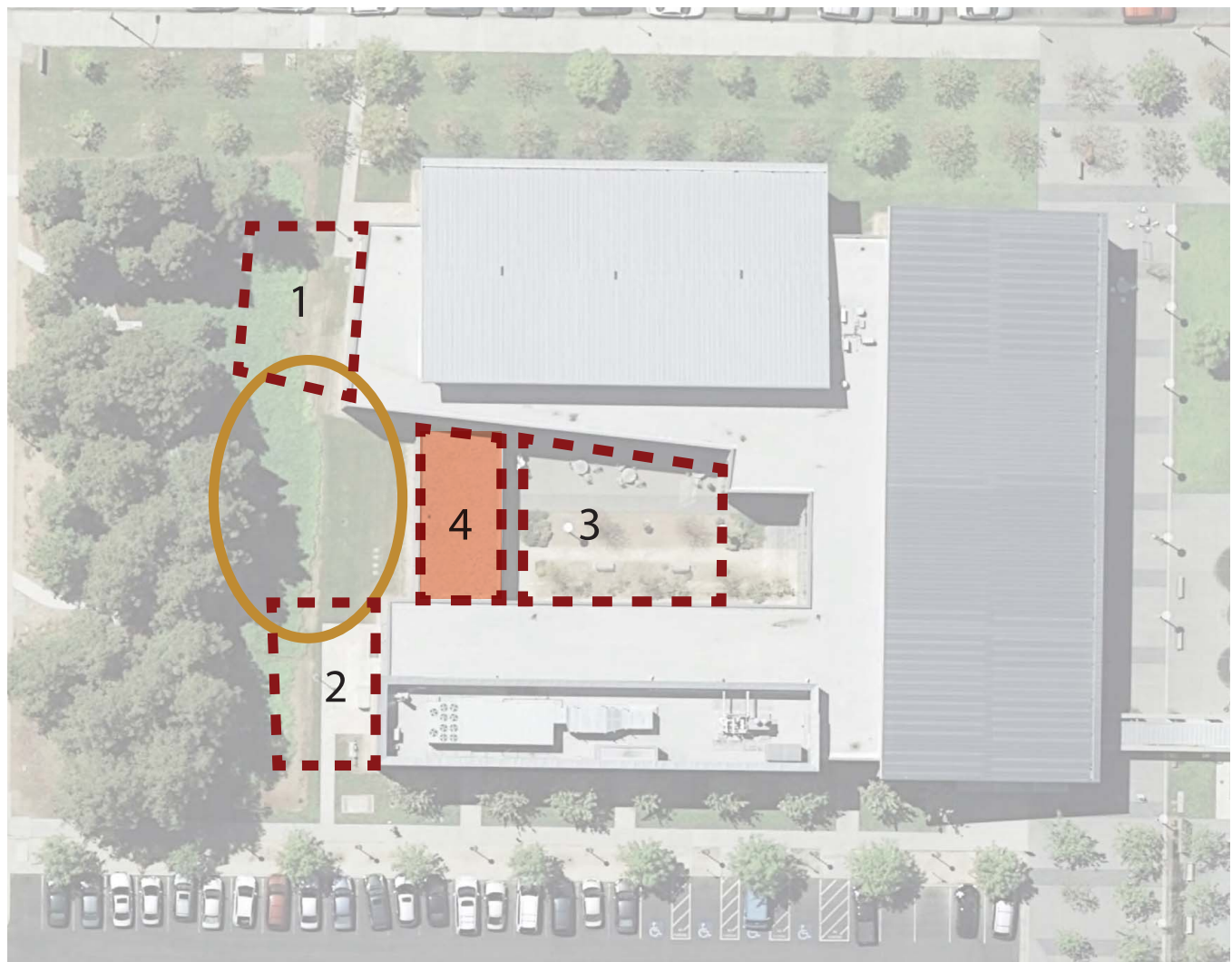

**EXPANSION
OPPORTUNITIES**

CIVIC CENTER MASTER PLAN

OPTION 4 "PERCH" ADDITION

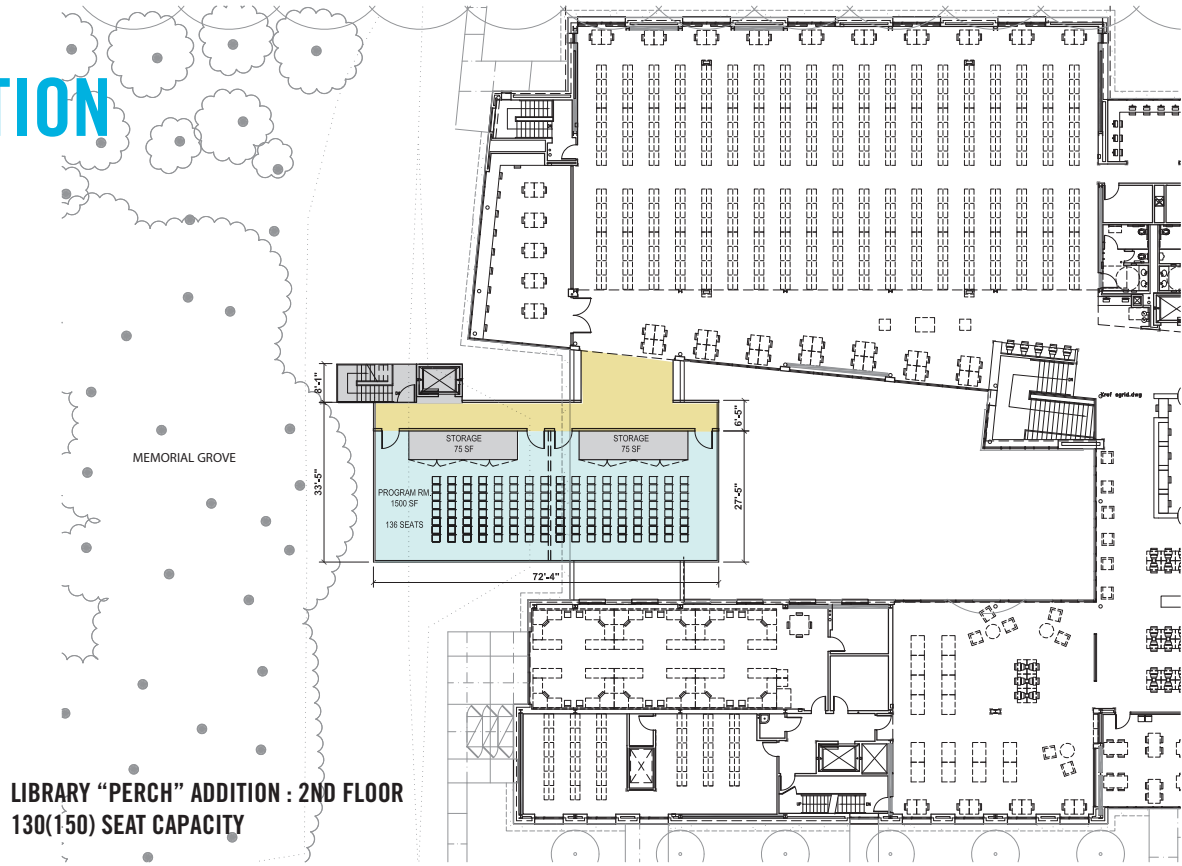

LIBRARY "PERCH" ADDITION : 2ND FLOOR
130(150) SEAT CAPACITY

OPTION 4 “PERCH” ADDITION



December 11, 2014



OPTION 4 “PERCH” ADDITION



December 11, 2014



OPTION 4 “PERCH” ADDITION



OPTION 4 “PERCH” ADDITION



OPTION 4 “PERCH” ADDITION



December 11, 2014



OPTION 4 "PERCH" ADDITION

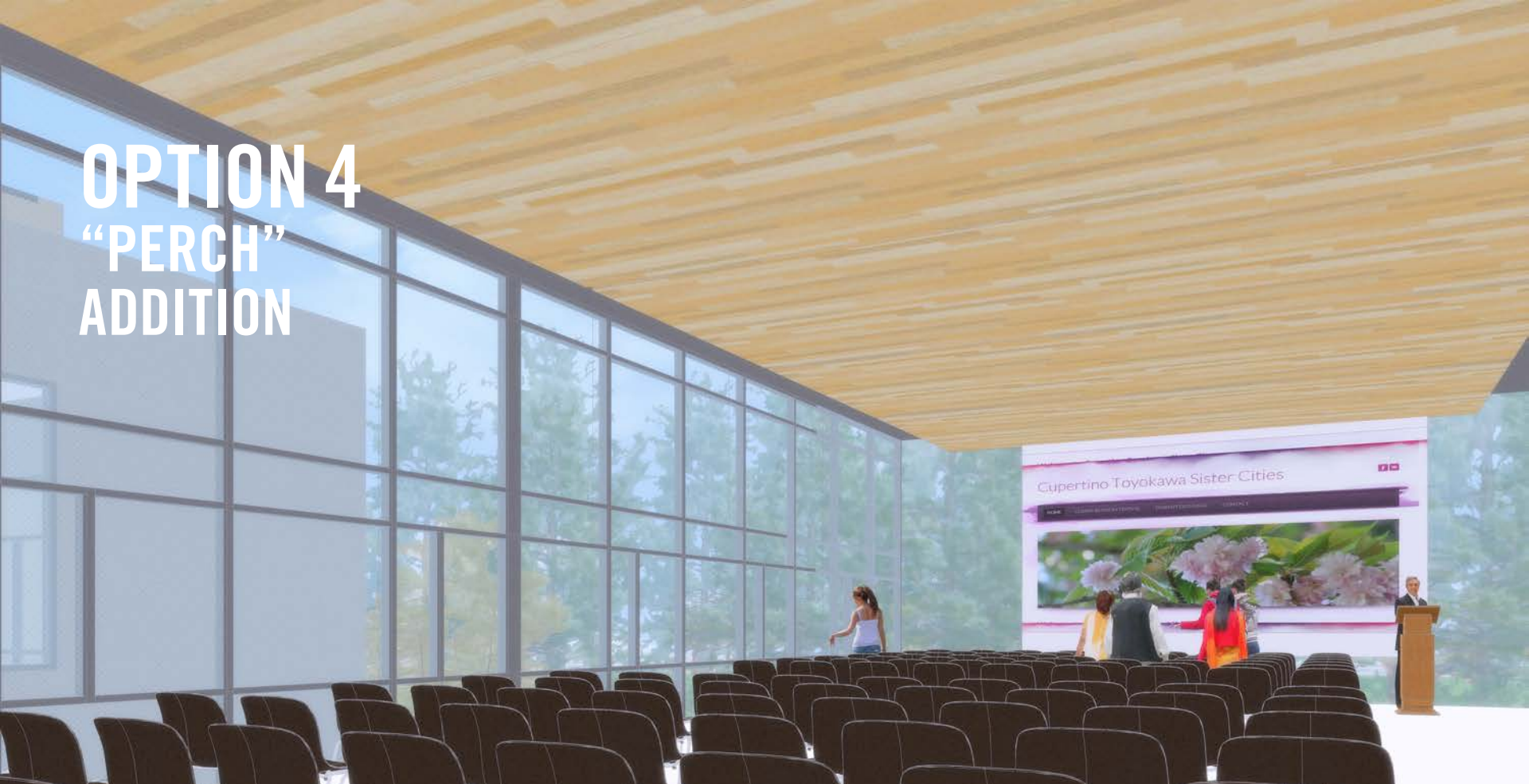

CIVIC CENTER MASTER PLAN

OPTION 4: “PERCH” ADDITION



PROS:

1. Ideal Ceiling Heights Achievable
2. Room Shape is ideal / flexible
3. No Impact to Memorial Grove Trees
4. Easy Visibility from Parking
5. Adjacent to existing Mechanical Penthouse
6. More Roof Surface for Photovoltaics
7. Minimum impact to permeable surfaces
8. Optimal views to outside
9. Retention of Existing Story Room
10. Minimal disruption of Library during construction (no relocation)

CONS:

1. Cost
2. Daylight to childrens stacks may be affected

CIVIC CENTER MASTER PLAN

EXISTING TREES IMPACTED



CIVIC CENTER MASTER PLAN

IMPACTED AREAS

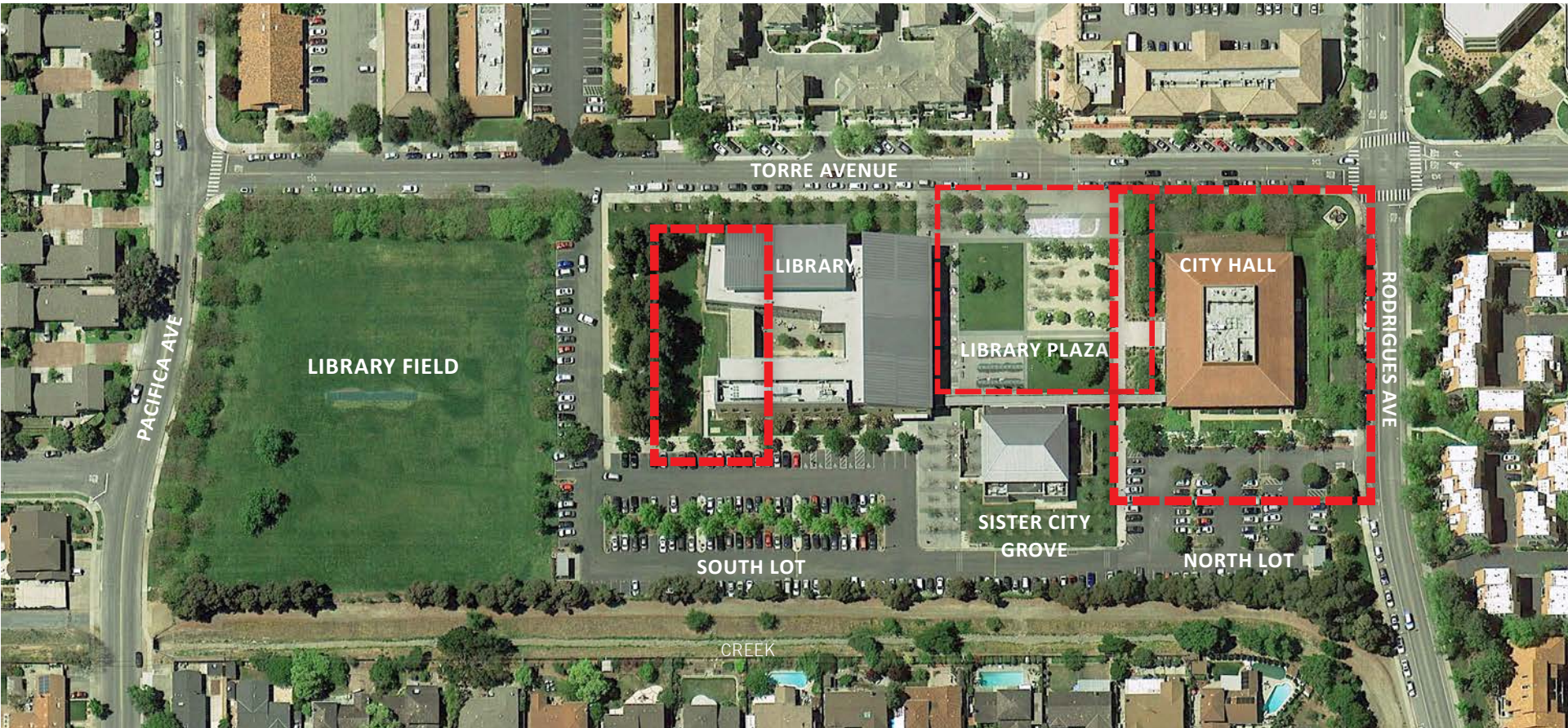

CIVIC CENTER MASTER PLAN

PRECEDENT IMAGES

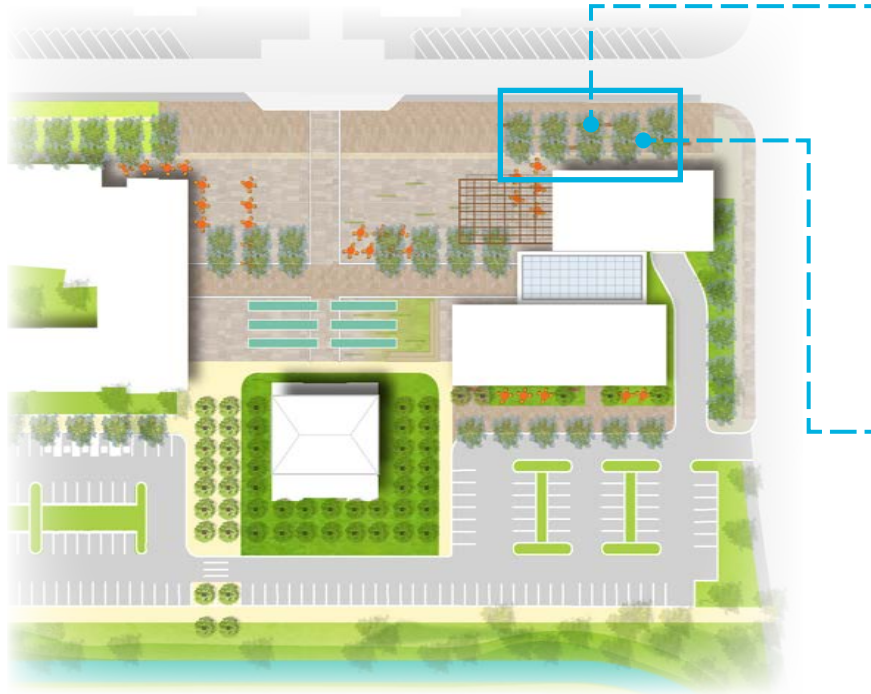

CIVIC CENTER MASTER PLAN

PRECEDENT IMAGES

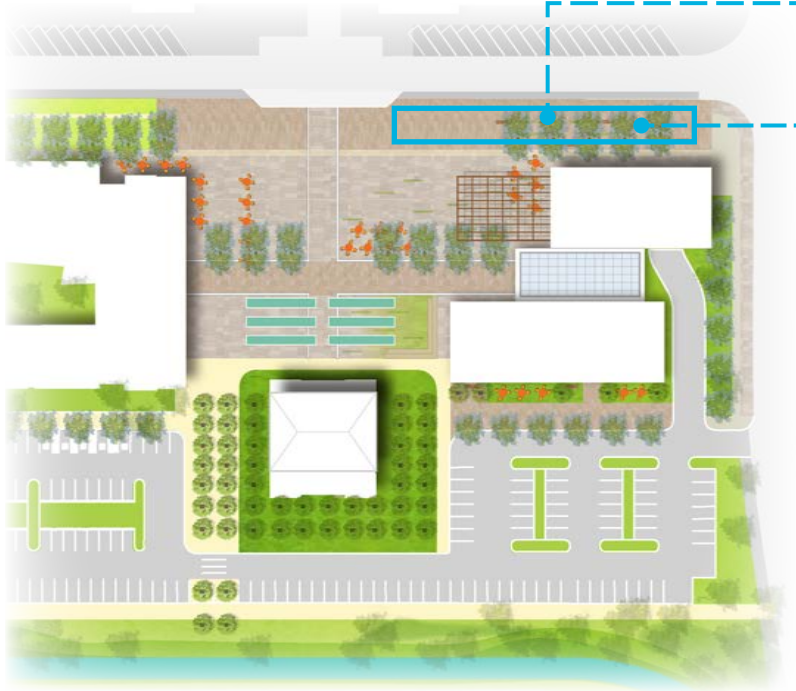

CIVIC CENTER MASTER PLAN

PRECEDENT IMAGES



CIVIC CENTER MASTER PLAN PRECEDENT IMAGES

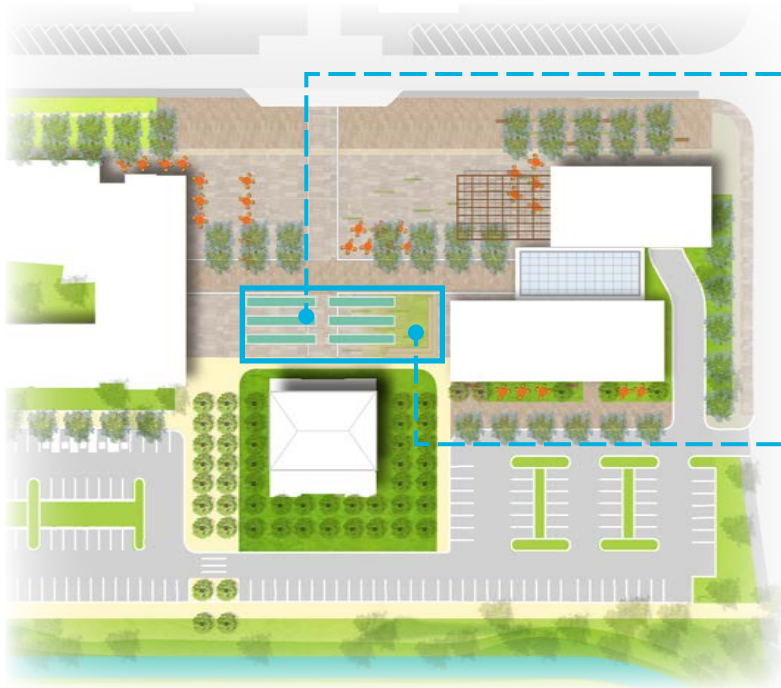

CIVIC CENTER MASTER PLAN

PRECEDENT IMAGES

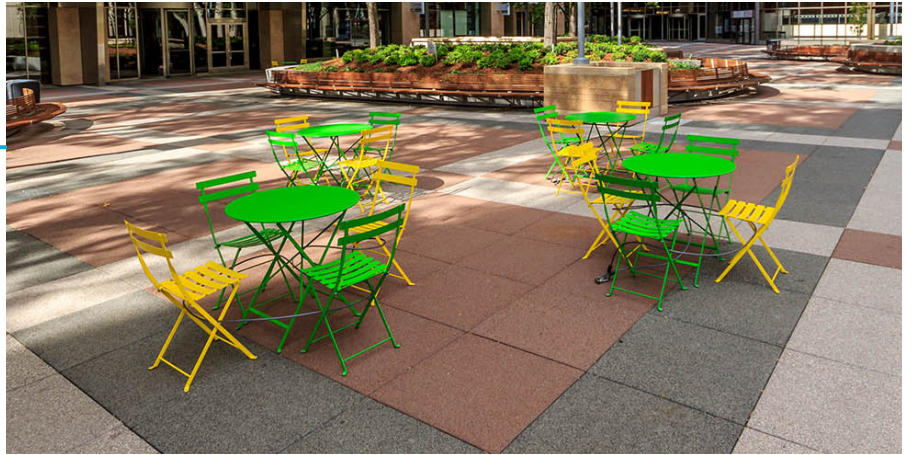
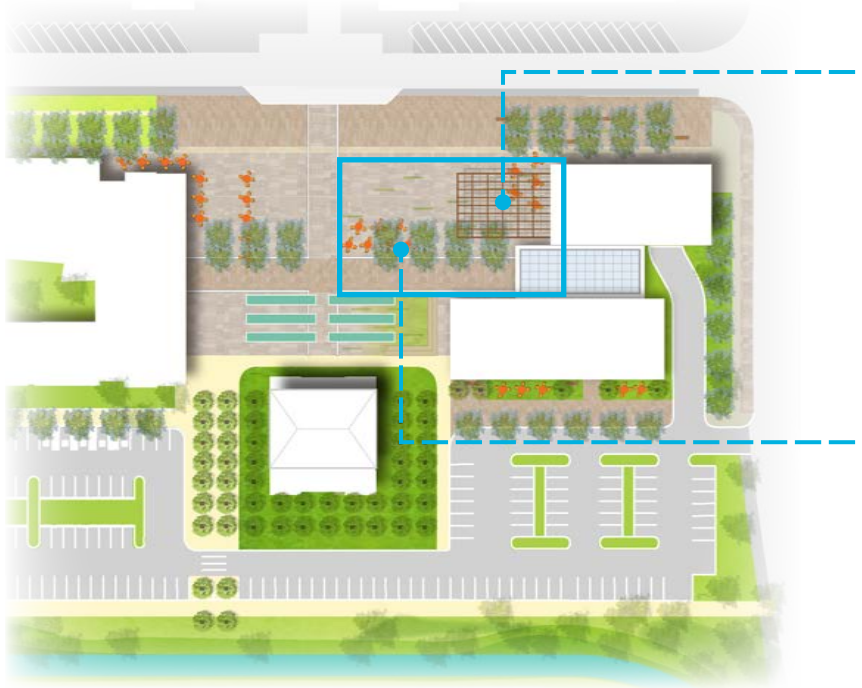

CIVIC CENTER MASTER PLAN

PRECEDENT IMAGES

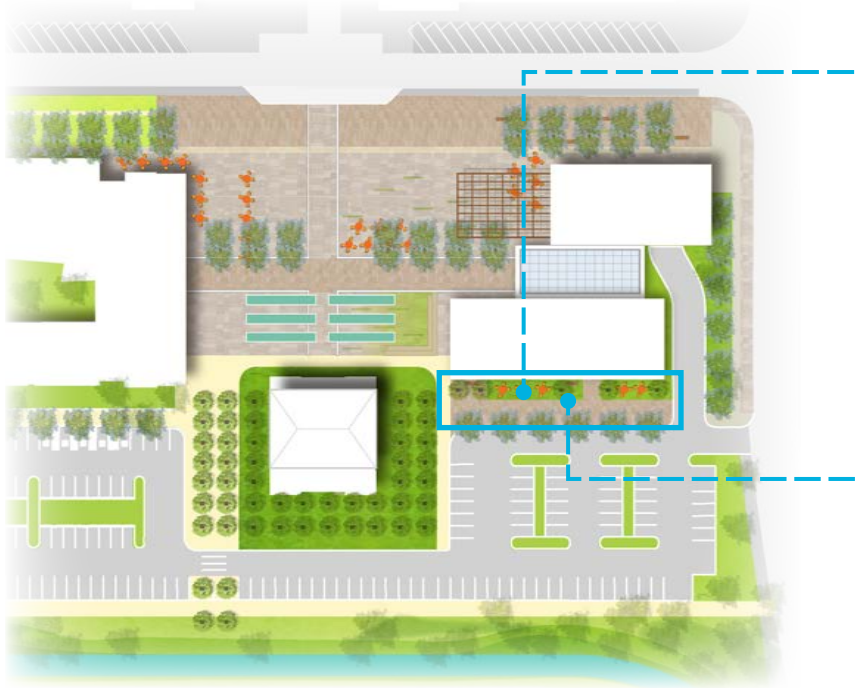

APPENDIX A - 16

Cupertino City Hall Cost Estimates (TBD, June 15, 2015)

- New City Hall 40,000 sf
- New City Hall 35,000 sf
- New City Hall 30,000 sf

Cupertino City Hall

Cupertino ,CA

June 15, 2015

OPTION 40,000SF

New Construction



tbd consultants

111 Pine Street, Suite 1315
San Francisco, CA 94111
415.981.9430 phone (main)
415.981.9434 facsimile
www.tbdconsultants.com

Prepared for:

Perkins Will
2 Bryant Street
San Francisco, CA

TABLE OF CONTENTS

OPTION 40,000SF

CONTENTS

PAGE No.

Basis of Estimate

1

Key Criteria - Areas

4

Overall Summary

5

New Construction

Cost Summary

6

Detailed Estimate

7

PROJECT DESCRIPTION

The project involves the new construction of a two story building sitting on top of a one level parking structure podium
(parking structure costs taken with the parking costs)

REFERENCE DOCUMENTATIONDocuments:

Civic Center Masterplan Document

Dated 12/11/14

MEETINGS

Meeting / ongoing discussions with Architect / design team

BASIS FOR PRICING

This estimate reflects the fair construction value for this project and should not be construed as a prediction of low bid. Prices are based on local prevailing wage construction costs at the time the estimate was prepared. Pricing assumes a procurement process with competitive bidding for all sub-trades of the construction work, which is to mean a minimum of 3 bids for all subcontractors and materials/equipment suppliers. If fewer bids are solicited or received, prices can be expected to be higher.

Subcontractor's markups have been included in each line item unit price. Markups cover the cost of field overhead, home office overhead and subcontractor's profit. Subcontractor's markups typically range from 15% to 25% of the unit price depending on market conditions.

General Contractor's/Construction Manager's Site Requirement costs are calculated on a percentage basis. General Contractor's/Construction Manager's Jobsite Management costs are also calculated on a percentage

General Contractor's/Construction Manager's overhead and fees are based on a percentage of the total direct costs plus general conditions, and covers the contractor's bond, insurance, site office overheads and profit.

BASIS OF ESTIMATE

OPTION 40,000SF

Unless identified otherwise, the cost of such items as overtime, shift premiums and construction phasing are not included in the line item unit price.

This cost estimate is based on standard industry practice, professional experience and knowledge of the local construction market costs. TBD Consultants have no control over the material and labor costs, contractors methods of establishing prices or the market and bidding conditions at the time of bid. Therefore TBD Consultants do not guarantee that the bids received will not vary from this cost estimate.

CONTINGENCY

Design Contingency **15%**

The Design Contingency is carried to cover scope that lacks definition and scope that is *anticipated* to be added to the Design. As the Design becomes more complete the Design Contingency will reduce.

Construction Contingency **10%**

The Construction Contingency is carried to cover the unforeseen during construction execution and Risks that do not currently have mitigation plans. As Risks are mitigated, Construction Contingency can be reduce, but should not be eliminated.

A Market Conditions Factor has not been included to reflect the current bidding climate where we should expect multiple bids for each trade. An owners contingency has not been included in this construction cost estimate, but it is advised that the owner carry additional contingency to cover scope change, claims and delays.

ESCALATION

Escalation has been included in the estimate -- see summary

EXCLUSIONS from CONSTRUCTION COST

- Land acquisition, feasibility, and financing costs
- All Owner soft costs
- All professional fees and insurance
- Construction Manager Agency Costs
- Site or existing condition survey investigation costs, including determination of subsoil conditions
- Hazardous materials inspection costs, or accommodations in construction for hazardous materials.
- Overtime, 2nd shift and lost productivity premiums - except where specifically identified
- Construction or occupancy phasing (current assumption is a single construction phase in a vacated building)
- Owners Construction Contingency for scope changes and market conditions at time of bid
- Permits

ITEMS THAT MAY AFFECT THIS ESTIMATE

Such items include, but are not limited to the following:

- Modifications to the scope of work subsequent to the preparation of this estimate
- Unforeseen existing conditions
- Compression of planned construction schedule (current assumption is approx. 6 months+ duration)
- Special requirements for site access, off-hour work or phasing activities
- Restrictive technical specifications, excessive contract or non-competitive bid conditions
- Sole source specifications for materials, products or equipment
- Bid approvals delayed beyond the anticipated project schedule

KEY CRITERIA

OPTION 40,000SF

AREA TABULATION

New Construction

Location	Enclosed	Perimeter	Height	Area	Comment
First Floor	SF 20,000	700	20.00	SF 14,000	
Second floor	20,000	700	15.00	10,500	
Third floor		0			
Subtotal	40,000 SF	1,400 SF	35.00 LF	24,500.00	
Covered Area @ 50%	500 SF				Allow
TOTAL	40,500 SF				

OVERALL SUMMARY

OPTION 40,000SF

	GROSS FLOOR AREA	COST (\$/SF)	COST (\$'s)
New Construction	40,500	\$728	\$29,489,452
Moving cost			\$200,000
Rental of interim space for 18 months			
22,500 SF at \$5/SF per month	24 months		\$2,700,000
EOC Buildig ON site			NA
Hazmat abatement	Allowance		\$225,000
Soft costs	25% of direct cost		\$7,372,363
FFE	All new	35/SF	\$1,417,500
Construction Contingency	10% or direct cost		\$2,948,945
TOTAL including soft and hard cost			\$44,353,260

UNIFORMAT II SUMMARY

Gross Square Feet: 40,500

New Construction

OPTION 40,000SF

SECTION	%	\$	\$ / SF	COMMENTS
10 FOUNDATIONS	2.8%	520,000	12.84	
20 BASEMENT CONSTRUCTION	1.1%	200,000	4.94	
A SUBSTRUCTURE	3.9%	720,000	17.78	
10 SUPERSTRUCTURE	10.8%	2,023,050	49.95	
20 EXTERIOR CLOSURE	17.1%	3,194,750	78.88	
30 ROOFING	11.0%	2,055,500	50.75	
B SHELL	38.9%	7,273,300	179.59	
10 INTERIOR CONSTRUCTION	10.8%	2,025,000	50.00	
20 STAIRS	0.6%	120,000	2.96	
30 INTERIOR FINISHES	8.1%	1,515,000	37.41	
C INTERIORS	19.6%	3,660,000	90.37	
10 CONVEYING	1.1%	200,000	4.94	
20 PLUMBING	2.6%	486,000	12.00	
30 HVAC	13.2%	2,470,500	61.00	
40 FIRE PROTECTION	1.2%	222,750	5.50	
50 ELECTRICAL	15.8%	2,959,450	73.07	
D SERVICES	33.9%	6,338,700	156.51	
10 EQUIPMENT	0.4%	75,000	1.85	
20 FURNISHINGS	1.3%	250,000	6.17	
E EQUIPMENT + FURNISHINGS	1.7%	325,000	8.02	
10 SPECIAL CONSTRUCTION				
20 SELECTIVE BUILDING DEMOLITION				
F SPECIAL CONSTRUCTION + DEMOLITION				
10 SITE PREPARATION				
20 SITE IMPROVEMENTS	0.5%	100,000	2.47	
30 SITE MECHANICAL UTILITIES	0.8%	150,000	3.70	
40 SITE ELECTRICAL UTILITIES	0.6%	120,000	2.96	
50 OTHER SITE CONSTRUCTION				
G BUILDING SITEWORK	2.0%	370,000	9.14	
DIRECT COSTS	100%	18,687,000	461.41	
SITE REQUIREMENTS	3.0%	560,610	13.84	
JOBSITE MANAGEMENT	8.0%	1,494,960	36.91	
ESTIMATE SUB-TOTAL		20,742,570	512.16	
INSURANCE + BONDING	2.5%	518,564	12.80	
FEE	5.0%	1,037,129	25.61	
ESTIMATE SUB-TOTAL		22,298,263	550.57	
DESIGN CONTINGENCY	15.0%	3,344,739	82.59	
CONSTRUCTION CONTINGENCY	N/A			Owner to carry
ESTIMATE SUB-TOTAL		25,643,002	633.16	
ESCALATION 3 years to mid point	15.0%	3,846,450	94.97	
ESTIMATE TOTAL		\$ 29,489,452	728.13	total add-ons 57.81%

REF	DESCRIPTION	QUANTITY	UoM	UNIT RATE	TOTAL	COMMENTS
1						
2	FOUNDATIONS					
3						
4	Foundation allocation	20,000	SF	16.00	320,000	
5	(allocation of foundation costs and misc. items)					
6						
7	Special foundations		NA			
8						
9	Slab on grade -- topping slab	20,000	SF	10.00	200,000	Including curbs etc.
10						
11						
12	FOUNDATIONS				520,000	\$12.84 / SF
13						
14	BASEMENT CONSTRUCTION					
15						
16	Shear walls for elevators etc.	20,000	SF	10.00	200,000	Storage?
17						
18						
19	BASEMENT CONSTRUCTION				200,000	\$4.94 / SF
20						
21	SUPERSTRUCTURE					
22						
23	<u>Floor & Roof Construction</u>					
24						
25	<i>Steel construction</i>					
26						
27	Steel frame					
28	Structural steel moment frame	357	T	4,000.00	1,428,000	
29	Fireproofing		NA			
30	Metal deck					
31	Floor	20,000	SF	4.15	83,000	
32	Roof	20,000	SF	3.85	77,000	
33	Concrete fill to metal deck, reinforced	40,000	SF	6.15	246,000	
34	Slab edge closure		NA			incl above
35	Form openings in deck	1	LS	10,000.00	10,000	
36						
37	Spray fireproofing to u/side of decks		NA			
38	Curbs at plumbing walls etc	1	LS	4,000.00	4,000	
39						
40	Miscellaneous					
41						
42	Allow for miscellaneous structural supports	1	LS	25,000.00	25,000	Pads etc
43	Structural supports to parapet	1	LS	20,000.00	20,000	
44	Allow for miscellaneous metals	40,500	SF	2.50	101,250	
45	Fire stopping	1,600	LF	18.00	28,800	
46						
47						
48	SUPERSTRUCTURE				2,023,050	\$49.95 / SF
49						
50	EXTERIOR CLOSURE					
51						
52	Exterior Walls					
53						
54	Above grade ext skin	26,600	SF	90.00	2,394,000	
55	Windows curtain walling premium	4,000	SF	95.00	380,000	Premium
56						
57	Soffits	1	LS	100,000.00	100,000	
58	Fins and louvers	1	LS	200,000.00	200,000	
59						
60	Misc					
61	Caulking joints etc.	40,500	SF	1.50	60,750	

Cupertino City Hall
Cupertino, CA

NEW CONSTRUCTION

New Construction
Concept Development Phase

New Construction

OPTION 40,000SF

GSF :

40,500

REF	DESCRIPTION	QUANTITY	UoM	UNIT RATE	TOTAL	COMMENTS
62						
63	Exterior Doors					
64						
65	New doors	1	LS	60,000.00	60,000	
66						
67						
68	EXTERIOR CLOSURE				3,194,750	\$78.88 / SF
69						
70	ROOFING					
71						
72	Metal sloped roofing	12,000	SF	30.00	360,000	
73						
74	Flat roofing	9,000	SF	22.00	198,000	
75						
76	New mechanical pads on roof	1	LS	20,000.00	20,000	
77						
78	Roof screens	1	LS	75,000.00	75,000	
79	Skylights	1	Loc	300,000.00	300,000	
80	Premium for green roof	7,500	SF	35.00	262,500	
81	Premium for PV	10,500	SF	80.00	840,000	
82	ROOFING				2,055,500	\$50.75 / SF
83						
84	INTERIOR CONSTRUCTION					
85						
86	Interior Partitions					
87	New interior partitions and doors and specialties	40,500	SF	50.00	2,025,000	
88						
89						
90	INTERIOR CONSTRUCTION				2,025,000	\$50 / SF
91						
92	STAIRS					
93						
94	Interior stairs					
95						
96	New stairs main entry	1	FLT	60,000.00	60,000	
97	New stairs others	2	FLT	30,000.00	60,000	
98						
99						
100	STAIRS				120,000	\$2.96 / SF
101						
102	INTERIOR FINISHES					
103						
104	Floor finishes					
105	Floor protection	40,500	SF	1.00	40,500	591,250
106	Vapor retarder	40,500	SF	4.50	182,250	
107	New Flooring	35,500	SF	7.00	248,500	Carpet
108	Special flooring	5,000	SF	24.00	120,000	CT etc.
109						
110	Wall finishes					
111						
112	Painting to walls	40,500	SF	4.00	162,000	287,000
113	Finishes to columns	60	EA	1,000.00	60,000	
114	Special wall finishes	1	LS	65,000.00	65,000	
115						
116	Ceiling finishes					
117						485,500
118	New AT ceiling	37,500	SF	9.00	337,500	
119	Drywall ceiling	3,000	SF	16.00	48,000	
120	Bulkheads	1	LS	100,000.00	100,000	
121	Special ceilings	3,750	SF	35.00	131,250	

REF	DESCRIPTION	QUANTITY	UoM	UNIT RATE	TOTAL	COMMENTS
122						
123	Misc.					
124	Finishes not defined	1	LS	20,000.00	20,000	
125						
126						
127	INTERIOR FINISHES				1,515,000	\$37.41 / SF
128						
129	CONVEYING					
130						
131	New elevator and control three stops	1	LS	200,000.00	200,000	
132						
133						
134	CONVEYING				200,000	\$4.94 / SF
135						
136	PLUMBING					
137						
138	New plumbing system complete	40,500	SF	12.00	486,000	
139						
140						
141	PLUMBING				486,000	\$12 / SF
142						
143	HVAC					
144						
145	All New Mechanical system VAV air based plus reheat	40,500	SF	45.00	1,822,500	
146						
147	Premium f or geothermal system	40,500	SF	16.00	648,000	
148						
149						
150	HVAC				2,470,500	\$61 / SF
151						
152	FIRE PROTECTION					
153						
154	Sprinkler					
155						
156	New sprinkler system	40,500	GSF	5.50	222,750	
157						
158						
159	FIRE PROTECTION				222,750	\$5.5 / SF
160						
161	ELECTRICAL					
162						
163	Distribution ,connections, lighting etc.	40,500	SF	44.00	1,782,000	All new electrical system
164						
165	Telephone/Data	40,500	SF	8.00	324,000	
166						
167	CATV	40,500	SF	1.50	60,750	
168						
169	Security Systems	40,500	SF	2.00	81,000	
170						
171	Audio/Visual Systems	40,500	SF	3.00	121,500	
172						
173	Fire Alarm	40,500	SF	3.40	137,700	

Cupertino City Hall
Cupertino ,CA

NEW CONSTRUCTION

New Construction
Concept Development Phase

New Construction

OPTION 40,000SF

GSF :

40,500

REF	DESCRIPTION	QUANTITY	UoM	UNIT RATE	TOTAL	COMMENTS
174						
175	Misc. Electrical	40,500	SF	5.00	202,500	
176	Testing					
177	Seismic bracing					
178	Supervision					
179	Demolition - safe-off for demolition by others					
180	Non manual labor					
181	Misc. general requirements, trucks, safety etc.					
182	New emergency generator	1	LS	250,000.00	250,000	
183						
184						
185	ELECTRICAL				2,959,450	\$73.07 / SF
186						
187	EQUIPMENT					
188						
189	Equipment allowance	1	LS	75,000.00	75,000	Kitchen
190						
191						
192	EQUIPMENT				75,000	\$1.85 / SF
193						
194	FURNISHINGS					
195						
196	Casework	1	LS	250,000.00	250,000	
197						
198						
199	FURNISHINGS				250,000	\$6.17 / SF
200						
201	SPECIAL CONSTRUCTION					
202						
203	No work in this section					
204						
205						
206	SPECIAL CONSTRUCTION					\$0 / SF
207						
208	SELECTIVE BUILDING DEMOLITION					
209						
210	Demolition included within sitework costs					see sitework costs
211						
212						
213	SELECTIVE BUILDING DEMOLITION					\$0 / SF
214						
215	SITE PREPARATION					
216						
217	Site preparation included within sitework costs					see sitework costs
218						
219						
220	SITE PREPARATION					\$0 / SF
221						
222	SITE IMPROVEMENTS					
223						
224	Misc. site improvements	1	LS	100,000.00	100,000	SITWORK WITH BLDG
225						
226						
227	SITE IMPROVEMENTS				100,000	\$2.47 / SF
228						
229	SITE MECHANICAL UTILITIES					
230						
231	Allowance for revisions and hook ups	1	LS	150,000.00	150,000	
232						
233						
234	SITE MECHANICAL UTILITIES				150,000	\$3.7 / SF

Cupertino City Hall
Cupertino ,CA

NEW CONSTRUCTION

New Construction
Concept Development Phase

New Construction

OPTION 40,000SF

GSF :

40,500

REF	DESCRIPTION	QUANTITY	UoM	UNIT RATE	TOTAL	COMMENTS
235						
236	SITE ELECTRICAL UTILITIES					
237						
238	Allow for electrical utilities and site lighting	1	LS	120,000.00	120,000	
239						
240						
241	SITE ELECTRICAL UTILITIES				120,000	\$2.96 / SF
242						
243	OTHER SITE CONSTRUCTION					
244						
245	No work in this section					
246						
247						
248	OTHER SITE CONSTRUCTION					\$0 / SF

Cupertino City Hall
Cupertino ,CA

June 15, 2015

OPTION 35,000SF
New Construction



tbd consultants

111 Pine Street, Suite 1315
San Francisco, CA 94111
415.981.9430 phone (main)
415.981.9434 facsimile
www.tbdconsultants.com

Prepared for:

Perkins Will
2 Bryant Street
San Francisco, CA

TABLE OF CONTENTS

OPTION 35,000SF

CONTENTS

PAGE No.

Basis of Estimate

1

Key Criteria - Areas

4

Overall Summary

5

New Construction

Cost Summary

6

Detailed Estimate

7

PROJECT DESCRIPTION

The project involves the new construction of a two story building sitting on top of a one level parking structure podium
(parking structure costs taken with the parking costs)

REFERENCE DOCUMENTATION

Documents:

Civic Center Masterplan Document

Dated 12/11/14

MEETINGS

Meeting / ongoing discussions with Architect / design team

BASIS FOR PRICING

This estimate reflects the fair construction value for this project and should not be construed as a prediction of low bid. Prices are based on local prevailing wage construction costs at the time the estimate was prepared. Pricing assumes a procurement process with competitive bidding for all sub-trades of the construction work, which is to mean a minimum of 3 bids for all subcontractors and materials/equipment suppliers. If fewer bids are solicited or received, prices can be expected to be higher.

Subcontractor's markups have been included in each line item unit price. Markups cover the cost of field overhead, home office overhead and subcontractor's profit. Subcontractor's markups typically range from 15% to 25% of the unit price depending on market conditions.

General Contractor's/Construction Manager's Site Requirement costs are calculated on a percentage basis. General Contractor's/Construction Manager's Jobsite Management costs are also calculated on a percentage

General Contractor's/Construction Manager's overhead and fees are based on a percentage of the total direct costs plus general conditions, and covers the contractor's bond, insurance, site office overheads and profit.

BASIS OF ESTIMATE

OPTION 35,000SF

Unless identified otherwise, the cost of such items as overtime, shift premiums and construction phasing are not included in the line item unit price.

This cost estimate is based on standard industry practice, professional experience and knowledge of the local construction market costs. TBD Consultants have no control over the material and labor costs, contractors methods of establishing prices or the market and bidding conditions at the time of bid. Therefore TBD Consultants do not guarantee that the bids received will not vary from this cost estimate.

CONTINGENCY

Design Contingency **15%**

The Design Contingency is carried to cover scope that lacks definition and scope that is *anticipated* to be added to the Design. As the Design becomes more complete the Design Contingency will reduce.

Construction Contingency **10%**

The Construction Contingency is carried to cover the unforeseen during construction execution and Risks that do not currently have mitigation plans. As Risks are mitigated, Construction Contingency can be reduce, but should not be eliminated.

A Market Conditions Factor has not been included to reflect the current bidding climate where we should expect multiple bids for each trade. An owners contingency has not been included in this construction cost estimate, but it is advised that the owner carry additional contingency to cover scope change, claims and delays.

ESCALATION

Escalation has been included in the estimate -- see summary

EXCLUSIONS from CONSTRUCTION COST

- Land acquisition, feasibility, and financing costs
- All Owner soft costs
- All professional fees and insurance
- Construction Manager Agency Costs
- Site or existing condition survey investigation costs, including determination of subsoil conditions
- Hazardous materials inspection costs, or accommodations in construction for hazardous materials.
- Overtime, 2nd shift and lost productivity premiums - except where specifically identified
- Construction or occupancy phasing (current assumption is a single construction phase in a vacated building)
- Owners Construction Contingency for scope changes and market conditions at time of bid
- Permits

ITEMS THAT MAY AFFECT THIS ESTIMATE

Such items include, but are not limited to the following:

- Modifications to the scope of work subsequent to the preparation of this estimate
- Unforeseen existing conditions
- Compression of planned construction schedule (current assumption is approx. 6 months+ duration)
- Special requirements for site access, off-hour work or phasing activities
- Restrictive technical specifications, excessive contract or non-competitive bid conditions
- Sole source specifications for materials, products or equipment
- Bid approvals delayed beyond the anticipated project schedule

KEY CRITERIA

OPTION 35,000SF

AREA TABULATION

New Construction

Location	Enclosed	Perimeter	Height	Area	Comment
First Floor	SF 17,500	610	20.00	SF 12,200	
Second floor	17,500	610	15.00	9,150	
Third floor		0			
Subtotal	35,000 SF	1,220 SF	35.00 LF	21,350.00	
Covered Area @ 50%	500 SF				Allow
TOTAL	35,500 SF				

OVERALL SUMMARY

OPTION 35,000SF

	GROSS FLOOR AREA	COST (\$/SF)	COST (\$'s)
New Construction	35,500	\$754	\$26,773,826
Moving cost			\$200,000
Rental of interim space for 18 months			
22,500 SF at \$5/SF per month	24 months		\$2,700,000
EOC Buildig ON site			NA
Hazmat abatement	Allowance		\$225,000
Soft costs	25% of direct cost		\$6,693,457
FFE	All new	35/SF	\$1,242,500
Construction Contingency	10% or direct cost		\$2,677,383
TOTAL including soft and hard cost			\$40,512,166

UNIFORMAT II SUMMARY

Gross Square Feet: 35,500

New Construction

OPTION 35,000SF

SECTION	%	\$	\$ / SF	COMMENTS
10 FOUNDATIONS	2.7%	455,000	12.82	
20 BASEMENT CONSTRUCTION	1.0%	175,000	4.93	
A SUBSTRUCTURE	3.7%	630,000	17.75	
10 SUPERSTRUCTURE	11.5%	1,958,000	55.15	
20 EXTERIOR CLOSURE	17.0%	2,879,450	81.11	
30 ROOFING	11.4%	1,935,000	54.51	
B SHELL	39.9%	6,772,450	190.77	
10 INTERIOR CONSTRUCTION	10.5%	1,775,000	50.00	
20 STAIRS	0.7%	120,000	3.38	
30 INTERIOR FINISHES	8.0%	1,362,000	38.37	
C INTERIORS	19.2%	3,257,000	91.75	
10 CONVEYING	1.2%	200,000	5.63	
20 PLUMBING	2.5%	426,000	12.00	
30 HVAC	12.8%	2,165,500	61.00	
40 FIRE PROTECTION	1.2%	195,250		
50 ELECTRICAL	15.5%	2,624,950	73.94	
D SERVICES	33.1%	5,611,700	158.08	
10 EQUIPMENT	0.4%	75,000	2.11	
20 FURNISHINGS	1.5%	250,000	7.04	
E EQUIPMENT + FURNISHINGS	1.9%	325,000	9.15	
10 SPECIAL CONSTRUCTION				
20 SELECTIVE BUILDING DEMOLITION				
F SPECIAL CONSTRUCTION + DEMOLITION				
10 SITE PREPARATION				
20 SITE IMPROVEMENTS	0.6%	100,000	2.82	
30 SITE MECHANICAL UTILITIES	0.9%	150,000	4.23	
40 SITE ELECTRICAL UTILITIES	0.7%	120,000	3.38	
50 OTHER SITE CONSTRUCTION				
G BUILDING SITEWORK	2.2%	370,000	10.42	
DIRECT COSTS	100%	16,966,150	477.92	
SITE REQUIREMENTS	3.0%	508,985	14.34	
JOBSITE MANAGEMENT	8.0%	1,357,292	38.23	
ESTIMATE SUB-TOTAL		18,832,427	530.49	
INSURANCE + BONDING	2.5%	470,811	13.26	
FEE	5.0%	941,621	26.52	
ESTIMATE SUB-TOTAL		20,244,859	570.28	
DESIGN CONTINGENCY	15.0%	3,036,729	85.54	
CONSTRUCTION CONTINGENCY	N/A			Owner to carry
ESTIMATE SUB-TOTAL		23,281,588	655.82	
ESCALATION 3 years to mid point	15.0%	3,492,238	98.37	
ESTIMATE TOTAL		\$ 26,773,826	754.19	total add-ons 57.81%

REF	DESCRIPTION	QUANTITY	UoM	UNIT RATE	TOTAL	COMMENTS
1						
2	FOUNDATIONS					
3						
4	Foundation allocation	17,500	SF	16.00	280,000	
5	(allocation of foundation costs and misc. items)					
6						
7	Special foundations		NA			
8						
9	Slab on grade -- topping slab	17,500	SF	10.00	175,000	Including curbs etc.
10						
11						
12	FOUNDATIONS				455,000	\$12.82 / SF
13						
14	BASEMENT CONSTRUCTION					
15						
16	Shear walls for elevators etc.	17,500	SF	10.00	175,000	Storage?
17						
18						
19	BASEMENT CONSTRUCTION				175,000	\$4.93 / SF
20						
21	SUPERSTRUCTURE					
22						
23	<u>Floor & Roof Construction</u>					
24						
25	<u>Steel construction</u>					
26						
27	Steel frame					
28	Structural steel moment frame	357	T	4,000.00	1,428,000	
29	Fireproofing		NA			
30	Metal deck					
31	Floor	17,500	SF	4.15	72,625	
32	Roof	17,500	SF	3.85	67,375	
33	Concrete fill to metal deck, reinforced	35,000	SF	6.15	215,250	
34	Slab edge closure		NA			incl above
35	Form openings in deck	1	LS	10,000.00	10,000	
36						
37	Spray fireproofing to u/side of decks		NA			
38	Curbs at plumbing walls etc	1	LS	4,000.00	4,000	
39						
40	Miscellaneous					
41						
42	Allow for miscellaneous structural supports	1	LS	25,000.00	25,000	Pads etc
43	Structural supports to parapet	1	LS	20,000.00	20,000	
44	Allow for miscellaneous metals	35,500	SF	2.50	88,750	
45	Fire stopping	1,500	LF	18.00	27,000	
46						
47						
48	SUPERSTRUCTURE				1,958,000	\$55.15 / SF
49						
50	EXTERIOR CLOSURE					
51						
52	Exterior Walls					
53						
54	Above grade ext skin	23,180	SF	90.00	2,086,200	
55	Windows curtain walling premium	4,000	SF	95.00	380,000	Premium
56						
57	Soffits	1	LS	100,000.00	100,000	
58	Fins and louvers	1	LS	200,000.00	200,000	
59						
60	Misc					
61	Caulking joints etc.	35,500	SF	1.50	53,250	

REF	DESCRIPTION	QUANTITY	UoM	UNIT RATE	TOTAL	COMMENTS
62						
63	Exterior Doors					
64						
65	New doors	1	LS	60,000.00	60,000	
66						
67						
68	EXTERIOR CLOSURE				2,879,450	\$81.11 / SF
69						
70	ROOFING					
71						
72	Metal sloped roofing	11,000	SF	30.00	330,000	
73						
74	Flat roofing	7,500	SF	22.00	165,000	
75						
76	New mechanical pads on roof	1	LS	20,000.00	20,000	
77						
78	Roof screens	1	LS	75,000.00	75,000	
79	Skylights	1	Loc	300,000.00	300,000	
80	Premium for green roof	7,000	SF	35.00	245,000	
81	Premium for PV	10,000	SF	80.00	800,000	
82	ROOFING				1,935,000	\$54.51 / SF
83						
84	INTERIOR CONSTRUCTION					
85						
86	Interior Partitions					
87	New interior partitions and doors and specialties	35,500	SF	50.00	1,775,000	
88						
89						
90	INTERIOR CONSTRUCTION				1,775,000	\$50 / SF
91						
92	STAIRS					
93						
94	Interior stairs					
95						
96	New stairs main entry	1	FLT	60,000.00	60,000	
97	New stairs others	2	FLT	30,000.00	60,000	
98						
99						
100	STAIRS				120,000	\$3.38 / SF
101						
102	INTERIOR FINISHES					
103						
104	Floor finishes					
105	Floor protection	35,500	SF	1.00	35,500	528,750
106	Vapor retarder	35,500	SF	4.50	159,750	
107	New Flooring	30,500	SF	7.00	213,500	Carpet
108	Special flooring	5,000	SF	24.00	120,000	CT etc.
109						
110	Wall finishes					
111						
112	Painting to walls	35,500	SF	4.00	142,000	259,000
113	Finishes to columns	52	EA	1,000.00	52,000	
114	Special wall finishes	1	LS	65,000.00	65,000	
115						
116	Ceiling finishes					
117						440,500
118	New AT ceiling	32,500	SF	9.00	292,500	
119	Drywall ceiling	3,000	SF	16.00	48,000	
120	Bulkheads	1	LS	100,000.00	100,000	
121	Special ceilings	3,250	SF	35.00	113,750	

Cupertino City Hall
Cupertino ,CA

NEW CONSTRUCTION

New Construction
Concept Development Phase

New Construction

OPTION 35,000SF

GSF :

35,500

REF	DESCRIPTION	QUANTITY	UoM	UNIT RATE	TOTAL	COMMENTS
122						
123	Misc.					
124	Finishes not defined	1	LS	20,000.00	20,000	
125						
126						
127	INTERIOR FINISHES				1,362,000	\$38.37 / SF
128						
129	CONVEYING					
130						
131	New elevator and control three stops	1	LS	200,000.00	200,000	
132						
133						
134	CONVEYING				200,000	\$5.63 / SF
135						
136	PLUMBING					
137						
138	New plumbing system complete	35,500	SF	12.00	426,000	
139						
140						
141	PLUMBING				426,000	\$12 / SF
142						
143	HVAC					
144						
145	All New Mechanical system VAV air based plus reheat	35,500	SF	45.00	1,597,500	
146						
147	Premium f or geothermal system	35,500	SF	16.00	568,000	
148						
149						
150	HVAC				2,165,500	\$61 / SF
151						
152	FIRE PROTECTION					
153						
154	Sprinkler					
155						
156	New sprinkler system	35,500	GSF	5.50	195,250	
157						
158						
159	FIRE PROTECTION				195,250	\$5.5 / SF
160						
161	ELECTRICAL					
162						
163	Distribution ,connections, lighting etc.	35,500	SF	44.00	1,562,000	All new electrical system
164						
165	Telephone/Data	35,500	SF	8.00	284,000	
166						
167	CATV	35,500	SF	1.50	53,250	
168						
169	Security Systems	35,500	SF	2.00	71,000	
170						
171	Audio/Visual Systems	35,500	SF	3.00	106,500	
172						
173	Fire Alarm	35,500	SF	3.40	120,700	

Cupertino City Hall
Cupertino ,CA

NEW CONSTRUCTION

New Construction
Concept Development Phase

New Construction

OPTION 35,000SF

GSF :

35,500

REF	DESCRIPTION	QUANTITY	UoM	UNIT RATE	TOTAL	COMMENTS
174						
175	Misc. Electrical	35,500	SF	5.00	177,500	
176	Testing					
177	Seismic bracing					
178	Supervision					
179	Demolition - safe-off for demolition by others					
180	Non manual labor					
181	Misc. general requirements, trucks, safety etc.					
182	New emergency generator	1	LS	250,000.00	250,000	
183						
184						
185	ELECTRICAL				2,624,950	\$73.94 / SF
186						
187	EQUIPMENT					
188						
189	Equipment allowance	1	LS	75,000.00	75,000	Kitchen
190						
191						
192	EQUIPMENT				75,000	\$2.11 / SF
193						
194	FURNISHINGS					
195						
196	Casework	1	LS	250,000.00	250,000	
197						
198						
199	FURNISHINGS				250,000	\$7.04 / SF
200						
201	SPECIAL CONSTRUCTION					
202						
203	No work in this section					
204						
205						
206	SPECIAL CONSTRUCTION					\$0 / SF
207						
208	SELECTIVE BUILDING DEMOLITION					
209						
210	Demolition included within sitework costs					see sitework costs
211						
212						
213	SELECTIVE BUILDING DEMOLITION					\$0 / SF
214						
215	SITE PREPARATION					
216						
217	Site preparation included within sitework costs					see sitework costs
218						
219						
220	SITE PREPARATION					\$0 / SF
221						
222	SITE IMPROVEMENTS					
223						
224	Misc. site improvements	1	LS	100,000.00	100,000	SITWORK WITH BLDG
225						
226						
227	SITE IMPROVEMENTS				100,000	\$2.82 / SF
228						
229	SITE MECHANICAL UTILITIES					
230						
231	Allowance for revisions and hook ups	1	LS	150,000.00	150,000	
232						
233						
234	SITE MECHANICAL UTILITIES				150,000	\$4.23 / SF

Cupertino City Hall
Cupertino ,CA

NEW CONSTRUCTION

New Construction
Concept Development Phase

New Construction

OPTION 35,000SF

GSF :

35,500

REF	DESCRIPTION	QUANTITY	UoM	UNIT RATE	TOTAL	COMMENTS
235						
236	SITE ELECTRICAL UTILITIES					
237						
238	Allow for electrical utilities and site lighting	1	LS	120,000.00	120,000	
239						
240						
241	SITE ELECTRICAL UTILITIES				120,000	\$3.38 / SF
242						
243	OTHER SITE CONSTRUCTION					
244						
245	No work in this section					
246						
247						
248	OTHER SITE CONSTRUCTION					\$0 / SF

Cupertino City Hall
Cupertino ,CA

June 15, 2015

OPTION 30,000SF
New Construction



tbd consultants

111 Pine Street, Suite 1315
San Francisco, CA 94111
415.981.9430 phone (main)
415.981.9434 facsimile
www.tbdconsultants.com

Prepared for:

Perkins Will
2 Bryant Street
San Francisco, CA

TABLE OF CONTENTS

OPTION 30,000SF

CONTENTS

PAGE No.

Basis of Estimate

1

Key Criteria - Areas

4

Overall Summary

5

New Construction

Cost Summary

6

Detailed Estimate

7

PROJECT DESCRIPTION

The project involves the new construction of a two story building sitting on top of a one level parking structure podium
(parking structure costs taken with the parking costs)

REFERENCE DOCUMENTATIONDocuments:

Civic Center Masterplan Document

Dated 12/11/14

MEETINGS

Meeting / ongoing discussions with Architect / design team

BASIS FOR PRICING

This estimate reflects the fair construction value for this project and should not be construed as a prediction of low bid. Prices are based on local prevailing wage construction costs at the time the estimate was prepared. Pricing assumes a procurement process with competitive bidding for all sub-trades of the construction work, which is to mean a minimum of 3 bids for all subcontractors and materials/equipment suppliers. If fewer bids are solicited or received, prices can be expected to be higher.

Subcontractor's markups have been included in each line item unit price. Markups cover the cost of field overhead, home office overhead and subcontractor's profit. Subcontractor's markups typically range from 15% to 25% of the unit price depending on market conditions.

General Contractor's/Construction Manager's Site Requirement costs are calculated on a percentage basis. General Contractor's/Construction Manager's Jobsite Management costs are also calculated on a percentage

General Contractor's/Construction Manager's overhead and fees are based on a percentage of the total direct costs plus general conditions, and covers the contractor's bond, insurance, site office overheads and profit.

BASIS OF ESTIMATE

OPTION 30,000SF

Unless identified otherwise, the cost of such items as overtime, shift premiums and construction phasing are not included in the line item unit price.

This cost estimate is based on standard industry practice, professional experience and knowledge of the local construction market costs. TBD Consultants have no control over the material and labor costs, contractors methods of establishing prices or the market and bidding conditions at the time of bid. Therefore TBD Consultants do not guarantee that the bids received will not vary from this cost estimate.

CONTINGENCY

Design Contingency **15%**

The Design Contingency is carried to cover scope that lacks definition and scope that is *anticipated* to be added to the Design. As the Design becomes more complete the Design Contingency will reduce.

Construction Contingency **10%**

The Construction Contingency is carried to cover the unforeseen during construction execution and Risks that do not currently have mitigation plans. As Risks are mitigated, Construction Contingency can be reduce, but should not be eliminated.

A Market Conditions Factor has not been included to reflect the current bidding climate where we should expect multiple bids for each trade. An owners contingency has not been included in this construction cost estimate, but it is advised that the owner carry additional contingency to cover scope change, claims and delays.

ESCALATION

Escalation has been included in the estimate -- see summary

EXCLUSIONS from CONSTRUCTION COST

- Land acquisition, feasibility, and financing costs
- All Owner soft costs
- All professional fees and insurance
- Construction Manager Agency Costs
- Site or existing condition survey investigation costs, including determination of subsoil conditions
- Hazardous materials inspection costs, or accommodations in construction for hazardous materials.
- Overtime, 2nd shift and lost productivity premiums - except where specifically identified
- Construction or occupancy phasing (current assumption is a single construction phase in a vacated building)
- Owners Construction Contingency for scope changes and market conditions at time of bid
- Permits

ITEMS THAT MAY AFFECT THIS ESTIMATE

Such items include, but are not limited to the following:

- Modifications to the scope of work subsequent to the preparation of this estimate
- Unforeseen existing conditions
- Compression of planned construction schedule (current assumption is approx. 6 months+ duration)
- Special requirements for site access, off-hour work or phasing activities
- Restrictive technical specifications, excessive contract or non-competitive bid conditions
- Sole source specifications for materials, products or equipment
- Bid approvals delayed beyond the anticipated project schedule

KEY CRITERIA

OPTION 30,000SF

AREA TABULATION

New Construction

Location	Enclosed	Perimeter	Height	Area	Comment
First Floor	SF 15,000	580	20.00	SF 11,600	
Second floor	15,000	580	15.00	8,700	
Third floor		0			
Subtotal	30,000 SF	1,160 SF	35.00 LF	20,300.00	
Covered Area @ 50%	500 SF				Allow
TOTAL	30,500 SF				

OVERALL SUMMARY

OPTION 30,000SF

	GROSS FLOOR AREA	COST (\$/SF)	COST (\$'s)
New Construction	30,500	\$779	\$23,750,001
Moving cost			\$200,000
Rental of interim space for 18 months			
22,500 SF at \$5/SF per month	24 months		\$2,700,000
EOC Buildig ON site			NA
Hazmat abatement	Allowance		\$225,000
Soft costs	25% of direct cost		\$5,937,500
FFE	All new	35/SF	\$1,067,500
Construction Contingency	10% or direct cost		\$2,375,000
TOTAL including soft and hard cost			\$36,255,001

UNIFORMAT II SUMMARY

Gross Square Feet: 30,500

New Construction

OPTION 30,000SF

SECTION	%	\$	\$ / SF	COMMENTS
10 FOUNDATIONS	2.6%	390,000	12.79	
20 BASEMENT CONSTRUCTION	1.0%	150,000	4.92	
A SUBSTRUCTURE	3.6%	540,000	17.70	
10 SUPERSTRUCTURE	10.3%	1,556,950	51.05	
20 EXTERIOR CLOSURE	18.4%	2,769,350	90.80	
30 ROOFING	11.6%	1,749,000	57.34	
B SHELL	40.4%	6,075,300	199.19	
10 INTERIOR CONSTRUCTION	10.1%	1,525,000	50.00	
20 STAIRS	0.8%	120,000	3.93	
30 INTERIOR FINISHES	8.0%	1,210,000	39.67	
C INTERIORS	19.0%	2,855,000	93.61	
10 CONVEYING	1.3%	200,000	6.56	
20 PLUMBING	2.4%	366,000	12.00	
30 HVAC	12.4%	1,860,500	61.00	
40 FIRE PROTECTION	1.1%	167,750		
50 ELECTRICAL	15.2%	2,290,450	75.10	
D SERVICES	32.5%	4,884,700	160.15	
10 EQUIPMENT	0.5%	75,000	2.46	
20 FURNISHINGS	1.7%	250,000	8.20	
E EQUIPMENT + FURNISHINGS	2.2%	325,000	10.66	
10 SPECIAL CONSTRUCTION				
20 SELECTIVE BUILDING DEMOLITION				
F SPECIAL CONSTRUCTION + DEMOLITION				
10 SITE PREPARATION				
20 SITE IMPROVEMENTS	0.7%	100,000	3.28	
30 SITE MECHANICAL UTILITIES	1.0%	150,000	4.92	
40 SITE ELECTRICAL UTILITIES	0.8%	120,000	3.93	
50 OTHER SITE CONSTRUCTION				
G BUILDING SITEWORK	2.5%	370,000	12.13	
DIRECT COSTS	100%	15,050,000	493.44	
SITE REQUIREMENTS	3.0%	451,500	14.80	
JOBSITE MANAGEMENT	8.0%	1,204,000	39.48	
ESTIMATE SUB-TOTAL		16,705,500	547.72	
INSURANCE + BONDING	2.5%	417,638	13.69	
FEE	5.0%	835,275	27.39	
ESTIMATE SUB-TOTAL		17,958,413	588.80	
DESIGN CONTINGENCY	15.0%	2,693,762	88.32	
CONSTRUCTION CONTINGENCY	N/A			Owner to carry
ESTIMATE SUB-TOTAL		20,652,175	677.12	
ESCALATION 3 years to mid point	15.0%	3,097,826	101.57	
ESTIMATE TOTAL		\$ 23,750,001	778.69	total add-ons 57.81%

REF	DESCRIPTION	QUANTITY	UoM	UNIT RATE	TOTAL	COMMENTS
1						
2	FOUNDATIONS					
3						
4	Foundation allocation	15,000	SF	16.00	240,000	
5	<i>(allocation of foundation costs and misc. items)</i>					
6						
7	Special foundations		NA			
8						
9	Slab on grade -- topping slab	15,000	SF	10.00	150,000	Including curbs etc.
10						
11						
12	FOUNDATIONS				390,000	\$12.79 / SF
13						
14	BASEMENT CONSTRUCTION					
15						
16	Shear walls for elevators etc.	15,000	SF	10.00	150,000	Storage?
17						
18						
19	BASEMENT CONSTRUCTION				150,000	\$4.92 / SF
20						
21	SUPERSTRUCTURE					
22						
23	<u>Floor & Roof Construction</u>					
24						
25	<i>Steel construction</i>					
26						
27	Steel frame					
28	Structural steel moment frame	273	T	4,000.00	1,092,000	
29	Fireproofing		NA			
30	Metal deck					
31	Floor	15,000	SF	4.15	62,250	
32	Roof	15,000	SF	3.85	57,750	
33	Concrete fill to metal deck, reinforced	30,000	SF	6.15	184,500	
34	Slab edge closure		NA			incl above
35	Form openings in deck	1	LS	10,000.00	10,000	
36						
37	Spray fireproofing to u/side of decks		NA			
38	Curbs at plumbing walls etc	1	LS	4,000.00	4,000	
39						
40	Miscellaneous					
41						
42	Allow for miscellaneous structural supports	1	LS	25,000.00	25,000	Pads etc
43	Structural supports to parapet	1	LS	20,000.00	20,000	
44	Allow for miscellaneous metals	30,500	SF	2.50	76,250	
45	Fire stopping	1,400	LF	18.00	25,200	
46						
47						
48	SUPERSTRUCTURE				1,556,950	\$51.05 / SF
49						
50	EXTERIOR CLOSURE					
51						
52	Exterior Walls					
53						
54	Above grade ext skin	22,040	SF	90.00	1,983,600	
55	Windows curtain walling premium	4,000	SF	95.00	380,000	Premium
56						
57	Soffits	1	LS	100,000.00	100,000	
58	Fins and louvers	1	LS	200,000.00	200,000	
59						
60	Misc					
61	Caulking joints etc.	30,500	SF	1.50	45,750	

REF	DESCRIPTION	QUANTITY	UoM	UNIT RATE	TOTAL	COMMENTS
62						
63	Exterior Doors					
64						
65	New doors	1	LS	60,000.00	60,000	
66						
67						
68	EXTERIOR CLOSURE				2,769,350	\$90.8 / SF
69						
70	ROOFING					
71						
72	Metal sloped roofing	9,000	SF	30.00	270,000	
73						
74	Flat roofing	7,000	SF	22.00	154,000	
75						
76	New mechanical pads on roof	1	LS	20,000.00	20,000	
77						
78	Roof screens	1	LS	75,000.00	75,000	
79	Skylights	1	Loc	300,000.00	300,000	
80	Premium for green roof	6,000	SF	35.00	210,000	
81	Premium for PV	9,000	SF	80.00	720,000	
82	ROOFING				1,749,000	\$57.34 / SF
83						
84	INTERIOR CONSTRUCTION					
85						
86	Interior Partitions					
87	New interior partitions and doors and specialties	30,500	SF	50.00	1,525,000	
88						
89						
90	INTERIOR CONSTRUCTION				1,525,000	\$50 / SF
91						
92	STAIRS					
93						
94	Interior stairs					
95						
96	New stairs main entry	1	FLT	60,000.00	60,000	
97	New stairs others	2	FLT	30,000.00	60,000	
98						
99						
100	STAIRS				120,000	\$3.93 / SF
101						
102	INTERIOR FINISHES					
103						
104	Floor finishes					
105	Floor protection	30,500	SF	1.00	30,500	466,250
106	Vapor retarder	30,500	SF	4.50	137,250	
107	New Flooring	25,500	SF	7.00	178,500	Carpet
108	Special flooring	5,000	SF	24.00	120,000	CT etc.
109						
110	Wall finishes					
111						
112	Painting to walls	30,500	SF	4.00	122,000	232,000
113	Finishes to columns	50	EA	1,000.00	50,000	
114	Special wall finishes	1	LS	60,000.00	60,000	
115						
116	Ceiling finishes					
117						395,500
118	New AT ceiling	27,500	SF	9.00	247,500	
119	Drywall ceiling	3,000	SF	16.00	48,000	
120	Bulkheads	1	LS	100,000.00	100,000	
121	Special ceilings	2,750	SF	35.00	96,250	

Cupertino City Hall
Cupertino ,CA

NEW CONSTRUCTION

New Construction
Concept Development Phase

New Construction

OPTION 30,000SF

GSF :

30,500

REF	DESCRIPTION	QUANTITY	UoM	UNIT RATE	TOTAL	COMMENTS
122						
123	Misc.					
124	Finishes not defined	1	LS	20,000.00	20,000	
125						
126						
127	INTERIOR FINISHES				1,210,000	\$39.67 / SF
128						
129	CONVEYING					
130						
131	New elevator and control three stops	1	LS	200,000.00	200,000	
132						
133						
134	CONVEYING				200,000	\$6.56 / SF
135						
136	PLUMBING					
137						
138	New plumbing system complete	30,500	SF	12.00	366,000	
139						
140						
141	PLUMBING				366,000	\$12 / SF
142						
143	HVAC					
144						
145	All New Mechanical system VAV air based plus reheat	30,500	SF	45.00	1,372,500	
146						
147	Premium for geothermal system	30,500	SF	16.00	488,000	
148						
149						
150	HVAC				1,860,500	\$61 / SF
151						
152	FIRE PROTECTION					
153						
154	Sprinkler					
155						
156	New sprinkler system	30,500	GSF	5.50	167,750	
157						
158						
159	FIRE PROTECTION				167,750	\$5.5 / SF
160						
161	ELECTRICAL					
162						
163	Distribution ,connections, lighting etc.	30,500	SF	44.00	1,342,000	All new electrical system
164						
165	Telephone/Data	30,500	SF	8.00	244,000	
166						
167	CATV	30,500	SF	1.50	45,750	
168						
169	Security Systems	30,500	SF	2.00	61,000	
170						
171	Audio/Visual Systems	30,500	SF	3.00	91,500	
172						
173	Fire Alarm	30,500	SF	3.40	103,700	
174						

Cupertino City Hall
Cupertino ,CA

NEW CONSTRUCTION

New Construction
Concept Development Phase

New Construction

OPTION 30,000SF

GSF :

30,500

REF	DESCRIPTION	QUANTITY	UoM	UNIT RATE	TOTAL	COMMENTS
175	Misc. Electrical	30,500	SF	5.00	152,500	
176	Testing					
177	Seismic bracing					
178	Supervision					
179	Demolition - safe-off for demolition by others					
180	Non manual labor					
181	Misc. general requirements, trucks, safety etc.					
182	New emergency generator	1	LS	250,000.00	250,000	
183						
184						
185	ELECTRICAL				2,290,450	\$75.1 / SF
186						
187	EQUIPMENT					
188						
189	Equipment allowance	1	LS	75,000.00	75,000	Kitchen
190						
191						
192	EQUIPMENT				75,000	\$2.46 / SF
193						
194	FURNISHINGS					
195						
196	Casework	1	LS	250,000.00	250,000	
197						
198						
199	FURNISHINGS				250,000	\$8.2 / SF
200						
201	SPECIAL CONSTRUCTION					
202						
203	No work in this section					
204						
205						
206	SPECIAL CONSTRUCTION					\$0 / SF
207						
208	SELECTIVE BUILDING DEMOLITION					
209						
210	Demolition included within sitework costs					see sitework costs
211						
212						
213	SELECTIVE BUILDING DEMOLITION					\$0 / SF
214						
215	SITE PREPARATION					
216						
217	Site preparation included within sitework costs					see sitework costs
218						
219						
220	SITE PREPARATION					\$0 / SF
221						
222	SITE IMPROVEMENTS					
223						
224	Misc. site improvements	1	LS	100,000.00	100,000	SITWORK WITH BLDG
225						
226						
227	SITE IMPROVEMENTS				100,000	\$3.28 / SF
228						
229	SITE MECHANICAL UTILITIES					
230						
231	Allowance for revisions and hook ups	1	LS	150,000.00	150,000	
232						
233						
234	SITE MECHANICAL UTILITIES				150,000	\$4.92 / SF

Cupertino City Hall
Cupertino ,CA

NEW CONSTRUCTION

New Construction
Concept Development Phase

New Construction

OPTION 30,000SF

GSF :

30,500

REF	DESCRIPTION	QUANTITY	UoM	UNIT RATE	TOTAL	COMMENTS
235						
236	SITE ELECTRICAL UTILITIES					
237						
238	Allow for electrical utilities and site lighting	1	LS	120,000.00	120,000	
239						
240						
241	SITE ELECTRICAL UTILITIES				120,000	\$3.93 / SF
242						
243	OTHER SITE CONSTRUCTION					
244						
245	No work in this section					
246						
247						
248	OTHER SITE CONSTRUCTION					\$0 / SF

APPENDIX A - 17

City Hall Parking Cost Estimate (TBD June 15, 2015)

Cupertino Civic Center Masterplan

Parking Below City Hall

Cupertino CA

118 Space Option

Concept Cost Estimate

June 15, 2015

Prepared By:



111 Pine Street, Suite 1315
San Francisco, CA 94111
415.981.9430 phone (main)
415.981.9434 facsimile
www.tbdconsultants.com

Prepared for:

Perkins Will
2 Bryant Street
San Francisco, CA

TABLE OF CONTENTS

SECTION	PAGE NUMBER
BASIS OF ESTIMATE	1
KEY CRITERIA	5
OVERALL SUMMARY	
UNIFORMAT II SUMMARY	7
ESTIMATE DETAIL	10

BASIS OF ESTIMATE

PROJECT DESCRIPTION

This project involves a one story underground carpark with podium above

REFERENCE DOCUMENTATION

This Construction Cost Estimate was produced from the following documentation by International Parking Design and engineering changes occurring subsequent to the issue of these documents have not been incorporated in this estimate.

Document

-
-

BASIS FOR PRICING

This estimate reflects the fair construction value for this project and should not be construed as a prediction of low bid. Prices are based on local prevailing wage construction costs at the time the estimate was prepared. Pricing assumes a procurement process with competitive bidding for all sub-trades of the construction work, which is to mean a minimum of 3 bids for all subcontractors and materials/equipment suppliers. If fewer bids are solicited or received, prices can be expected to be higher.

Subcontractor's markups have been included in each line item unit price. Markups cover the cost of field overhead, home office overhead and subcontractor's profit. Subcontractor's markups typically range from 15% to 25% of the unit price depending on market conditions.

General Contractor's/Construction Manager's Site Requirement costs are calculated on a percentage basis. General Contractor's/Construction Manager's Jobsite Management costs are also calculated on a percentage basis.

General Contractor's/Construction Manager's overhead and fees are based on a percentage of the total direct costs plus general conditions, and covers the contractor's bond, insurance, site office overheads and profit.

Unless identified otherwise, the cost of such items as overtime, shift premiums and construction phasing are not included in the line item unit price.

This cost estimate is based on standard industry practice, professional experience and knowledge of the local construction market costs. TBD Consultants have no control over the material and labor costs, contractors' methods of establishing prices or the market and bidding conditions at the time of bid. Therefore TBD Consultants do not guarantee that the bids received will not vary from this cost estimate.

CONTINGENCY

Design Contingency 10%

The Design Contingency is carried to cover scope that lacks definition and scope that is *anticipated* to be added to the Design. As the Design becomes more complete the Design Contingency will reduce.

Construction Contingency 0% *Carried else where in owners budget*

The Construction Contingency is carried to cover the unforeseen during construction execution and Risks that do not currently have mitigation plans. As Risks are mitigated, Construction Contingency can be reduced, but should not be eliminated.

ESCALATION

BASIS OF ESTIMATE

Escalation has been added to the estimate to reflect the anticipated increases in labor and materials up until the mid point of construction. Escalation is calculated as being compound.

Escalation Per Year

<u>Year</u>	<u>Escalation</u>
2014	5.00%
2015	5.00%
2016	5.00%

This calculation does not account for adverse bidding conditions and a separate Bid Contingency should be carried if there are limited qualified bidders or if a market research study indicates.

EXCLUSIONS

- Land acquisition, feasibility, and financing costs
- All Owner soft costs
- All professional fees and insurance
- Construction Manager Costs
- Site or existing condition survey investigation costs, including determination of subsoil conditions
- Hazardous materials inspection costs
- AV networks, equipment or software (unless identified otherwise)
- Primary and secondary electrical cabling, master clock system
- Third party MEP commissioning
- Rock excavation
- Utility company back charges, including work required off-site
- Overtime, 2nd shift and lost productivity premiums
- Construction or occupancy phasing
- Owners Construction Contingency for scope changes and market conditions at time of bid
- Owner supplied and installed furniture, fixtures and equipment
- Items identified in the design as Not In Contract (NIC)
- Work to City streets and sidewalks, [except as noted in this estimate]
- Permits

BASIS OF ESTIMATE

ITEMS THAT MAY AFFECT THIS ESTIMATE

Such items include, but are not limited to the following:

- Modifications to the scope of work subsequent to the preparation of this estimate
- Unforeseen subsurface conditions
- Special requirements for site access, off-hour work or phasing activities
- Restrictive technical specifications, excessive contract or non-competitive bid conditions
- Sole source specifications for materials or products
- Bid approvals delayed beyond the anticipated project schedule

GENERAL ACKNOWLEDGEMENTS

Requests for modifications of any apparent errors or omissions in this document must be made to tbd Consultants within ten (10) working days of receipt of this estimate. Otherwise it will be understood that the contents have been concurred with and accepted.

Since tbd Consultants has no control over the cost of labor, materials, equipment, the contractors method of estimating prices, competitive bidding or market conditions, the opinion of probable construction cost provided for herein is made on our best professional judgment.

KEY CRITERIA

Parking Below City Hall

AREA TABULATION

	Enclosed	Perimeter	Height	Comment
Basement	47,000	900	11.3	
				Roof Level
Subtotal	47,000	900 LF	11.3 LF	

BUILDING CRITERIA

Parking Stalls **118 EA**
 Space per stall **398 SF**

CONSTRUCTION SCHEDULE

Construction Start Date	0-Jan-00	Construction End Date
Mid-date of Construction	0-Jan-00	Construction Duration
Escalation Period		

OVERALL SUMMARY

Parking Below City Hall

	GROSS FLOOR AREA	COST (\$/SF)	COST (\$'s)
Parking Below City Hall	47,000	\$186	\$8,741,433
Moving cost			
Rental of interim space for 18 months			
EOC Buildig ON site			NA
Hazmat abatement	Allowance		
Soft costs	20% of direct cost		\$2,185,358
FFE			
Construction Contingency	10% or direct cost		\$874,143
TOTAL including soft and hard cost			\$11,800,934

Parking Below City Hall

UNIFORMAT II SUMMARY

GSF : 47,000

SECTION	%	SUB TOTAL	TOTAL	\$/ SF	COMMENTS
A SUBSTRUCTURE	42.5%		2,567,931	54.64	
10 FOUNDATIONS	14.8%	894,250		19.03	
20 BASEMENT CONSTRUCTION	27.7%	1,673,681		35.61	
B SHELL	41.3%		2,495,319	53.09	
10 SUPERSTRUCTURE	34.6%	2,088,819		44.44	
20 EXTERIOR CLOSURE	6.6%	400,000		8.51	
30 ROOFING	0.1%	6,500		0.14	
C INTERIORS	3.6%		216,900	4.61	
10 INTERIOR CONSTRUCTION	2.2%	134,500		2.86	
20 STAIRS	0.4%	26,000		0.55	
30 INTERIOR FINISHES	0.9%	56,400		1.20	
D SERVICES	11.6%		697,235	14.83	
10 CONVEYING					
20 PLUMBING	1.9%	116,940		2.49	
30 HVAC	3.9%	235,000		5.00	
40 FIRE PROTECTION	2.6%	159,950		3.40	
50 ELECTRICAL	3.1%	185,345		3.94	
E EQUIPMENT + FURNISHINGS	1.0%		58,800	1.25	
10 EQUIPMENT	0.8%	50,000		1.06	
20 FURNISHINGS	0.1%	8,800		0.19	
F SPECIAL CONSTRUCTION + DEMOLITION					
10 SPECIAL CONSTRUCTION					
20 SELECTIVE BUILDING DEMOLITION					
G BUILDING SITEWORK					
10 SITE PREPARATION					
20 SITE IMPROVEMENTS					
30 SITE MECHANICAL UTILITIES					
40 SITE ELECTRICAL UTILITIES					
50 OTHER SITE CONSTRUCTION					
DIRECT COSTS	100%		6,036,185	128.43	
SITE REQUIREMENTS	4.0%		241,447	5.14	
JOBSITE MANAGEMENT	4.0%		241,447	5.14	
ESTIMATE SUB-TOTAL			6,519,079	138.70	
INSURANCE + BONDING	2.0%		130,382	2.77	
FEE	4.0%		260,763	5.55	
ESTIMATE SUB-TOTAL			6,910,224	147.03	
DESIGN CONTINGENCY	10.0%		691,022	14.70	
CONSTRUCTION CONTINGENCY					Carried elsewhere
MARKET CONDITIONS FACTOR					N/A
ESTIMATE SUB-TOTAL			7,601,246	161.73	
ESCALATION 3 YEARS TO MIDPOINT	15.00%		1,140,187	24.26	
ESTIMATE TOTAL			8,741,433	185.99	

ESTIMATE DETAIL Parking Below City Hall GSF : 47,000

REF	DESCRIPTION	QUANTITY	UoM	UNIT RATE	TOTAL	COMMENTS
55	A20					
56						
57	BASEMENT CONSTRUCTION					
58						
59	Excavation					
60	Excavation	19,989	CY	12.00	239,868	
61	Ramps	2,000	CY	12.00	24,000	
62	Remove and dispose	21,989	CY	17.00	373,813	
63	Dewatering	1	LS	10,000.00	10,000	
64	Backfill to retaining walls	100	CY	35.00	3,500	
65						
66	Fill					
67	fill below ground floor		NA	15.00		
68						
69	Walling					
70	Shoring of excavation	7,200	SF	45.00	324,000	
71	Concrete walls	500	CY	290.00	145,000	
72	Formwork	27,000	SF	10.00	270,000	
73	Rebar - 200lbs/cy	100,000	LBS	1.10	110,000	
74	Pilasters	1	LS	25,000.00	25,000	
75						
76	Waterproofing					
77	Waterproofing to retaining wall	13,500	SF	9.00	121,500	
78	Waterproofing below basement SOG		NA			Allow
79						
80	Drainage					
81	Perimeter drain to wall	900	LF	30.00	27,000	
82						
83						
84						
85						
86	BASEMENT CONSTRUCTION		A20		1,673,681	\$35.61 / SF
87						
88	B10					
89						
90	SUPERSTRUCTURE					
91						
92	Columns					
93	Formwork	5,600	SF	12.00	67,200	
94	Concrete	119	CY	280.00	33,320	
95	Rebar	53,550	LBS	1.10	58,905	450LBS/CY
96						
97	Beams					
98	Internal beams					
99	Formwork	18,900	SF	13.00	245,700	
100	Concrete	380	CY	280.00	106,400	
101	Rebar	152,000	LBS	1.10	167,200	
102						
103	Perimeter upturned beams	1	LS	100,000.00	100,000	
104	Formwork					
105	Concrete					
106	Rebar					
107						

ESTIMATE DETAIL Parking Below City Hall GSF : 47,000

REF	DESCRIPTION	QUANTITY	UoM	UNIT RATE	TOTAL	COMMENTS
108	Crashwalls					
109	Internal crashwalls		NA			
110	Formwork					
111	Concrete					
112	Rebar					
113						
114	Elevated slabs					
115	Formwork	47,000	SF	12.00	564,000	
116	Concrete	1,741	CY	155.00	269,855	5"
117	Rebar	435,250	LBS	0.90	391,725	250LBS/CY
118	Expansion joint		NA			
119						
120						
121						
122	Miscellaneous Items					
123	Misc. metals					
124	General	47,000	GSF	0.50	23,500	Includes embeds
125						
126	Misc concrete items					
127	General	47,000	SF	0.25	11,750	Depressions, premium for sloped slabs, etc
128	Mechanical pads	1	LS	5,000.00	5,000	
129	Concrete curbs	944	LF	31.00	29,264	
130	Misc curbs	1,000	LF	10.00	10,000	
131	Firestopping	1	LS	5,000.00	5,000	
132						
133	SUPERSTRUCTURE		B10		2,088,819	\$44.44 / SF
134						
135	B20					
136						
137	EXTERIOR CLOSURE					
138						
139	Allow for enclosure of walling at ramps etc	1	LS	300,000.00	300,000	
140	Canopy screens etc	1	LS	100,000.00	100,000	
141						
142	EXTERIOR CLOSURE		B20		400,000	\$8.51 / SF
143						
144	B30					
145						
146	ROOFING					
147						
148	Waterproofing to podium	27,000	NA			Sitework
149	Flashing	1	LS	1,500.00	1,500	
150	Misc	1	LS	5,000.00	5,000	
151						
152	ROOFING		B30		6,500	\$0.14 / SF
153						
154	C10					
155						
156	INTERIOR CONSTRUCTION					
157						
158	Elevator core/Lobby walls, metal stud w stucco	1	LS	100,000.00	100,000	
159						
160						
161						
162	Doors					
163	Single	5	EA	2,300.00	11,500	
164						
165	Specialties					
166	Striping					
167	Parking spaces	118	EA	25.00	2,950	
168	Directional	47,000	GSF	0.15	7,050	
169	Warning	47,000	GSF	0.05	2,350	
170	Signage	1	LS	10,000.00	10,000	
171	Wheel stops	10	EA	65.00	650	ADA stalls only
172						
173	INTERIOR CONSTRUCTION		C10		134,500	\$2.86 / SF

ESTIMATE DETAIL Parking Below City Hall GSF : 47,000

REF	DESCRIPTION	QUANTITY	UoM	UNIT RATE	TOTAL	COMMENTS
174						
175	C20					
176						
177	STAIRS					
178						
179	Stair construction	1	FLT	26,000.00	26,000	
180	<i>CIP concrete includes handrails, finishes, etc</i>					
181						
182	STAIRS		C20		26,000	\$0.55 / SF
183						
184	C30					
185						
186	INTERIOR FINISHES					
187						
188	Elastomeric traffic topping		NA			
189	Paint to concrete walls/columns/beams/slabs/etc	47,000	SF	1.20	56,400	
190						
191	INTERIOR FINISHES		C30		56,400	\$1.2 / SF
192						
193	D10					
194						
195	CONVEYING					
196						
197	Passenger Elevators					
198	elevator- passenger	2	NA			with bldg above
199	Cab finishes	2	NA			
200						
201	CONVEYING		D10			\$0 / SF
202						
203	D20					
204						
205	PLUMBING					
206						
207	Sanitary fixtures		NA			
208						
209	Sanitary waste & vent piping					
210	Sand oil interceptor	1	LS	5,500.00	5,500	
211	Floor drains	10	EA	520.00	5,200	
212	Floor drains at stairs	1	EA	520.00	520	
213	Sanitary waste and vent piping	250	LF	57.00	14,250	
214						
215	Domestic cold water piping, <=2" copper "L"	300	LF	38.00	11,400	
216	Hose bibb, Level -	4	EA	250.00	1,000	
217	Water meters					See site utility
218						
219	Storm drainage					
220	Area drains	6	EA	520.00	3,120	
221	Trench drain connections	6	EA	400.00	2,400	
222	Storm piping	1,150	LF	57.00	65,550	
223						
224	Plumbing related items	1	LS	8,000.00	8,000	
225						
226	PLUMBING		D20		116,940	\$2.49 / SF
227						
228	D30					
229						
230	HVAC					
231	Allow fro ventilation only	47,000	SF	5.00	235,000	
232						
233						
234						
235						
236	HVAC		D30		235,000	\$5 / SF
237						

ESTIMATE DETAIL Parking Below City Hall GSF : 47,000

REF	DESCRIPTION	QUANTITY	UoM	UNIT RATE	TOTAL	COMMENTS
238	D40					
239						
240	FIRE PROTECTION					
241						
242	Sprinklers					
243	Automatic wet fire sprinkler / standpipe	47,000	SF	3.30	155,100	Galv.
244	BFP station	1	EA	3,200.00	3,200	
245	Fire dept connection	1	EA	1,650.00	1,650	
246						
247	FIRE PROTECTION		D40		159,950	\$3.4 / SF
248						
249	D50					
250						
251	ELECTRICAL					
252						
253	Distribution	47,000	SF	0.95	44,650	
254	Main switchboard MSB, 1200A, 480/277V					
255	480/277V panels, feeders					
256	Transformers, feeders					
257	208/1210V panels, feeders					
258	Connect elevators					
259	Cab lighting disconnects					
260	Misc connections to mechanical equipment					
261	Grounding					
262	Allowance for conduits for future parking access/revenue control system					
263	Power to coiling grilles					
264						
265	Lighting	47,000	SF	2.00	94,000	
266	1x4 fluorescent fixtures					
267	Stairwell fixtures, fluorescent					
268	Wall mounted floods					
269	Misc surface mounted fixtures					
270	LED exit lights					
273	Lighting back boxes					
274	Lighting conduit, wire					
276	Lighting controls					
277						
278	Convenience Power					
279	Duplex outlets	10	EA	380.00	3,800	
280						
281	Fire Alarm					
282	Smoke detectors	3	EA	450.00	1,350	
283	Misc devices	5	EA	430.00	2,150	
284	Connections to sprinkler system	1	LS	5,000.00	5,000	
285						
286	Security					
287	CCTV cameras, interior, fixed	4	EA	2,600.00	10,400	
288	CCTV cameras, exterior	1	EA	4,995.00	4,995	
289	CCTV control, recording	1	LS	10,000.00	10,000	Allow
290	Blue light call stations	2	EA	4,500.00	9,000	
291						
292	ELECTRICAL		D50		185,345	\$3.94 / SF
293						
294	E10					
295						
296	EQUIPMENT					
297						
298	Parking control gate etc	1	LS	50,000.00	50,000	
299						
300	EQUIPMENT		E10		50,000	\$1.06 / SF
301						

ESTIMATE DETAIL Parking Below City Hall GSF : 47,000

REF	DESCRIPTION	QUANTITY	UoM	UNIT RATE	TOTAL	COMMENTS
302	E20					
303						
304	FURNISHINGS					
305						
306	Trash cans	2	EA	650.00	1,300	
307	Bollards	10	EA	450.00	4,500	
308	Misc furnishings	1	LS	3,000.00	3,000	
309						
310	FURNISHINGS		E20		8,800	\$0.19 / SF
311						
312	F10					
313						
314	SPECIAL CONSTRUCTION					
315						
316	No work in this section					
317						
318	SPECIAL CONSTRUCTION		F10			\$0 / SF
319						
320	F20					
321						
322	SELECTIVE BUILDING DEMOLITION					
323						
324	No work in this section					
325						
326	SELECTIVE BUILDING DEMOLITION		F20			\$0 / SF
327						
328	G10					
329						
330	SITE PREPARATION					
331						
332	Site Earthwork					
333	Clear and grub site		SF	0.40		Sitework
334	Cut/fill		CY	8.00		Sitework
335	Rough and fine grading		SF	0.40		Sitework
336	Erosion control		MO	4,000.00		Sitework
337						Sitework
338	Site Demolition	1	LS	50,000.00		Sitework
339						Sitework
340	Hazardous Waste Remediation					
341	Excluded					
342						
343	SITE PREPARATION		G10			\$0 / SF
344						
345	G20					
346						
347	SITE IMPROVEMENTS					
348						
349	Asphalt & Paving					
350	Pedestrian paving	5,000	SF	12.00		Incl. edge condition
351	Repairs to adjacent road	1	LS	50,000.00		
352	Curbs	500	LF	18.00		
353						
354	Markings & Signage					
355	Site signage	1	LS	10,000.00		
356	Miscellaneous striping	1	LS	3,500.00		
357						
358	Site Furnishings					
359	Bollards	10	EA	550.00		
360	Seating elements	5	EA	1,200.00		
361	Bike racks	10	EA	500.00		
362	Fencing and gates	1	LS	5,000.00		Allow
363						

ESTIMATE DETAIL Parking Below City Hall GSF : 47,000

REF	DESCRIPTION	QUANTITY	UoM	UNIT RATE	TOTAL	COMMENTS
364	Landscaping					
365	Ground preparation	2,500	SF	6.00		
366	Thron baring shrubs	1,000	SF	5.00		
367	Shrubs and ground cover	1,000	SF	5.00		
368	Urban expression					
369	Palms	2	EA	5,500.00		20' brown trunk height
370	Planters	75	SF	150.00		1/4 of length, 3' wide
371	Trees	5	EA	325.00		24" box
372	Tree grates	7	EA	1,250.00		Including frame
373						
374	Irrigation Systems	5,000	SF	1.95		
375						
376	SITE IMPROVEMENTS		G20			\$0 / SF
377						
378	G30					
379						
380	SITE MECHANICAL UTILITIES					
381						
382	Fire					
383	Point of connection	1	EA	2000.00		
384	10" dia C900 piping	50	LF	112.00		
385	8" dia	40	LF	78.00		
386	6" dia	40	LF	65.00		
387	Fire hydrant with s/off valve	1	EA	3500.00		
388	Fire post indicator valve	1	EA	1275.00		
389	Fire department connection	1	EA	1200.00		
390	8" dia Double detector assembly valve	1	EA	9000.00		
391	Thrust block	5	EA	550.00		
392						
393	Water					
394	Point of connection	1	EA	1,200.00		
395	4" dia C900 piping	150	LF	57.00		
396	Meters, Valves & specialties	1	LS	4,000.00		
397						
398	Sanitary Sewer					
399	Remove existing Sanitary sewer	1	LS	3,500.00		
400	Point of connection	1	EA	2,200.00		
401	6" dia piping	200	LF	47.00		
402	Manhole	2	EA	3,500.00		
403	SS Cleanout	1	EA	520.00		
404						
405	Stormwater					
406	Point of connection	1	EA	2,200.00		
407	12" dia SDR 35 piping	540	LF	62.00		
408	Manhole	1	EA	3,500.00		
409	Catchbasin / "Christy inlet"	6	EA	1,100.00		
410	Catchbasin / "Bubbler box"	1	EA	350.00		
411	SD Cleanout	3	EA	1,000.00		
412	Perforated piping	120	LF	35.00		
413						
414	SITE MECHANICAL UTILITIES		G30			\$0 / SF
415						
416	G40					
417						
418	SITE ELECTRICAL UTILITIES					
419						
420	Site Electrical					
421	Splice existing 12kV conductors	2	EA	590.00		
422	New 12kV duct bank with conductors, allow 250ft	150	LF	60.80		
423	12kV terminations	2	EA	410.00		
424	Transformer pad, grounding	1	EA	2,000.00		
425	Padmount transformer, allow	1	EA	30,000.00		
426	Secondary duct bank, 1200A	100	LF	286.90		
427	Incoming communications duct bank, allow	150	LF	18.12		
428	Trenching and backfill	250	LF	23.25		
429	Concrete encase duct bank	32	CY	120.00		
430	Pavement repair	250	LF	30.00		
431						

ESTIMATE DETAIL

Parking Below City Hall

GSF : 47,000

REF	DESCRIPTION	QUANTITY	UoM	UNIT RATE	TOTAL	COMMENTS
432	SITE ELECTRICAL UTILITIES		G40			\$0 / SF
433						
434	G50					
435						
436	OTHER SITE CONSTRUCTION					
437						
438	No work in this section					
439						
440	OTHER SITE CONSTRUCTION		G50			\$0 / SF

This page intentionally left blank.

APPENDIX A - 18

Library Expansion Cost Estimate (TBD Feb 12, 2015)

- West Wing Expansion 100 seats
- West Wing Expansion 130 seats
- East Wing Expansion 100 seats
- East Wing Expansion 130 seats
- Courtyard Infill 130 seats
- 'Perch' Addition 130 seats

Library expansion Cupertino ,CA

February 12, 2015

OPTION 1 West Wing -100 seats New Construction



tbd consultants

111 Pine Street, Suite 1315
San Francisco, CA 94111
415.981.9430 phone (main)
415.981.9434 facsimile
www.tbdconsultants.com

Prepared for:
Perkins Will

San Francisco, CA

TABLE OF CONTENTS

OPTION 1 West Wing -100 seats

CONTENTS

PAGE No.

Basis of Estimate

1

Key Criteria - Areas

4

Overall Summary

5

New Construction

Cost Summary

6

Detailed Estimate

8

PROJECT DESCRIPTION

The project involves the new construction of a single story building built adjoining existing building

REFERENCE DOCUMENTATION

Documents:

Architectural Report

Dated Dec 11,2014

MEETINGS

Meeting / ongoing discussions with Architect / design team

BASIS FOR PRICING

This estimate reflects the fair construction value for this project and should not be construed as a prediction of low bid. Prices are based on local prevailing wage construction costs at the time the estimate was prepared. Pricing assumes a procurement process with competitive bidding for all sub-trades of the construction work, which is to mean a minimum of 3 bids for all subcontractors and materials/equipment suppliers. If fewer bids are solicited or received, prices can be expected to be higher.

Subcontractor's markups have been included in each line item unit price. Markups cover the cost of field overhead, home office overhead and subcontractor's profit. Subcontractor's markups typically range from 15% to 25% of the unit price depending on market conditions.

General Contractor's/Construction Manager's Site Requirement costs are calculated on a percentage basis. General Contractor's/Construction Manager's Jobsite Management costs are also calculated on a percentage

General Contractor's/Construction Manager's overhead and fees are based on a percentage of the total direct costs plus general conditions, and covers the contractor's bond, insurance, site office overheads and profit.

Unless identified otherwise, the cost of such items as overtime, shift premiums and construction phasing are not included in the line item unit price.

This cost estimate is based on standard industry practice, professional experience and knowledge of the local construction market costs. TBD Consultants have no control over the material and labor costs, contractors methods of establishing prices or the market and bidding conditions at the time of bid. Therefore TBD Consultants do not guarantee that the bids received will not vary from this cost estimate.

CONTINGENCY

Design Contingency **15%**

The Design Contingency is carried to cover scope that lacks definition and scope that is *anticipated* to be added to the Design. As the Design becomes more complete the Design Contingency will reduce.

Construction Contingency **N/A** **to be carried elsewhere in Owner's Budget**

The Construction Contingency is carried to cover the unforeseen during construction execution and Risks that do not currently have mitigation plans. As Risks are mitigated, Construction Contingency can be reduce, but should not be eliminated.

A Market Conditions Factor has not been included to reflect the current bidding climate where we should expect multiple bids for each trade. An owners contingency has not been included in this construction cost estimate, but it is advised that the owner carry additional contingency to cover scope change, claims and delays.

ESCALATION

Escalation has been included from the estimate -- see summary

EXCLUSIONS

- Land acquisition, feasibility, and financing costs
- All Owner soft costs
- All professional fees and insurance
- Construction Manager Agency Costs
- Site or existing condition survey investigation costs, including determination of subsoil conditions
- Hazardous materials inspection costs, or accommodations in construction for hazardous materials.
- Overtime, 2nd shift and lost productivity premiums - except where specifically identified
- Construction or occupancy phasing (current assumption is a single construction phase in a vacated building)
- Owners Construction Contingency for scope changes and market conditions at time of bid
- Permits

Library expansion

Cupertino, CA

New Construction
Concept Development Phase**BASIS OF ESTIMATE**OPTION 1 West Wing -100 seats

ITEMS THAT MAY AFFECT THIS ESTIMATE

Such items include, but are not limited to the following:

- Modifications to the scope of work subsequent to the preparation of this estimate

- Unforeseen existing conditions

- Compression of planned construction schedule (current assumption is approx. 6 months+ duration)

- Special requirements for site access, off-hour work or phasing activities

- Restrictive technical specifications, excessive contract or non-competitive bid conditions

- Sole source specifications for materials, products or equipment

- Bid approvals delayed beyond the anticipated project schedule

KEY CRITERIA

OPTION 1 West Wing -100 seats

AREA TABULATION

New Construction

Location	Enclosed	Perim	Height	Area	Comment
First Floor	SF 2,020	132	21.00	SF 2,772	
Second floor				-	
Third floor					
Subtotal	2,020 SF	132 SF	21.00 LF	0.00	

Covered Area @ 50% SF Allow

TOTAL	2,020 SF				
--------------	-----------------	--	--	--	--

	Opt 1 W Wing 100 Seats	Opt 1 W Wing 132 Seats	Opt 2 E Wing 100 Seats	Opt 2 E Wing 132 Seats
Program Rm	1,080	1,335	1,070	1,330
lobby	530	530	543	543
Store	160	160	180	180
Men Toilet	125	125	216	216
Wom Toilet	125	125	216	216
Total SF	2,020	2,275	2,225	2,485

Library expansion
Cupertino ,CA

New Construction
Concept Development Phase

OVERALL SUMMARY

OPTION 1 West Wing -100 seats

	GROSS FLOOR AREA	COST (\$/SF)	COST (\$'s)
New Construction	2,020	\$1,747	\$3,528,049

UNIFORMAT II SUMMARY

Gross Square Feet: 2,020

New Construction OPTION 1 West Wing -100 seats

SECTION	%	\$	\$ / SF	COMMENTS
10 FOUNDATIONS	5.3%	115,880	57.37	
20 BASEMENT CONSTRUCTION				
A SUBSTRUCTURE	5.3%	115,880	57.37	
10 SUPERSTRUCTURE	5.8%	128,050	63.39	
20 EXTERIOR CLOSURE	18.8%	412,944	204.43	
30 ROOFING	9.0%	196,830	97.44	
B SHELL	33.6%	737,824	365.26	
10 INTERIOR CONSTRUCTION	8.3%	181,800	90.00	
20 STAIRS				
30 INTERIOR FINISHES	8.3%	182,510	90.35	
C INTERIORS	16.6%	364,310	180.35	
10 CONVEYING				
20 PLUMBING	3.0%	66,660	33.00	
30 HVAC	4.6%	101,000	50.00	
40 FIRE PROTECTION	0.5%	11,110	5.50	
50 ELECTRICAL	6.2%	135,340	67.00	
D SERVICES	14.3%	314,110	155.50	
10 EQUIPMENT				
20 FURNISHINGS	0.5%	10,000	4.95	
E EQUIPMENT + FURNISHINGS	0.5%	10,000	4.95	
10 SPECIAL CONSTRUCTION				
20 SELECTIVE BUILDING DEMOLITION	1.4%	30,400	15.05	
F SPECIAL CONSTRUCTION + DEMOLITION	1.4%	30,400	15.05	
10 SITE PREPARATION	0.8%	17,310	8.57	
20 SITE IMPROVEMENTS	10.3%	225,000	111.39	
30 SITE MECHANICAL UTILITIES	3.6%	80,000	39.60	
40 SITE ELECTRICAL UTILITIES	4.6%	100,000	49.50	
50 OTHER SITE CONSTRUCTION	9.1%	200,000	99.01	
G BUILDING SITEWORK	28.4%	622,310	308.07	
DIRECT COSTS	100%	2,194,834	1,086.55	
SITE REQUIREMENTS	3.0%	65,845	32.60	
JOBSITE MANAGEMENT	8.0%	175,587	86.92	
ESTIMATE SUB-TOTAL		2,436,266	1,206.07	
INSURANCE + BONDING	2.5%	60,907	30.15	
FEE	7.0%	170,539	84.43	
ESTIMATE SUB-TOTAL		2,667,712	1,320.65	
DESIGN CONTINGENCY	15.0%	400,157	198.10	
CONSTRUCTION CONTINGENCY	N/A			Owner to carry
ESTIMATE SUB-TOTAL		3,067,869	1,518.75	
ESCALATION 3 years to mid point	15.0%	460,180	227.81	
ESTIMATE TOTAL		\$ 3,528,049	1,746.56	total add-ons 60.74%

Library expansion
Cupertino, CA

NEW CONSTRUCTION

New Construction
Concept Development Phase

New Construction

OPTION 1 West Wing -100 seats

GSF :

2,020

REF	DESCRIPTION	QUANTITY	UoM	UNIT RATE	TOTAL	COMMENTS
1						
2	FOUNDATIONS					
3						
4	Foundation allocation	2,020	SF	30.00	60,600	
5	<i>Add retaining wall next trees</i>	60	LF	450.00	27,000	
6						
7						
8	Special foundations		NA			
9						
10						
11	Slab on grade --	2,020	SF	14.00	28,280	Including curbs etc
12						
13						
14						
15	FOUNDATIONS				115,880	\$57.37 / SF
16						
17	BASEMENT CONSTRUCTION					
18						
19	NA					Storage?
20						
21						
22	BASEMENT CONSTRUCTION					\$0 / SF
23						
24	SUPERSTRUCTURE					
25						
26	Floor & Roof Construction	2,020	SF	50.00	101,000	
27						
28	<i>Steel construction</i>					
29						
30	Steel frame					
31	Structural steel moment frame					
32	Fireproofing					
33	Metal deck					
34	Floor					
35	Roof					
36	Concrete fill to metal deck, reinforced					
37	Slab edge closure					incl above
38	Form openings in deck					
39						
40	Spray fireproofing to u/side of decks		NA			
41	Curbs at plumbing walls etc	1	LS	4,000.00	4,000	
42						
43	Miscellaneous					
44						
45	Allow for miscellaneous structural supports	1	LS	10,000.00	10,000	
46	Structural supports to parapet	1	LS	8,000.00	8,000	
47	Allow for miscellaneous metals	2,020	SF	2.50	5,050	
48	Fire stopping		NA	18.00		
49						
50						
51						
52						
53	SUPERSTRUCTURE				128,050	\$63.39 / SF
54						
55	EXTERIOR CLOSURE					
56						
57	Exterior Walls					
58						
59	Above grade ext skin	2,772	SF	125.00	346,500	
60	Windows		NA			
61	Seismic joints	45	LF	220.00	9,900	
62	Soffits	1	LS	10,000.00	10,000	
63	Fins and louvers	1	LS	20,000.00	20,000	
64						

Library expansion
Cupertino ,CA

New Construction
Concept Development Phase

NEW CONSTRUCTION
OPTION 1 West Wing -100 seats

GSF : 2,020

REF	DESCRIPTION	QUANTITY	UoM	UNIT RATE	TOTAL	COMMENTS
65	Misc					
66	Caulking joints etc	2,772	SF	2.00	5,544	
67						
68						
69	Exterior Doors					
70						
71	New doors Double	1	LS	17,000.00	17,000	
72	New doors Single	1	LS	4,000.00	4,000	
73						
74						
75	EXTERIOR CLOSURE				412,944	\$204.43 / SF
76						
77	ROOFING					
78						
79	Metal sloped roofing		NA	30.00		
80						
81	Flat roofing	2,015	SF	22.00	44,330	
82	Seismic joints	70	LF	250.00	17,500	
83	New mechanical pads on roof	1	LS	5,000.00	5,000	
84						
85	Green roof	1,500	SF	40.00	60,000	
86	Roof screens	1	LS	70,000.00	70,000	
87	Skylights		NA			
88						
89	ROOFING				196,830	\$97.44 / SF
90						
91	INTERIOR CONSTRUCTION					
92						
93	Interior Partitions					
94	New interior partitions and doors and specialties	2,020	SF	90.00	181,800	
95						
96						
97						
98						
99						
100						
101						
102	INTERIOR CONSTRUCTION				181,800	\$90 / SF
103						
104	STAIRS					
105						
106	Interior stairs					
107						
108						
109						
110	New stairs main entry		NA			
111	New stairs others		NA			
112						
113						
114						
115	STAIRS					\$0 / SF
116						
117	INTERIOR FINISHES					
118						
119	Floor finishes					
120	Floor protection	2,020	SF	1.00	2,020	51,510
121						
122	Vapor retarder	2,020	SF	4.50	9,090	
123	New Flooring	2,020	SF	20.00	40,400	
124	Special flooring		NA	24.00		
125						

Library expansion
Cupertino ,CA

New Construction
Concept Development Phase

NEW CONSTRUCTION
OPTION 1 West Wing -100 seats

GSF : 2,020

REF	DESCRIPTION	QUANTITY	UoM	UNIT RATE	TOTAL	COMMENTS
126	Wall finishes					
127						
128	Painting to walls	2,020	SF	8.00	16,160	41,160
129						
130	Finishes to columns	10	EA	1,000.00	10,000	
131	Special wall finishes	1	LS	15,000.00	15,000	
132						
133	Ceiling finishes					
134						15,440
135	New AT ceiling	160	SF	9.00	1,440	
136	Drywall ceiling	250	SF	16.00	4,000	Toilets
137	Bulkheads	1	LS	10,000.00	10,000	
138	Special ceilings	1,610	SF	40.00	64,400	
139	Misc.					
140	Finishes not defined	1	LS	10,000.00	10,000	
141						
142						
143						
144						
145	INTERIOR FINISHES				182,510	\$90.35 / SF
146						
147	CONVEYING					
148						
149	New elevator and control three stops		NA			
150						
151						
152	CONVEYING					\$0 / SF
153						
154	PLUMBING					
155						
156	New plumbing system complete	2,020	SF	33.00	66,660	
157						
158						
159						
160						
161						
162						
163						
164						
165	PLUMBING				66,660	\$33 / SF
166						
167	HVAC					
168						
169	All New Mechanical system VAV air based plus reheat	2,020	SF	50.00	101,000	
170						
171						
172						
173						
174	HVAC				101,000	\$50 / SF
175						
176	FIRE PROTECTION					
177						
178	Sprinkler					
179						
180	New sprinkler system	2,020	GSF	5.50	11,110	
181						
182						
183						
184	FIRE PROTECTION				11,110	\$5.5 / SF

Library expansion
Cupertino ,CA

New Construction
Concept Development Phase

NEW CONSTRUCTION
OPTION 1 West Wing -100 seats

GSF : 2,020

New Construction

REF	DESCRIPTION	QUANTITY	UoM	UNIT RATE	TOTAL	COMMENTS
185						
186	ELECTRICAL					
187						
188	Distribution ,connections, lighting etc	2,020	SF	44.00	88,880	All new electrical system
189						
190						
191	Telephone/Data	2,020	SF	8.00	16,160	
192						
193						
194	CATV	2,020	SF	1.50	3,030	
195						
196						
197	Security Systems	2,020	SF	2.00	4,040	
198						
199						
200	Audio/Visual Systems	2,020	SF	3.00	6,060	Conduit only
201						
202	Fire Alarm	2,020	SF	3.50	7,070	
203						
204						
205	Misc. Electrical	2,020	SF	5.00	10,100	
206	Testing					
207	Seismic bracing					
208	Supervision					
209	Demolition - safe-off for demolition by others					
210	Non manual labor					
211	Misc general requirements, trucks, safety etc.					
212						
213						
214	ELECTRICAL				135,340	\$67 / SF
215						
216	EQUIPMENT					
217						
218	Eqipment allowance		NA			
219						
220						
221						
222	EQUIPMENT					\$0 / SF
223						
224	FURNISHINGS					
225						
226						
227	Casework	1	LS	10,000.00	10,000	
228						
229						
230						
231						
232	FURNISHINGS				10,000	\$4.95 / SF

Library expansion
Cupertino ,CA

NEW CONSTRUCTION

New Construction
Concept Development Phase

New Construction

OPTION 1 West Wing -100 seats

GSF :

2,020

REF	DESCRIPTION	QUANTITY	UoM	UNIT RATE	TOTAL	COMMENTS
233						
234	SPECIAL CONSTRUCTION					
235						
236	<i>No work in this section</i>					
237						
238						
239	SPECIAL CONSTRUCTION					\$0 / SF
240						
241	SELECTIVE BUILDING DEMOLITION					
242						
243	Demo existing	616	SF	25.00	15,400	and make good
244	Remedial work to adjoining building	1	LS	15,000.00	15,000	
245						
246						
247	SELECTIVE BUILDING DEMOLITION				30,400	\$15.05 / SF
248						
249	SITE PREPARATION					
250						
251	Site prep and grading	5,770	LS	3.00	17,310	
252						
253						
254						
255	SITE PREPARATION				17,310	\$8.57 / SF
256						
257	SITE IMPROVEMENTS					
258						
259	Misc. site improvements	3,750	SF	60.00	225,000	
260						
261						
262	SITE IMPROVEMENTS				225,000	\$111.39 / SF
263						
264	SITE MECHANICAL UTILITIES					
265						
266	Allowance for revisions and hook ups	1	LS	80,000.00	80,000	
267						
268						
269	SITE MECHANICAL UTILITIES				80,000	\$39.6 / SF
270						
271	SITE ELECTRICAL UTILITIES					
272						
273	Allow for electrical utilities and site lighting	1	LS	100,000.00	100,000	
274						
275						
276	SITE ELECTRICAL UTILITIES				100,000	\$49.5 / SF
277						
278	OTHER SITE CONSTRUCTION					
279						
280	<i>Moving existing utilities</i>	1	LS	200,000.00	200,000	
281						
282						
283	OTHER SITE CONSTRUCTION				200,000	\$99.01 / SF

Library expansion Cupertino ,CA

February 12, 2015

OPTION 1 West Wing -132 seats New Construction



tbd consultants

111 Pine Street, Suite 1315
San Francisco, CA 94111
415.981.9430 phone (main)
415.981.9434 facsimile
www.tbdconsultants.com

Prepared for:

Perkins Will

San Francisco, CA

TABLE OF CONTENTS

OPTION 1 West Wing -132 seats

CONTENTS	PAGE No.
Basis of Estimate	1
Key Criteria - Areas	4
Overall Summary	5
 New Construction	
Cost Summary	6
Detailed Estimate	8

PROJECT DESCRIPTION

The project involves the new construction of a single story building built adjoining existing building

REFERENCE DOCUMENTATION

Documents:

Architectural Report

Dated Dec 11,2014

MEETINGS

Meeting / ongoing discussions with Architect / design team

BASIS FOR PRICING

This estimate reflects the fair construction value for this project and should not be construed as a prediction of low bid. Prices are based on local prevailing wage construction costs at the time the estimate was prepared. Pricing assumes a procurement process with competitive bidding for all sub-trades of the construction work, which is to mean a minimum of 3 bids for all subcontractors and materials/equipment suppliers. If fewer bids are solicited or received, prices can be expected to be higher.

Subcontractor's markups have been included in each line item unit price. Markups cover the cost of field overhead, home office overhead and subcontractor's profit. Subcontractor's markups typically range from 15% to 25% of the unit price depending on market conditions.

General Contractor's/Construction Manager's Site Requirement costs are calculated on a percentage basis. General Contractor's/Construction Manager's Jobsite Management costs are also calculated on a percentage

General Contractor's/Construction Manager's overhead and fees are based on a percentage of the total direct costs plus general conditions, and covers the contractor's bond, insurance, site office overheads and profit.

Unless identified otherwise, the cost of such items as overtime, shift premiums and construction phasing are not included in the line item unit price.

This cost estimate is based on standard industry practice, professional experience and knowledge of the local construction market costs. TBD Consultants have no control over the material and labor costs, contractors methods of establishing prices or the market and bidding conditions at the time of bid. Therefore TBD Consultants do not guarantee that the bids received will not vary from this cost estimate.

CONTINGENCY

Design Contingency **15%**

The Design Contingency is carried to cover scope that lacks definition and scope that is *anticipated* to be added to the Design. As the Design becomes more complete the Design Contingency will reduce.

Construction Contingency **N/A** ***to be carried elsewhere in Owner's Budget***

The Construction Contingency is carried to cover the unforeseen during construction execution and Risks that do not currently have mitigation plans. As Risks are mitigated, Construction Contingency can be reduce, but should not be eliminated.

A Market Conditions Factor has not been included to reflect the current bidding climate where we should expect multiple bids for each trade. An owners contingency has not been included in this construction cost estimate, but it is advised that the owner carry additional contingency to cover scope change, claims and delays.

ESCALATION

Escalation has been included from the estimate -- see summary

EXCLUSIONS

- Land acquisition, feasibility, and financing costs
- All Owner soft costs
- All professional fees and insurance
- Construction Manager Agency Costs
- Site or existing condition survey investigation costs, including determination of subsoil conditions
- Hazardous materials inspection costs, or accommodations in construction for hazardous materials.
- Overtime, 2nd shift and lost productivity premiums - except where specifically identified
- Construction or occupancy phasing (current assumption is a single construction phase in a vacated building)
- Owners Construction Contingency for scope changes and market conditions at time of bid
- Permits

Library expansion

Cupertino, CA

New Construction

Concept Development Phase

BASIS OF ESTIMATE

OPTION 1 West Wing -132 seats

ITEMS THAT MAY AFFECT THIS ESTIMATE

Such items include, but are not limited to the following:

- Modifications to the scope of work subsequent to the preparation of this estimate

- Unforeseen existing conditions

- Compression of planned construction schedule (current assumption is approx. 6 months+ duration)

- Special requirements for site access, off-hour work or phasing activities

- Restrictive technical specifications, excessive contract or non-competitive bid conditions

- Sole source specifications for materials, products or equipment

- Bid approvals delayed beyond the anticipated project schedule

KEY CRITERIA

OPTION 1 West Wing -132 seats

AREA TABULATION

New Construction

Location	Enclosed	Perimeter	Height	Area	Comment
First Floor	SF 2,275	142	21.00	SF 2,982	
Second floor				-	
Third floor					
Subtotal	2,275 SF	142 SF	21.00 LF		

Covered Area @ 50% SF

TOTAL	2,275 SF
--------------	-----------------

	Opt 1 W Wing 100 Seats	Opt 1 W Wing 132 Seats	Opt 2 E Wing 100 Seats	Opt 2 E Wing 132 Seats
Program Rm	1,080	1,335	1,070	1,330
lobby	530	530	543	543
Store	160	160	180	180
Men Toilet	125	125	216	216
Wom Toilet	125	125	216	216
Total SF	2,020	2,275	2,225	2,485

Library expansion
Cupertino ,CA

New Construction
Concept Development Phase

OVERALL SUMMARY

OPTION 1 West Wing -132 seats

	GROSS FLOOR AREA	COST (\$/SF)	COST (\$'s)
New Construction	2,275	\$1,669	\$3,797,965

UNIFORMAT II SUMMARY

Gross Square Feet: 2,275

New Construction **OPTION 1 West Wing -132 seats**

SECTION	%	\$	\$ / SF	COMMENTS
10 FOUNDATIONS	5.4%	127,100	55.87	
20 BASEMENT CONSTRUCTION				
A SUBSTRUCTURE	5.4%	127,100	55.87	
10 SUPERSTRUCTURE	6.0%	141,438	62.17	
20 EXTERIOR CLOSURE	18.9%	446,614	196.31	
30 ROOFING	8.7%	205,058	90.14	
B SHELL	33.6%	793,110	348.62	
10 INTERIOR CONSTRUCTION	8.7%	204,750	90.00	
20 STAIRS				
30 INTERIOR FINISHES	9.4%	221,253	97.25	
C INTERIORS	18.0%	426,003	187.25	
10 CONVEYING				
20 PLUMBING	3.1%	72,800	32.00	
30 HVAC	4.8%	113,750	50.00	
40 FIRE PROTECTION	0.5%	12,513	5.50	
50 ELECTRICAL	6.5%	152,426	67.00	
D SERVICES	14.9%	351,489	154.50	
10 EQUIPMENT				
20 FURNISHINGS	0.4%	10,000	4.40	
E EQUIPMENT + FURNISHINGS	0.4%	10,000	4.40	
10 SPECIAL CONSTRUCTION				
20 SELECTIVE BUILDING DEMOLITION	1.3%	30,400	13.36	
F SPECIAL CONSTRUCTION + DEMOLITION	1.3%	30,400	13.36	
10 SITE PREPARATION	0.8%	18,150	7.98	
20 SITE IMPROVEMENTS	9.6%	226,500	99.56	
30 SITE MECHANICAL UTILITIES	3.4%	80,000	35.16	
40 SITE ELECTRICAL UTILITIES	4.2%	100,000	43.96	
50 OTHER SITE CONSTRUCTION	8.5%	200,000	87.91	
G BUILDING SITEWORK	26.4%	624,650	274.57	
DIRECT COSTS	100%	2,362,752	1,038.57	
SITE REQUIREMENTS	3.0%	70,883	31.16	
JOBSITE MANAGEMENT	8.0%	189,020	83.09	
ESTIMATE SUB-TOTAL		2,622,655	1,152.82	
INSURANCE + BONDING	2.5%	65,566	28.82	
FEE	7.0%	183,586	80.70	
ESTIMATE SUB-TOTAL		2,871,807	1,262.33	
DESIGN CONTINGENCY	15.0%	430,771	189.35	
CONSTRUCTION CONTINGENCY	N/A			Owner to carry
ESTIMATE SUB-TOTAL		3,302,578	1,451.68	
ESCALATION 3 years to mid point	15.0%	495,387	217.75	
ESTIMATE TOTAL		\$ 3,797,965	1,669.44	total add-ons 60.74%

Library expansion
Cupertino ,CA

NEW CONSTRUCTION

New Construction
Concept Development Phase

New Construction

OPTION 1 West Wing -132 seats

GSF :

2,275

REF	DESCRIPTION	QUANTITY	UoM	UNIT RATE	TOTAL	COMMENTS
1						
2	FOUNDATIONS					
3						
4	Foundation allocation	2,275	SF	30.00	68,250	
5	<i>Add retaining wall next trees</i>	60	LF	450.00	27,000	
6						
7						
8	Special foundations		NA			
9						
10						
11	Slab on grade --	2,275	SF	14.00	31,850	Including curbs etc
12						
13						
14						
15	FOUNDATIONS				127,100	\$55.87 / SF
16						
17	BASEMENT CONSTRUCTION					
18						
19	NA					Storage?
20						
21						
22	BASEMENT CONSTRUCTION					\$0 / SF
23						
24	SUPERSTRUCTURE					
25						
26	<u>Floor & Roof Construction</u>	2,275	SF	50.00	113,750	
27						
28	<i>Steel construction</i>					
29						
30	Steel frame					
31	Structural steel moment frame					
32	Fireproofing					
33	Metal deck					
34	Floor					
35	Roof					
36	Concrete fill to metal deck, reinforced					
37	Slab edge closure					incl above
38	Form openings in deck					
39						
40	Spray fireproofing to u/side of decks		NA			
41	Curbs at plumbing walls etc	1	LS	4,000.00	4,000	
42						
43	Miscellaneous					
44						
45	Allow for miscellaneous structural supports	1	LS	10,000.00	10,000	
46	Structural supports to parapet	1	LS	8,000.00	8,000	
47	Allow for miscellaneous metals	2,275	SF	2.50	5,688	
48	Fire stopping		NA	18.00		
49						
50						
51						
52						
53	SUPERSTRUCTURE				141,438	\$62.17 / SF
54						
55	EXTERIOR CLOSURE					
56						
57	Exterior Walls					
58						
59	Above grade ext skin	2,982	SF	125.00	372,750	
60	Windows		NA			
61	Seismic joints	45	LF	220.00	9,900	
62	Soffits	1	LS	14,000.00	14,000	
63	Fins and louvers	1	LS	24,000.00	24,000	
64						

Library expansion
Cupertino ,CA

New Construction
Concept Development Phase

NEW CONSTRUCTION
OPTION 1 West Wing -132 seats

GSF : 2,275

New Construction

REF	DESCRIPTION	QUANTITY	UoM	UNIT RATE	TOTAL	COMMENTS
65	Misc					
66	Caulking joints etc	2,982	SF	2.00	5,964	
67						
68						
69	Exterior Doors					
70						
71	New doors Double	1	LS	17,000.00	17,000	
72	New doors Single	1	LS	3,000.00	3,000	
73						
74						
75	EXTERIOR CLOSURE				446,614	\$196.31 / SF
76						
77	ROOFING					
78						
79	Metal sloped roofing		NA	30.00		
80						
81	Flat roofing	2,389	SF	22.00	52,558	
82	Seismic joints	70	LF	250.00	17,500	
83	New mechanical pad on roof	1	LS	5,000.00	5,000	
84						
85	Green roof	1,500	SF	40.00	60,000	
86	Roof screens	1	LS	70,000.00	70,000	
87	Skylights		NA			
88						
89	ROOFING				205,058	\$90.14 / SF
90						
91	INTERIOR CONSTRUCTION					
92						
93	Interior Partitions					
94	New interior partitions and doors and specialties	2,275	SF	90.00	204,750	
95						
96						
97						
98						
99						
100						
101						
102	INTERIOR CONSTRUCTION				204,750	\$90 / SF
103						
104	STAIRS					
105						
106	Interior stairs					
107						
108						
109						
110	New stairs main entry		NA			
111	New stairs others		NA			
112						
113						
114						
115	STAIRS					\$0 / SF
116						
117	INTERIOR FINISHES					
118						
119	Floor finishes					
120	Floor protection	2,275	SF	1.00	2,275	58,013
121						
122	Vapor retarder	2,275	SF	4.50	10,238	
123	New Flooring	2,275	SF	20.00	45,500	
124	Special flooring		NA	24.00		
125						

Library expansion
Cupertino, CA

NEW CONSTRUCTION

New Construction
Concept Development Phase

New Construction

OPTION 1 West Wing -132 seats

GSF :

2,275

REF	DESCRIPTION	QUANTITY	UoM	UNIT RATE	TOTAL	COMMENTS
126	Wall finishes					
127						
128	Painting to walls	2,275	SF	8.00	18,200	63,200
129	CT to bathrooms	1	LS	20,000.00	20,000	
130	Finishes to columns	10	EA	1,000.00	10,000	
131	Special wall finishes	1	LS	15,000.00	15,000	
132						
133	Ceiling finishes					
134						15,440
135	New AT ceiling	160	SF	9.00	1,440	
136	Drywall ceiling	250	SF	16.00	4,000	Toilets
137	Bulkheads	1	LS	10,000.00	10,000	
138	Special ceilings	1,865	SF	40.00	74,600	
139	Misc.					
140	Finishes not defined	1	LS	10,000.00	10,000	
141						
142						
143						
144						
145	INTERIOR FINISHES				221,253	\$97.25 / SF
146						
147	CONVEYING					
148						
149	New elevator and control three stops		NA			
150						
151						
152	CONVEYING					\$0 / SF
153						
154	PLUMBING					
155						
156	New plumbing system complete	2,275	SF	32.00	72,800	
157						
158						
159						
160						
161						
162						
163						
164						
165	PLUMBING				72,800	\$32 / SF
166						
167	HVAC					
168						
169	All New Mechanical system VAV air based plus reheat	2,275	SF	50.00	113,750	
170						
171						
172						
173						
174	HVAC				113,750	\$50 / SF
175						
176	FIRE PROTECTION					
177						
178	Sprinkler					
179						
180	New sprinkler system	2,275	GSF	5.50	12,513	
181						
182						
183						
184	FIRE PROTECTION				12,513	\$5.5 / SF

Library expansion
Cupertino ,CA

NEW CONSTRUCTION

New Construction
Concept Development Phase

New Construction

OPTION 1 West Wing -132 seats

GSF :

2,275

REF	DESCRIPTION	QUANTITY	UoM	UNIT RATE	TOTAL	COMMENTS
185						
186	ELECTRICAL					
187						
188	Distribution ,connections, lighting etc	2,275	SF	44.00	100,100	All new electrical system
189						
190						
191	Telephone/Data	2,275	SF	8.00	18,200	
192						
193						
194	CATV	2,275	SF	1.50	3,413	
195						
196						
197	Security Systems	2,275	SF	2.00	4,550	
198						
199						
200	Audio/Visual Systems	2,275	SF	3.00	6,825	Conduit only
201						
202	Fire Alarm	2,275	SF	3.50	7,963	
203						
204						
205	Misc. Electrical	2,275	SF	5.00	11,375	
206	Testing					
207	Seismic bracing					
208	Supervision					
209	Demolition - safe-off for demolition by others					
210	Non manual labor					
211	Misc general requirements, trucks, safety etc.					
212						
213						
214	ELECTRICAL				152,426	\$67 / SF
215						
216	EQUIPMENT					
217						
218	Equipment allowance		NA			
219						
220						
221						
222	EQUIPMENT					\$0 / SF
223						
224	FURNISHINGS					
225						
226						
227	Casework	1	LS	10,000.00	10,000	
228						
229						
230						
231						
232	FURNISHINGS				10,000	\$4.4 / SF
233						
234	SPECIAL CONSTRUCTION					
235						
236	<i>No work in this section</i>					
237						
238						
239	SPECIAL CONSTRUCTION					\$0 / SF
240						
241	SELECTIVE BUILDING DEMOLITION					
242						
243	Demo existing	616	SF	25.00	15,400	and make good
244	Remedial work to adjoining building	1	LS	15,000.00	15,000	
245						
246						
247	SELECTIVE BUILDING DEMOLITION				30,400	\$13.36 / SF

Library expansion
Cupertino ,CA

NEW CONSTRUCTION

New Construction
Concept Development Phase

New Construction

OPTION 1 West Wing -132 seats

GSF :

2,275

REF	DESCRIPTION	QUANTITY	UoM	UNIT RATE	TOTAL	COMMENTS
248						
249	SITE PREPARATION					
250						
251	Site prep and grading	6,050	LS	3.00	18,150	
252						
253						
254						
255	SITE PREPARATION				18,150	\$7.98 / SF
256						
257	SITE IMPROVEMENTS					
258						
259	Misc. site improvements	3,775	SF	60.00	226,500	
260						
261						
262	SITE IMPROVEMENTS				226,500	\$99.56 / SF
263						
264	SITE MECHANICAL UTILITIES					
265						
266	Allowance for revisions and hook ups	1	LS	80,000.00	80,000	
267						
268						
269	SITE MECHANICAL UTILITIES				80,000	\$35.16 / SF
270						
271	SITE ELECTRICAL UTILITIES					
272						
273	Allow for electrical utilities and site lighting	1	LS	100,000.00	100,000	
274						
275						
276	SITE ELECTRICAL UTILITIES				100,000	\$43.96 / SF
277						
278	OTHER SITE CONSTRUCTION					
279						
280	Moving existing utilities	1	LS	200,000.00	200,000	
281						
282						
283	OTHER SITE CONSTRUCTION				200,000	\$87.91 / SF

Library expansion Cupertino ,CA

February 12, 2015

OPTION 2 East Wing -100 seats New Construction



tbd consultants

111 Pine Street, Suite 1315
San Francisco, CA 94111
415.981.9430 phone (main)
415.981.9434 facsimile
www.tbdconsultants.com

Prepared for:
Perkins Will

San Francisco, CA

TABLE OF CONTENTS

OPTION 2 East Wing -100 seats

CONTENTS

PAGE No.

Basis of Estimate

1

Key Criteria - Areas

4

Overall Summary

5

New Construction

Cost Summary

6

Detailed Estimate

8

PROJECT DESCRIPTION

The project involves the new construction of a single story building built adjoining existing building

REFERENCE DOCUMENTATIONDocuments:

Architectural Report
PAE one page summary
Tipping Mar Narrative and sketches

Dated Dec 11,2014

MEETINGS

Meeting / ongoing discussions with Architect / design team

BASIS FOR PRICING

This estimate reflects the fair construction value for this project and should not be construed as a prediction of low bid. Prices are based on local prevailing wage construction costs at the time the estimate was prepared. Pricing assumes a procurement process with competitive bidding for all sub-trades of the construction work, which is to mean a minimum of 3 bids for all subcontractors and materials/equipment suppliers. If fewer bids are solicited or received, prices can be expected to be higher.

Subcontractor's markups have been included in each line item unit price. Markups cover the cost of field overhead, home office overhead and subcontractor's profit. Subcontractor's markups typically range from 15% to 25% of the unit price depending on market conditions.

General Contractor's/Construction Manager's Site Requirement costs are calculated on a percentage basis. General Contractor's/Construction Manager's Jobsite Management costs are also calculated on a percentage

General Contractor's/Construction Manager's overhead and fees are based on a percentage of the total direct costs plus general conditions, and covers the contractor's bond, insurance, site office overheads and profit.

Unless identified otherwise, the cost of such items as overtime, shift premiums and construction phasing are not included in the line item unit price.

This cost estimate is based on standard industry practice, professional experience and knowledge of the local construction market costs. TBD Consultants have no control over the material and labor costs, contractors methods of establishing prices or the market and bidding conditions at the time of bid. Therefore TBD Consultants do not guarantee that the bids received will not vary from this cost estimate.

CONTINGENCY

Design Contingency **15%**

The Design Contingency is carried to cover scope that lacks definition and scope that is *anticipated* to be added to the Design. As the Design becomes more complete the Design Contingency will reduce.

Construction Contingency **N/A** ***to be carried elsewhere in Owner's Budget***

The Construction Contingency is carried to cover the unforeseen during construction execution and Risks that do not currently have mitigation plans. As Risks are mitigated, Construction Contingency can be reduce, but should not be eliminated.

A Market Conditions Factor has not been included to reflect the current bidding climate where we should expect multiple bids for each trade. An owners contingency has not been included in this construction cost estimate, but it is advised that the owner carry additional contingency to cover scope change, claims and delays.

ESCALATION

Escalation has been included from the estimate -- see summary

EXCLUSIONS

- Land acquisition, feasibility, and financing costs
- All Owner soft costs
- All professional fees and insurance
- Construction Manager Agency Costs
- Site or existing condition survey investigation costs, including determination of subsoil conditions
- Hazardous materials inspection costs, or accommodations in construction for hazardous materials.
- Overtime, 2nd shift and lost productivity premiums - except where specifically identified
- Construction or occupancy phasing (current assumption is a single construction phase in a vacated building)
- Owners Construction Contingency for scope changes and market conditions at time of bid
- Permits

ITEMS THAT MAY AFFECT THIS ESTIMATE

Such items include, but are not limited to the following:

- Modifications to the scope of work subsequent to the preparation of this estimate

- Unforeseen existing conditions

- Compression of planned construction schedule (current assumption is approx. 6 months+ duration)

- Special requirements for site access, off-hour work or phasing activities

- Restrictive technical specifications, excessive contract or non-competitive bid conditions

- Sole source specifications for materials, products or equipment

- Bid approvals delayed beyond the anticipated project schedule

KEY CRITERIA

OPTION 2 East Wing -100 seats

AREA TABULATION

New Construction

Location	Enclosed	Perim	Height	Area	Comment
First Floor	SF 2,225	163	21.00	SF 3,423	
Second floor				-	
Third floor					
Subtotal	2,225 SF	163 SF	21.00 LF	0.00	
Covered Area @ 50%	85 SF				Allow
TOTAL	2,310 SF				

	Opt 1	Opt 1	Opt 2	Opt 2
	W Wing	W Wing	E Wing	E Wing
	100 Seats	132 Seats	100 Seats	130 Seats
Program Rm	1,080	1,335	1,070	1,330
lobby	530	530	543	543
Store	160	160	180	180
Men Toilet	125	125	216	216
Wom Toilet	125	125	216	216
Total SF	2,020	2,275	2,225	2,485

Library expansion
Cupertino ,CA

New Construction
Concept Development Phase

OVERALL SUMMARY

OPTION 2 East Wing -100 seats

	GROSS FLOOR AREA	COST (\$/SF)	COST (\$'s)
New Construction	2,310	\$1,688	\$3,899,333

UNIFORMAT II SUMMARY

Gross Square Feet: 2,310

New Construction OPTION 2 East Wing -100 seats

SECTION	%	\$	\$ / SF	COMMENTS
10 FOUNDATIONS	3.1%	74,172	32.11	
20 BASEMENT CONSTRUCTION				
A SUBSTRUCTURE	3.1%	74,172	32.11	
10 SUPERSTRUCTURE	4.8%	116,925	50.62	
20 EXTERIOR CLOSURE	21.2%	515,421	223.13	
30 ROOFING	7.5%	181,476	78.56	
B SHELL	33.5%	813,822	352.30	
10 INTERIOR CONSTRUCTION	8.3%	200,250	86.69	
20 STAIRS				
30 INTERIOR FINISHES	8.8%	212,590	92.03	
C INTERIORS	17.0%	412,840	178.72	
10 CONVEYING				
20 PLUMBING	3.1%	76,230	33.00	
30 HVAC	4.6%	111,250	48.16	
40 FIRE PROTECTION	0.5%	12,238	5.30	
50 ELECTRICAL	6.1%	149,076	64.54	
D SERVICES	14.4%	348,794	150.99	
10 EQUIPMENT				
20 FURNISHINGS	0.4%	10,000	4.33	
E EQUIPMENT + FURNISHINGS	0.4%	10,000	4.33	
10 SPECIAL CONSTRUCTION				
20 SELECTIVE BUILDING DEMOLITION	1.0%	24,180	10.47	
F SPECIAL CONSTRUCTION + DEMOLITION	1.0%	24,180	10.47	
10 SITE PREPARATION	0.8%	18,267	7.91	
20 SITE IMPROVEMENTS	11.1%	268,740	116.34	
30 SITE MECHANICAL UTILITIES	3.3%	80,000	34.63	
40 SITE ELECTRICAL UTILITIES	4.1%	100,000	43.29	
50 OTHER SITE CONSTRUCTION	11.3%	275,000	119.05	
G BUILDING SITEWORK	30.6%	742,007	321.22	
DIRECT COSTS	100%	2,425,815	1,050.14	
SITE REQUIREMENTS	3.0%	72,774	31.50	
JOBSITE MANAGEMENT	8.0%	194,065	84.01	
ESTIMATE SUB-TOTAL		2,692,654	1,165.65	
INSURANCE + BONDING	2.5%	67,316	29.14	
FEE	7.0%	188,486	81.60	
ESTIMATE SUB-TOTAL		2,948,456	1,276.39	
DESIGN CONTINGENCY	15.0%	442,268	191.46	
CONSTRUCTION CONTINGENCY	N/A			Owner to carry
ESTIMATE SUB-TOTAL		3,390,724	1,467.85	
ESCALATION 3 years to mid point	15.0%	508,609	220.18	
ESTIMATE TOTAL		\$ 3,899,333	1,688.02	total add-ons 60.74%

Library expansion
Cupertino, CA

NEW CONSTRUCTION

New Construction
Concept Development Phase

New Construction

OPTION 2 East Wing -100 seats

GSF :

2,310

REF	DESCRIPTION	QUANTITY	UoM	UNIT RATE	TOTAL	COMMENTS
1						
2	FOUNDATIONS					
3						
4	Foundation allocation	1,613	SF	30.00	48,390	Footprint
5						
6						
7						
8	Special foundations		NA			
9						
10						
11	Slab on grade --	1,613	SF	14.00	22,582	Including curbs etc
12	Existing toilets	400	SF	8.00	3,200	
13						
14						
15	FOUNDATIONS				74,172	\$32.11 / SF
16						
17	BASEMENT CONSTRUCTION					
18						
19	NA					Storage?
20						
21						
22	BASEMENT CONSTRUCTION					\$0 / SF
23						
24	SUPERSTRUCTURE					
25						
26	Floor & Roof Construction	1,783	SF	50.00	89,150	includes overhang
27						
28	Steel construction					
29						
30	Steel frame					
31	Structural steel moment frame					
32	Fireproofing					
33	Metal deck					
34	Floor					
35	Roof					
36	Concrete fill to metal deck, reinforced					
37	Slab edge closure					incl above
38	Form openings in deck					
39						
40	Spray fireproofing to u/side of decks		NA			
41	Curbs at plumbing walls etc	1	LS	4,000.00	4,000	
42						
43	Miscellaneous					
44						
45	Allow for miscellaneous structural supports	1	LS	10,000.00	10,000	
46	Structural supports to parapet	1	LS	8,000.00	8,000	
47	Allow for miscellaneous metals	2,310	SF	2.50	5,775	
48	Fire stopping		NA	18.00		
49						
50						
51						
52						
53	SUPERSTRUCTURE				116,925	\$50.62 / SF
54						
55	EXTERIOR CLOSURE					
56						
57	Exterior Walls					
58						
59	Above grade ext skin	3,423	SF	125.00	427,875	
60	Windows		NA			
61	Seismic joints	45	LF	220.00	9,900	
62	Overhang	170	SF	40.00	6,800	
62	Soffits	1	LS	10,000.00	10,000	
63	Fins and louvers	1	LS	20,000.00	20,000	

Library expansion
Cupertino ,CA

NEW CONSTRUCTION

New Construction
Concept Development Phase

New Construction

OPTION 2 East Wing -100 seats

GSF :

2,310

REF	DESCRIPTION	QUANTITY	UoM	UNIT RATE	TOTAL	COMMENTS
64						
65	Misc					
66	Caulking joints etc	3,423	SF	2.00	6,846	
67						
68						
69	Exterior Doors					
70						
71	New doors Double	2	LS	17,000.00	34,000	
72	New doors Single		NA	3,000.00		
73						
74						
75	EXTERIOR CLOSURE				515,421	\$223.13 / SF
76						
77	ROOFING					
78						
79	Metal sloped roofing		NA	30.00		
80						
81	Flat roofing	1,783	SF	22.00	39,226	
82	Seismic joints	45	LF	250.00	11,250	
83	New mechanical pads on roof	1	LS	5,000.00	5,000	
84						
85	Green roof	1,400	SF	40.00	56,000	
86	Roof screens	1	LS	70,000.00	70,000	
87	Skylights		NA			
88						
89	ROOFING				181,476	\$78.56 / SF
90						
91	INTERIOR CONSTRUCTION					
92						
93	Interior Partitions					
94	New interior partitions and doors and specialties	2,225	SF	90.00	200,250	
95						
96						
97						
98						
99						
100						
101						
102	INTERIOR CONSTRUCTION				200,250	\$86.69 / SF
103						
104	STAIRS					
105						
106	Interior stairs					
107						
108						
109						
110	New stairs main entry		NA			
111	New stairs others		NA			
112						
113						
114						
115	STAIRS					\$0 / SF
116						
117	INTERIOR FINISHES					
118						
119	Floor finishes					
120	Floor protection	2,225	SF	1.00	2,225	56,738
121						
122	Vapor retarder	2,225	SF	4.50	10,013	
123	New Flooring	2,225	SF	20.00	44,500	
124	Special flooring		NA	24.00		
125						

Library expansion
Cupertino ,CA

New Construction
Concept Development Phase

NEW CONSTRUCTION
OPTION 2 East Wing -100 seats

GSF : 2,310

New Construction

REF	DESCRIPTION	QUANTITY	UoM	UNIT RATE	TOTAL	COMMENTS
126	Wall finishes					
127						
128	Painting to walls	2,225	SF	8.00	17,800	62,800
129	CT to walls	1	LS	20,000.00	20,000	
130	Finishes to columns	10	EA	1,000.00	10,000	
131	Special wall finishes	1	LS	15,000.00	15,000	
132						
133	Ceiling finishes					
134						18,532
135	New AT ceiling	180	SF	9.00	1,620	
136	Drywall ceiling	432	SF	16.00	6,912	Toilets
137	Bulkheads	1	LS	10,000.00	10,000	
138	Special ceilings	1,613	SF	40.00	64,520	
139	Misc.					
140	Finishes not defined	1	LS	10,000.00	10,000	
141						
142						
143						
144						
145	INTERIOR FINISHES				212,590	\$92.03 / SF
146						
147	CONVEYING					
148						
149	New elevator and control three stops		NA			
150						
151						
152	CONVEYING					\$0 / SF
153						
154	PLUMBING					
155						
156	New plumbing system complete	2,310	SF	33.00	76,230	
157						
158						
159						
160						
161						
162						
163						
164						
165	PLUMBING				76,230	\$33 / SF
166						
167	HVAC					
168						
169	All New Mechanical system VAV air based plus reheat	2,225	SF	50.00	111,250	
170						
171						
172						
173						
174	HVAC				111,250	\$48.16 / SF
175						
176	FIRE PROTECTION					
177						
178	Sprinkler					
179						
180	New sprinkler system	2,225	GSF	5.50	12,238	
181						
182						
183						
184	FIRE PROTECTION				12,238	\$5.3 / SF

Library expansion
Cupertino ,CA

New Construction
Concept Development Phase

NEW CONSTRUCTION
OPTION 2 East Wing -100 seats

GSF : 2,310

New Construction

REF	DESCRIPTION	QUANTITY	UoM	UNIT RATE	TOTAL	COMMENTS
185						
186	ELECTRICAL					
187						
188	Distribution ,connections, lighting etc	2,225	SF	44.00	97,900	All new electrical system
189						
190						
191	Telephone/Data	2,225	SF	8.00	17,800	
192						
193						
194	CATV	2,225	SF	1.50	3,338	
195						
196						
197	Security Systems	2,225	SF	2.00	4,450	
198						
199						
200	Audio/Visual Systems	2,225	SF	3.00	6,675	Conduit only
201						
202	Fire Alarm	2,225	SF	3.50	7,788	
203						
204						
205	Misc. Electrical	2,225	SF	5.00	11,125	
206	Testing					
207	Seismic bracing					
208	Supervision					
209	Demolition - safe-off for demolition by others					
210	Non manual labor					
211	Misc general requirements, trucks, safety etc.					
212						
213						
214	ELECTRICAL				149,076	\$64.54 / SF
215						
216	EQUIPMENT					
217						
218	Equipment allowance		NA			
219						
220						
221						
222	EQUIPMENT					\$0 / SF
223						
224	FURNISHINGS					
225						
226						
227	Casework	1	LS	10,000.00	10,000	
228						
229						
230						
231						
232	FURNISHINGS				10,000	\$4.33 / SF

Library expansion
Cupertino ,CA

NEW CONSTRUCTION
OPTION 2 East Wing -100 seats

New Construction
Concept Development Phase

New Construction

GSF :

2,310

REF	DESCRIPTION	QUANTITY	UoM	UNIT RATE	TOTAL	COMMENTS
233						
234	SPECIAL CONSTRUCTION					
235						
236	<i>No work in this section</i>					
237						
238						
239	SPECIAL CONSTRUCTION					\$0 / SF
240						
241	SELECTIVE BUILDING DEMOLITION					
242						
243	Demo existing internal	612	SF	15.00	9,180	and make good
244	Remedial work to adjoining building	1	LS	15,000.00	15,000	
245						
246						
247	SELECTIVE BUILDING DEMOLITION				24,180	\$10.47 / SF
248						
249	SITE PREPARATION					
250						
251	Site prep and grading	6,089	LS	3.00	18,267	
252						
253						
254						
255	SITE PREPARATION				18,267	\$7.91 / SF
256						
257	SITE IMPROVEMENTS					
258						
259	Misc. site improvements	3,779	SF	60.00	226,740	
260	<i>Retaining wall</i>	70	LF	600.00	42,000	Retain soil
261						
262	SITE IMPROVEMENTS				268,740	\$116.34 / SF
263						
264	SITE MECHANICAL UTILITIES					
265						
266	Allowance for revisions and hook ups	1	LS	80,000.00	80,000	
267						
268						
269	SITE MECHANICAL UTILITIES				80,000	\$34.63 / SF
270						
271	SITE ELECTRICAL UTILITIES					
272						
273	Allow for electrical utilities and site lighting	1	LS	100,000.00	100,000	
274						
275						
276	SITE ELECTRICAL UTILITIES				100,000	\$43.29 / SF
277						
278	OTHER SITE CONSTRUCTION					
279						
280	<i>Moving existing utilities</i>	1	LS	200,000.00	200,000	
281	<i>Adding casework to existing story room</i>	1	LS	75,000.00	75,000	
282						
283	OTHER SITE CONSTRUCTION				275,000	\$119.05 / SF

Library expansion Cupertino ,CA

February 12, 2015

OPTION 2 East Wing -130 seats New Construction



tbd consultants

111 Pine Street, Suite 1315
San Francisco, CA 94111
415.981.9430 phone (main)
415.981.9434 facsimile
www.tbdconsultants.com

Prepared for:
Perkins Will

San Francisco, CA

TABLE OF CONTENTS

OPTION 2 East Wing -130 seats

CONTENTS

PAGE No.

Basis of Estimate

1

Key Criteria - Areas

4

Overall Summary

5

New Construction

Cost Summary

6

Detailed Estimate

8

PROJECT DESCRIPTION

The project involves the new construction of a single story building built adjoining existing building

REFERENCE DOCUMENTATION

Documents:

Architectural Report

Dated Dec 11,2014

PAE one page summary

Tipping Mar Narrative and sketches

MEETINGS

Meeting / ongoing discussions with Architect / design team

BASIS FOR PRICING

This estimate reflects the fair construction value for this project and should not be construed as a prediction of low bid. Prices are based on local prevailing wage construction costs at the time the estimate was prepared. Pricing assumes a procurement process with competitive bidding for all sub-trades of the construction work, which is to mean a minimum of 3 bids for all subcontractors and materials/equipment suppliers. If fewer bids are solicited or received, prices can be expected to be higher.

Subcontractor's markups have been included in each line item unit price. Markups cover the cost of field overhead, home office overhead and subcontractor's profit. Subcontractor's markups typically range from 15% to 25% of the unit price depending on market conditions.

General Contractor's/Construction Manager's Site Requirement costs are calculated on a percentage basis. General Contractor's/Construction Manager's Jobsite Management costs are also calculated on a percentage

General Contractor's/Construction Manager's overhead and fees are based on a percentage of the total direct costs plus general conditions, and covers the contractor's bond, insurance, site office overheads and profit.

Unless identified otherwise, the cost of such items as overtime, shift premiums and construction phasing are not included in the line item unit price.

This cost estimate is based on standard industry practice, professional experience and knowledge of the local construction market costs. TBD Consultants have no control over the material and labor costs, contractors methods of establishing prices or the market and bidding conditions at the time of bid. Therefore TBD Consultants do not guarantee that the bids received will not vary from this cost estimate.

CONTINGENCY

Design Contingency **15%**

The Design Contingency is carried to cover scope that lacks definition and scope that is *anticipated* to be added to the Design. As the Design becomes more complete the Design Contingency will reduce.

Construction Contingency **N/A** ***to be carried elsewhere in Owner's Budget***

The Construction Contingency is carried to cover the unforeseen during construction execution and Risks that do not currently have mitigation plans. As Risks are mitigated, Construction Contingency can be reduce, but should not be eliminated.

A Market Conditions Factor has not been included to reflect the current bidding climate where we should expect multiple bids for each trade. An owners contingency has not been included in this construction cost estimate, but it is advised that the owner carry additional contingency to cover scope change, claims and delays.

ESCALATION

Escalation has been included from the estimate -- see summary

EXCLUSIONS

- Land acquisition, feasibility, and financing costs
- All Owner soft costs
- All professional fees and insurance
- Construction Manager Agency Costs
- Site or existing condition survey investigation costs, including determination of subsoil conditions
- Hazardous materials inspection costs, or accommodations in construction for hazardous materials.
- Overtime, 2nd shift and lost productivity premiums - except where specifically identified
- Construction or occupancy phasing (current assumption is a single construction phase in a vacated building)
- Owners Construction Contingency for scope changes and market conditions at time of bid
- Permits

ITEMS THAT MAY AFFECT THIS ESTIMATE

Such items include, but are not limited to the following:

- Modifications to the scope of work subsequent to the preparation of this estimate

- Unforeseen existing conditions

- Compression of planned construction schedule (current assumption is approx. 6 months+ duration)

- Special requirements for site access, off-hour work or phasing activities

- Restrictive technical specifications, excessive contract or non-competitive bid conditions

- Sole source specifications for materials, products or equipment

- Bid approvals delayed beyond the anticipated project schedule

KEY CRITERIA

OPTION 2 East Wing -130 seats

AREA TABULATION

New Construction

Location	Enclosed	Perim	Height	Area	Comment
First Floor	SF 2,485	151	21.00	SF 3,171	
Second floor				-	
Third floor					
Subtotal	2,485 SF	151 SF	21.00 LF	0.00	
Covered Area @ 50%	85 SF				Allow
TOTAL	2,570 SF				

	Opt 1	Opt 1	Opt 2	Opt 2
	W Wing	W Wing	E Wing	E Wing
	100 Seats	132 Seats	100 Seats	130 Seats
Program Rm	1,080	1,335	1,070	1,330
lobby	530	530	543	543
Store	160	160	180	180
Men Toilet	125	125	216	216
Wom Toilet	125	125	216	216
Total SF	2,020	2,275	2,225	2,485

Library expansion
Cupertino ,CA

New Construction
Concept Development Phase

OVERALL SUMMARY

OPTION 2 East Wing -130 seats

	GROSS FLOOR AREA	COST (\$/SF)	COST (\$'s)
New Construction	2,570	\$1,556	\$3,999,515

UNIFORMAT II SUMMARY

Gross Square Feet: 2,570

New Construction **OPTION 2 East Wing -130 seats**

SECTION	%	\$	\$ / SF	COMMENTS
10 FOUNDATIONS	3.0%	74,172	28.86	
20 BASEMENT CONSTRUCTION				
A SUBSTRUCTURE	3.0%	74,172	28.86	
10 SUPERSTRUCTURE	5.2%	130,575	50.81	
20 EXTERIOR CLOSURE	19.4%	483,417	188.10	
30 ROOFING	7.5%	187,196	72.84	
B SHELL	32.2%	801,188	311.75	
10 INTERIOR CONSTRUCTION	9.0%	223,650	87.02	
20 STAIRS				
30 INTERIOR FINISHES	8.9%	221,300	86.11	
C INTERIORS	17.9%	444,950	173.13	
10 CONVEYING				
20 PLUMBING	3.4%	84,810	33.00	
30 HVAC	5.0%	124,250	48.35	
40 FIRE PROTECTION	0.5%	13,668	5.32	
50 ELECTRICAL	6.7%	166,496	64.78	
D SERVICES	15.6%	389,224	151.45	
10 EQUIPMENT				
20 FURNISHINGS	0.4%	10,000	3.89	
E EQUIPMENT + FURNISHINGS	0.4%	10,000	3.89	
10 SPECIAL CONSTRUCTION				
20 SELECTIVE BUILDING DEMOLITION	1.0%	24,180	9.41	
F SPECIAL CONSTRUCTION + DEMOLITION	1.0%	24,180	9.41	
10 SITE PREPARATION	0.8%	19,125	7.44	
20 SITE IMPROVEMENTS	10.9%	270,300	105.18	
30 SITE MECHANICAL UTILITIES	3.2%	80,000	31.13	
40 SITE ELECTRICAL UTILITIES	4.0%	100,000	38.91	
50 OTHER SITE CONSTRUCTION	11.1%	275,000	107.00	
G BUILDING SITEWORK	29.9%	744,425	289.66	
DIRECT COSTS	100%	2,488,139	968.15	
SITE REQUIREMENTS	3.0%	74,644	29.04	
JOBSITE MANAGEMENT	8.0%	199,051	77.45	
ESTIMATE SUB-TOTAL		2,761,834	1,074.64	
INSURANCE + BONDING	2.5%	69,046	26.87	
FEE	7.0%	193,328	75.22	
ESTIMATE SUB-TOTAL		3,024,208	1,176.73	
DESIGN CONTINGENCY	15.0%	453,631	176.51	
CONSTRUCTION CONTINGENCY	N/A			Owner to carry
ESTIMATE SUB-TOTAL		3,477,839	1,353.24	
ESCALATION 3 years to mid point	15.0%	521,676	202.99	
ESTIMATE TOTAL		\$ 3,999,515	1,556.23	total add-ons 60.74%

Library expansion
Cupertino, CA

NEW CONSTRUCTION

New Construction
Concept Development Phase

New Construction

OPTION 2 East Wing -130 seats

GSF :

2,570

REF	DESCRIPTION	QUANTITY	UoM	UNIT RATE	TOTAL	COMMENTS
1						
2	FOUNDATIONS					
3						
4	Foundation allocation	1,613	SF	30.00	48,390	Footprint
5						
6						
7						
8	Special foundations		NA			
9						
10						
11	Slab on grade --	1,613	SF	14.00	22,582	Including curbs etc
12	Existing toilets	400	SF	8.00	3,200	
13						
14						
15	FOUNDATIONS				74,172	\$28.86 / SF
16						
17	BASEMENT CONSTRUCTION					
18						
19	NA					Storage?
20						
21						
22	BASEMENT CONSTRUCTION					\$0 / SF
23						
24	SUPERSTRUCTURE					
25						
26	Floor & Roof Construction	2,043	SF	50.00	102,150	includes overhang
27						
28	Steel construction					
29						
30	Steel frame					
31	Structural steel moment frame					
32	Fireproofing					
33	Metal deck					
34	Floor					
35	Roof					
36	Concrete fill to metal deck, reinforced					
37	Slab edge closure					incl above
38	Form openings in deck					
39						
40	Spray fireproofing to u/side of decks		NA			
41	Curbs at plumbing walls etc	1	LS	4,000.00	4,000	
42						
43	Miscellaneous					
44						
45	Allow for miscellaneous structural supports	1	LS	10,000.00	10,000	
46	Structural supports to parapet	1	LS	8,000.00	8,000	
47	Allow for miscellaneous metals	2,570	SF	2.50	6,425	
48	Fire stopping		NA	18.00		
49						
50						
51						
52						
53	SUPERSTRUCTURE				130,575	\$50.81 / SF
54						
55	EXTERIOR CLOSURE					
56						
57	Exterior Walls					
58						
59	Above grade ext skin	3,171	SF	125.00	396,375	
60	Windows		NA			
61	Seismic joints	45	LF	220.00	9,900	
62	Overhang	170	SF	40.00	6,800	
62	Soffits	1	LS	10,000.00	10,000	
63	Fins and louvers	1	LS	20,000.00	20,000	
64						

Library expansion
Cupertino ,CA

New Construction
Concept Development Phase

NEW CONSTRUCTION
OPTION 2 East Wing -130 seats

GSF : 2,570

New Construction

REF	DESCRIPTION	QUANTITY	UoM	UNIT RATE	TOTAL	COMMENTS
65	Misc					
66	Caulking joints etc	3,171	SF	2.00	6,342	
67						
68						
69	Exterior Doors					
70						
71	New doors Double	2	LS	17,000.00	34,000	
72	New doors Single		NA	3,000.00		
73						
74						
75	EXTERIOR CLOSURE				483,417	\$188.1 / SF
76						
77	ROOFING					
78						
79	Metal sloped roofing		NA	30.00		
80						
81	Flat roofing	2,043	SF	22.00	44,946	
82	Seismic joints	45	LF	250.00	11,250	
83	New mechanical pads on roof	1	LS	5,000.00	5,000	
84						
85	Green roof	1,400	SF	40.00	56,000	
86	Roof screens	1	LS	70,000.00	70,000	
87	Skylights		NA			
88						
89	ROOFING				187,196	\$72.84 / SF
90						
91	INTERIOR CONSTRUCTION					
92						
93	Interior Partitions					
94	New interior partitions and doors and specialties	2,485	SF	90.00	223,650	
95						
96						
97						
98						
99						
100						
101						
102	INTERIOR CONSTRUCTION				223,650	\$87.02 / SF
103						
104	STAIRS					
105						
106	Interior stairs					
107						
108						
109						
110	New stairs main entry		NA			
111	New stairs others		NA			
112						
113						
114						
115	STAIRS					\$0 / SF
116						
117	INTERIOR FINISHES					
118						
119	Floor finishes					
120	Floor protection	2,485	SF	1.00	2,485	63,368
121						
122	Vapor retarder	2,485	SF	4.50	11,183	
123	New Flooring	2,485	SF	20.00	49,700	
124	Special flooring		NA	24.00		
125						

Library expansion
Cupertino ,CA

NEW CONSTRUCTION

New Construction
Concept Development Phase

New Construction

OPTION 2 East Wing -130 seats

GSF :

2,570

REF	DESCRIPTION	QUANTITY	UoM	UNIT RATE	TOTAL	COMMENTS
126	Wall finishes					
127						
128	Painting to walls	2,485	SF	8.00	19,880	64,880
129	CT to walls	1	LS	20,000.00	20,000	
130	Finishes to columns	10	EA	1,000.00	10,000	
131	Special wall finishes	1	LS	15,000.00	15,000	
132						
133	Ceiling finishes					
134						18,532
135	New AT ceiling	180	SF	9.00	1,620	
136	Drywall ceiling	432	SF	16.00	6,912	Toilets
137	Bulkheads	1	LS	10,000.00	10,000	
138	Special ceilings	1,613	SF	40.00	64,520	
139	Misc.					
140	Finishes not defined	1	LS	10,000.00	10,000	
141						
142						
143						
144						
145	INTERIOR FINISHES				221,300	\$86.11 / SF
146						
147	CONVEYING					
148						
149	New elevator and control three stops		NA			
150						
151						
152	CONVEYING					\$0 / SF
153						
154	PLUMBING					
155						
156	New plumbing system complete	2,570	SF	33.00	84,810	
157						
158						
159						
160						
161						
162						
163						
164						
165	PLUMBING				84,810	\$33 / SF
166						
167	HVAC					
168						
169	All New Mechanical system VAV air based plus reheat	2,485	SF	50.00	124,250	
170						
171						
172						
173						
174	HVAC				124,250	\$48.35 / SF
175						
176	FIRE PROTECTION					
177						
178	Sprinkler					
179						
180	New sprinkler system	2,485	GSF	5.50	13,668	
181						
182						
183						
184	FIRE PROTECTION				13,668	\$5.32 / SF

Library expansion
Cupertino ,CA

NEW CONSTRUCTION

New Construction
Concept Development Phase

New Construction

OPTION 2 East Wing -130 seats

GSF :

2,570

REF	DESCRIPTION	QUANTITY	UoM	UNIT RATE	TOTAL	COMMENTS
185						
186	ELECTRICAL					
187						
188	Distribution ,connections, lighting etc	2,485	SF	44.00	109,340	All new electrical system
189						
190						
191	Telephone/Data	2,485	SF	8.00	19,880	
192						
193						
194	CATV	2,485	SF	1.50	3,728	
195						
196						
197	Security Systems	2,485	SF	2.00	4,970	
198						
199						
200	Audio/Visual Systems	2,485	SF	3.00	7,455	Conduit only
201						
202	Fire Alarm	2,485	SF	3.50	8,698	
203						
204						
205	Misc. Electrical	2,485	SF	5.00	12,425	
206	Testing					
207	Seismic bracing					
208	Supervision					
209	Demolition - safe-off for demolition by others					
210	Non manual labor					
211	Misc general requirements, trucks, safety etc.					
212						
213						
214	ELECTRICAL				166,496	\$64.78 / SF
215						
216	EQUIPMENT					
217						
218	Equipment allowance		NA			
219						
220						
221						
222	EQUIPMENT					\$0 / SF
223						
224	FURNISHINGS					
225						
226						
227	Casework	1	LS	10,000.00	10,000	
228						
229						
230						
231						
232	FURNISHINGS				10,000	\$3.89 / SF

Library expansion
Cupertino, CA

NEW CONSTRUCTION
OPTION 2 East Wing -130 seats

New Construction
Concept Development Phase

New Construction

GSF :

2,570

REF	DESCRIPTION	QUANTITY	UoM	UNIT RATE	TOTAL	COMMENTS
233						
234	SPECIAL CONSTRUCTION					
235						
236	<i>No work in this section</i>					
237						
238						
239	SPECIAL CONSTRUCTION					\$0 / SF
240						
241	SELECTIVE BUILDING DEMOLITION					
242						
243	Demo existing internal	612	SF	15.00	9,180	and make good
244	Remedial work to adjoining building	1	LS	15,000.00	15,000	
245						
246						
247	SELECTIVE BUILDING DEMOLITION				24,180	\$9.41 / SF
248						
249	SITE PREPARATION					
250						
251	Site prep and grading	6,375	LS	3.00	19,125	
252						
253						
254						
255	SITE PREPARATION				19,125	\$7.44 / SF
256						
257	SITE IMPROVEMENTS					
258						
259	Misc. site improvements	3,805	SF	60.00	228,300	
260	<i>Retaining wall</i>	70	LF	600.00	42,000	
261						
262	SITE IMPROVEMENTS				270,300	\$105.18 / SF
263						
264	SITE MECHANICAL UTILITIES					
265						
266	Allowance for revisions and hook ups	1	LS	80,000.00	80,000	
267						
268						
269	SITE MECHANICAL UTILITIES				80,000	\$31.13 / SF
270						
271	SITE ELECTRICAL UTILITIES					
272						
273	Allow for electrical utilities and site lighting	1	LS	100,000.00	100,000	
274						
275						
276	SITE ELECTRICAL UTILITIES				100,000	\$38.91 / SF
277						
278	OTHER SITE CONSTRUCTION					
279						
280	<i>Moving existing utilities</i>	1	LS	200,000.00	200,000	
281	<i>Adding csework to existing story room</i>	1	LS	75,000.00	75,000	
282						
283	OTHER SITE CONSTRUCTION				275,000	\$107 / SF

Library expansion Cupertino ,CA

February 12, 2015

OPTION 3 Courtyard -130 seats New Construction



tbd consultants

111 Pine Street, Suite 1315
San Francisco, CA 94111
415.981.9430 phone (main)
415.981.9434 facsimile
www.tbdconsultants.com

Prepared for:
Perkins Will

San Francisco, CA

TABLE OF CONTENTS

OPTION 3 Courtyard -130 seats

CONTENTS

PAGE No.

Basis of Estimate

1

Key Criteria - Areas

4

Overall Summary

5

New Construction

Cost Summary

6

Detailed Estimate

8

PROJECT DESCRIPTION

The project involves the new construction of a single story building built adjoining existing building

REFERENCE DOCUMENTATIONDocuments:

Architectural Report

Dated Dec 11,2014

PAE one page summary

Tipping Mar Narrative and sketches

MEETINGS

Meeting / ongoing discussions with Architect / design team

BASIS FOR PRICING

This estimate reflects the fair construction value for this project and should not be construed as a prediction of low bid. Prices are based on local prevailing wage construction costs at the time the estimate was prepared. Pricing assumes a procurement process with competitive bidding for all sub-trades of the construction work, which is to mean a minimum of 3 bids for all subcontractors and materials/equipment suppliers. If fewer bids are solicited or received, prices can be expected to be higher.

Subcontractor's markups have been included in each line item unit price. Markups cover the cost of field overhead, home office overhead and subcontractor's profit. Subcontractor's markups typically range from 15% to 25% of the unit price depending on market conditions.

General Contractor's/Construction Manager's Site Requirement costs are calculated on a percentage basis. General Contractor's/Construction Manager's Jobsite Management costs are also calculated on a percentage

General Contractor's/Construction Manager's overhead and fees are based on a percentage of the total direct costs plus general conditions, and covers the contractor's bond, insurance, site office overheads and profit.

Unless identified otherwise, the cost of such items as overtime, shift premiums and construction phasing are not included in the line item unit price.

This cost estimate is based on standard industry practice, professional experience and knowledge of the local construction market costs. TBD Consultants have no control over the material and labor costs, contractors methods of establishing prices or the market and bidding conditions at the time of bid. Therefore TBD Consultants do not guarantee that the bids received will not vary from this cost estimate.

CONTINGENCY

Design Contingency **15%**

The Design Contingency is carried to cover scope that lacks definition and scope that is *anticipated* to be added to the Design. As the Design becomes more complete the Design Contingency will reduce.

Construction Contingency **N/A** ***to be carried elsewhere in Owner's Budget***

The Construction Contingency is carried to cover the unforeseen during construction execution and Risks that do not currently have mitigation plans. As Risks are mitigated, Construction Contingency can be reduce, but should not be eliminated.

A Market Conditions Factor has not been included to reflect the current bidding climate where we should expect multiple bids for each trade. An owners contingency has not been included in this construction cost estimate, but it is advised that the owner carry additional contingency to cover scope change, claims and delays.

ESCALATION

Escalation has been included from the estimate -- see summary

EXCLUSIONS

- Land acquisition, feasibility, and financing costs
- All Owner soft costs
- All professional fees and insurance
- Construction Manager Agency Costs
- Site or existing condition survey investigation costs, including determination of subsoil conditions
- Hazardous materials inspection costs, or accommodations in construction for hazardous materials.
- Overtime, 2nd shift and lost productivity premiums - except where specifically identified
- Construction or occupancy phasing (current assumption is a single construction phase in a vacated building)
- Owners Construction Contingency for scope changes and market conditions at time of bid
- Permits

ITEMS THAT MAY AFFECT THIS ESTIMATE

Such items include, but are not limited to the following:

- Modifications to the scope of work subsequent to the preparation of this estimate

- Unforeseen existing conditions

- Compression of planned construction schedule (current assumption is approx. 6 months+ duration)

- Special requirements for site access, off-hour work or phasing activities

- Restrictive technical specifications, excessive contract or non-competitive bid conditions

- Sole source specifications for materials, products or equipment

- Bid approvals delayed beyond the anticipated project schedule

KEY CRITERIA

OPTION 3 Courtyard -130 seats

AREA TABULATION

New Construction

Location	Enclosed	Perim	Height	Area	Comment
First Floor	SF 3,790	32	21.00	SF 672	
Second floor				-	
Third floor					
Subtotal	3,790 SF	32 SF	21.00 LF	0.00	
Covered Area @ 50%	SF				Allow
TOTAL	3,790 SF				

	Opt 1	Opt 1	Opt 2	Opt 2	Opt 3
	W Wing	W Wing	E Wing	E Wing	Courtyard
	100 Seats	132 Seats	100 Seats	130 Seats	132 Seats
Program					
Rm	1,080	1,335	1,070	1,330	1,930
lobby	530	530	543	543	640
Store	160	160	180	180	190
Men Toilet	125	125	216	216	240
Wom Toilet	125	125	216	216	240
Hallway					550
Total SF	2,020	2,275	2,225	2,485	3,790

Library expansion
Cupertino ,CA

New Construction
Concept Development Phase

OVERALL SUMMARY

OPTION 3 Courtyard -130 seats

	GROSS FLOOR AREA	COST (\$/SF)	COST (\$'s)
New Construction	3,790	\$1,191	\$4,512,545

UNIFORMAT II SUMMARY

Gross Square Feet: 3,790

New Construction

OPTION 3 Courtyard -130 seats

SECTION	%	\$	\$ / SF	COMMENTS
10 FOUNDATIONS	5.4%	150,690	39.76	
20 BASEMENT CONSTRUCTION				
A SUBSTRUCTURE	5.4%	150,690	39.76	
10 SUPERSTRUCTURE	8.2%	230,225	60.75	
20 EXTERIOR CLOSURE	10.5%	294,344	77.66	
30 ROOFING	15.7%	441,340	116.45	
B SHELL	34.4%	965,909	254.86	
10 INTERIOR CONSTRUCTION	8.8%	246,350	65.00	
20 STAIRS				
30 INTERIOR FINISHES	11.3%	317,325	83.73	
C INTERIORS	20.1%	563,675	148.73	
10 CONVEYING				
20 PLUMBING	3.2%	90,000	23.75	
30 HVAC	6.8%	189,500	50.00	
40 FIRE PROTECTION	0.7%	20,845	5.50	
50 ELECTRICAL	9.0%	253,930	67.00	
D SERVICES	19.7%	554,275	146.25	
10 EQUIPMENT				
20 FURNISHINGS	0.4%	10,000	2.64	
E EQUIPMENT + FURNISHINGS	0.4%	10,000	2.64	
10 SPECIAL CONSTRUCTION				
20 SELECTIVE BUILDING DEMOLITION	1.1%	31,800	8.39	
F SPECIAL CONSTRUCTION + DEMOLITION	1.1%	31,800	8.39	
10 SITE PREPARATION	2.2%	60,800	16.04	
20 SITE IMPROVEMENTS	9.4%	265,150	69.96	
30 SITE MECHANICAL UTILITIES	2.8%	80,000	21.11	
40 SITE ELECTRICAL UTILITIES	3.6%	100,000	26.39	
50 OTHER SITE CONSTRUCTION	0.9%	25,000	6.60	
G BUILDING SITEWORK	18.9%	530,950	140.09	
DIRECT COSTS	100%	2,807,299	740.71	
SITE REQUIREMENTS	3.0%	84,219	22.22	
JOBSITE MANAGEMENT	8.0%	224,584	59.26	
ESTIMATE SUB-TOTAL		3,116,102	822.19	
INSURANCE + BONDING	2.5%	77,903	20.55	
FEE	7.0%	218,127	57.55	
ESTIMATE SUB-TOTAL		3,412,132	900.30	
DESIGN CONTINGENCY	15.0%	511,820	135.04	
CONSTRUCTION CONTINGENCY	N/A			Owner to carry
ESTIMATE SUB-TOTAL		3,923,952	1,035.34	
ESCALATION 3 years to mid point	15.0%	588,593	155.30	
ESTIMATE TOTAL		\$ 4,512,545	1,190.65	total add-ons 60.74%

Library expansion
Cupertino ,CA

NEW CONSTRUCTION

New Construction
Concept Development Phase

New Construction

OPTION 3 Courtyard -130 seats

GSF :

3,790

REF	DESCRIPTION	QUANTITY	UoM	UNIT RATE	TOTAL	COMMENTS
1						
2	FOUNDATIONS					
3						
4	Foundation allocation	2,670	SF	35.00	93,450	Footprint
5						
6						
7						
8	Special foundations		NA			
9						
10						
11	Slab on grade --	2,670	SF	20.00	53,400	Including curbs etc
12	Existing toilets	480	SF	8.00	3,840	
13						
14						
15	FOUNDATIONS				150,690	\$39.76 / SF
16						
17	BASEMENT CONSTRUCTION					
18						
19	NA					Storage?
20						
21						
22	BASEMENT CONSTRUCTION					\$0 / SF
23						
24	SUPERSTRUCTURE					
25						
26	Floor & Roof Construction	2,670	SF	65.00	173,550	includes overhang
27	Overhang	360	SF	70.00	25,200	
28	Steel construction					
29						
30	Steel frame					
31	Structural steel moment frame					
32	Fireproofing					
33	Metal deck					
34	Floor					
35	Roof					
36	Concrete fill to metal deck, reinforced					
37	Slab edge closure					incl above
38	Form openings in deck					
39						
40	Spray fireproofing to u/side of decks		NA			
41	Curbs at plumbing walls etc	1	LS	4,000.00	4,000	
42						
43	Miscellaneous					
44						
45	Allow for miscellaneous structural supports	1	LS	10,000.00	10,000	
46	Structural supports to parapet	1	LS	8,000.00	8,000	
47	Allow for miscellaneous metals	3,790	SF	2.50	9,475	
48	Fire stopping		NA	18.00		
49						
50						
51						
52						
53	SUPERSTRUCTURE				230,225	\$60.75 / SF
54						
55	EXTERIOR CLOSURE					
56						
57	Exterior Walls					
58						
59	Above grade ext skin	672	SF	150.00	100,800	Ext Skin
60	Int perimeter	2,910	SF	50.00	145,500	
61	Seismic joints	45	LF	220.00	9,900	
62	Overhang	170	SF	40.00	6,800	
62	Soffits	1	LS	10,000.00	10,000	
63	Fins and louvers		NA			
64						

Library expansion
Cupertino ,CA

New Construction
Concept Development Phase

New Construction

NEW CONSTRUCTION
OPTION 3 Courtyard -130 seats

GSF :

3,790

REF	DESCRIPTION	QUANTITY	UoM	UNIT RATE	TOTAL	COMMENTS
65	Misc					
66	Caulking joints etc	672	SF	2.00	1,344	
67						
68						
69	Exterior Doors					
70						
71	New doors Double	1	LS	20,000.00	20,000	
72	New doors Single		NA			
73						
74						
75	EXTERIOR CLOSURE				294,344	\$77.66 / SF
76						
77	ROOFING					
78						
79	Metal sloped roofing		NA	30.00		
80	Flat roofing canopy	360	SF	35.00	12,600	Canopy
81	Flat roofing	2,670	SF	22.00	58,740	
82	Seismic joints	200	LF	250.00	50,000	
83	New mechanical pads on roof	1	LS	5,000.00	5,000	
84						
85	Green roof	2,000	SF	40.00	80,000	
86	Roof screens	1	LS	70,000.00	70,000	
87	Skylights	1,100	SF	150.00	165,000	
88						
89	ROOFING				441,340	\$116.45 / SF
90						
91	INTERIOR CONSTRUCTION					
92						
93	Interior Partitions					
94	New interior partitions and doors and specialties	3,790	SF	65.00	246,350	
95						
96						
97						
98						
99						
100						
101						
102	INTERIOR CONSTRUCTION				246,350	\$65 / SF
103						
104	STAIRS					
105						
106	Interior stairs					
107						
108						
109						
110	New stairs main entry		NA			
111	New stairs others		NA			
112						
113						
114						
115	STAIRS					\$0 / SF
116						
117	INTERIOR FINISHES					
118						
119	Floor finishes					
120	Floor protection	3,790	SF	1.00	3,790	91,605
121						
122	Vapor retarder	2,670	SF	4.50	12,015	
123	New Flooring	3,790	SF	20.00	75,800	
124	Special flooring		NA	24.00		
125						

Library expansion
Cupertino ,CA

NEW CONSTRUCTION

New Construction
Concept Development Phase

New Construction

OPTION 3 Courtyard -130 seats

GSF :

3,790

REF	DESCRIPTION	QUANTITY	UoM	UNIT RATE	TOTAL	COMMENTS
126	Wall finishes					
127						
128	Painting to walls	3,790	SF	7.00	26,530	71,530
129	CT to walls	1	LS	20,000.00	20,000	
130	Finishes to columns	10	EA	1,000.00	10,000	
131	Special wall finishes	1	LS	15,000.00	15,000	
132						
133	Ceiling finishes					
134						19,390
135	New AT ceiling	190	SF	9.00	1,710	
136	Drywall ceiling	480	SF	16.00	7,680	Toilets
137	Bulkheads	1	LS	10,000.00	10,000	
138	Special ceilings	3,120	SF	40.00	124,800	
139	Misc.					
140	Finishes not defined	1	LS	10,000.00	10,000	
141						
142						
143						
144						
145	INTERIOR FINISHES				317,325	\$83.73 / SF
146						
147	CONVEYING					
148						
149	New elevator and control three stops		NA			
150						
151						
152	CONVEYING					\$0 / SF
153						
154	PLUMBING					
155						
156	New plumbing system complete	1	LS	90,000.00	90,000	
157						
158						
159						
160						
161						
162						
163						
164						
165	PLUMBING				90,000	\$23.75 / SF
166						
167	HVAC					
168						
169	All New Mechanical system VAV air based plus reheat	3,790	SF	50.00	189,500	
170						
171						
172						
173						
174	HVAC				189,500	\$50 / SF
175						
176	FIRE PROTECTION					
177						
178	Sprinkler					
179						
180	New sprinkler system	3,790	GSF	5.50	20,845	
181						
182						
183						
184	FIRE PROTECTION				20,845	\$5.5 / SF

Library expansion
Cupertino ,CA

NEW CONSTRUCTION

New Construction
Concept Development Phase

New Construction

OPTION 3 Courtyard -130 seats

GSF :

3,790

REF	DESCRIPTION	QUANTITY	UoM	UNIT RATE	TOTAL	COMMENTS
185						
186	ELECTRICAL					
187						
188	Distribution ,connections, lighting etc	3,790	SF	44.00	166,760	All new electrical system
189						
190						
191	Telephone/Data	3,790	SF	8.00	30,320	
192						
193						
194	CATV	3,790	SF	1.50	5,685	
195						
196						
197	Security Systems	3,790	SF	2.00	7,580	
198						
199						
200	Audio/Visual Systems	3,790	SF	3.00	11,370	Conduit only
201						
202	Fire Alarm	3,790	SF	3.50	13,265	
203						
204						
205	Misc. Electrical	3,790	SF	5.00	18,950	
206	Testing					
207	Seismic bracing					
208	Supervision					
209	Demolition - safe-off for demolition by others					
210	Non manual labor					
211	Misc general requirements, trucks, safety etc.					
212						
213						
214	ELECTRICAL				253,930	\$67 / SF
215						
216	EQUIPMENT					
217						
218	Equipment allowance		NA			
219						
220						
221						
222	EQUIPMENT					\$0 / SF
223						
224	FURNISHINGS					
225						
226						
227	Casework	1	LS	10,000.00	10,000	
228						
229						
230						
231						
232	FURNISHINGS				10,000	\$2.64 / SF

Library expansion
Cupertino, CA

NEW CONSTRUCTION

New Construction
Concept Development Phase

New Construction

OPTION 3 Courtyard -130 seats

GSF :

3,790

REF	DESCRIPTION	QUANTITY	UoM	UNIT RATE	TOTAL	COMMENTS
233						
234	SPECIAL CONSTRUCTION					
235						
236	<i>No work in this section</i>					
237						
238						
239	SPECIAL CONSTRUCTION					\$0 / SF
240						
241	SELECTIVE BUILDING DEMOLITION					
242						
243	Demo existing internal	1,120	SF	15.00	16,800	and make good
244	Remedial work to existing building	1	LS	15,000.00	15,000	
245						
246						
247	SELECTIVE BUILDING DEMOLITION				31,800	\$8.39 / SF
248						
249	SITE PREPARATION					
250						
251	Site prep and grading	1	LS	20,000.00	20,000	
252	Demo int courtyard	3,400	SF	12.00	40,800	
253						
254						
255	SITE PREPARATION				60,800	\$16.04 / SF
256						
257	SITE IMPROVEMENTS					
258						
259	Misc. site improvements	1	LS	225,000.00	225,000	
260	<i>Int courtyard</i>	730	SF	55.00	40,150	
261						
262	SITE IMPROVEMENTS				265,150	\$69.96 / SF
263						
264	SITE MECHANICAL UTILITIES					
265						
266	Allowance for revisions and hook ups	1	LS	80,000.00	80,000	
267						
268						
269	SITE MECHANICAL UTILITIES				80,000	\$21.11 / SF
270						
271	SITE ELECTRICAL UTILITIES					
272						
273	Allow for electrical utilities and site lighting	1	LS	100,000.00	100,000	
274						
275						
276	SITE ELECTRICAL UTILITIES				100,000	\$26.39 / SF
277						
278	OTHER SITE CONSTRUCTION					
279						
280	<i>Moving existing utilities</i>	1	NA	200,000.00		
281	<i>Utilities in courtyard</i>	1	LS	25,000.00	25,000	
282						
283	OTHER SITE CONSTRUCTION				25,000	\$6.6 / SF

Library expansion Cupertino ,CA

February 12, 2015

OPTION 4 Perch -130 seats New Construction



tbd consultants

111 Pine Street, Suite 1315
San Francisco, CA 94111
415.981.9430 phone (main)
415.981.9434 facsimile
www.tbdconsultants.com

Prepared for:
Perkins Will

San Francisco, CA

TABLE OF CONTENTS

OPTION 4 Perch -130 seats

CONTENTS

PAGE No.

Basis of Estimate

1

Key Criteria - Areas

4

Overall Summary

5

New Construction

Cost Summary

6

Detailed Estimate

8

Unless identified otherwise, the cost of such items as overtime, shift premiums and construction phasing are not included in the line item unit price.

This cost estimate is based on standard industry practice, professional experience and knowledge of the local construction market costs. TBD Consultants have no control over the material and labor costs, contractors methods of establishing prices or the market and bidding conditions at the time of bid. Therefore TBD Consultants do not guarantee that the bids received will not vary from this cost estimate.

CONTINGENCY

Design Contingency **15%**

The Design Contingency is carried to cover scope that lacks definition and scope that is *anticipated* to be added to the Design. As the Design becomes more complete the Design Contingency will reduce.

Construction Contingency **N/A** ***to be carried elsewhere in Owner's Budget***

The Construction Contingency is carried to cover the unforeseen during construction execution and Risks that do not currently have mitigation plans. As Risks are mitigated, Construction Contingency can be reduce, but should not be eliminated.

A Market Conditions Factor has not been included to reflect the current bidding climate where we should expect multiple bids for each trade. An owners contingency has not been included in this construction cost estimate, but it is advised that the owner carry additional contingency to cover scope change, claims and delays.

ESCALATION

Escalation has been included from the estimate -- see summary

EXCLUSIONS

- Land acquisition, feasibility, and financing costs
- All Owner soft costs
- All professional fees and insurance
- Construction Manager Agency Costs
- Site or existing condition survey investigation costs, including determination of subsoil conditions
- Hazardous materials inspection costs, or accommodations in construction for hazardous materials.
- Overtime, 2nd shift and lost productivity premiums - except where specifically identified
- Construction or occupancy phasing (current assumption is a single construction phase in a vacated building)
- Owners Construction Contingency for scope changes and market conditions at time of bid
- Permits

Library expansion

Cupertino ,CA

New Construction

Concept Development Phase

BASIS OF ESTIMATE

OPTION 4 Perch -130 seats

ITEMS THAT MAY AFFECT THIS ESTIMATE

Such items include, but are not limited to the following:

- Modifications to the scope of work subsequent to the preparation of this estimate

- Unforeseen existing conditions

- Compression of planned construction schedule (current assumption is approx. 6 months+ duration)

- Special requirements for site access, off-hour work or phasing activities

- Restrictive technical specifications, excessive contract or non-competitive bid conditions

- Sole source specifications for materials, products or equipment

- Bid approvals delayed beyond the anticipated project schedule

KEY CRITERIA

OPTION 4 Perch -130 seats

AREA TABULATION

New Construction

Location	Enclosed	Perim	Height	Area	Comment
First Floor	SF 1,400	147	15.00	SF 2,205	
Second floor	2,816	240	18.00	4,320	
Third floor					
Subtotal	4,216 SF	387 SF	33.00 LF	4,320.00	
Covered Area @ 50%	200 SF				Allow
TOTAL	4,416 SF				

	Opt 1 W Wing 100 Seats	Opt 1 W Wing 132 Seats	Opt 2 E Wing 100 Seats	Opt 2 E Wing 130 Seats	Opt 3 Courtyard 132 Seats	Opt 4 Perch 130 seats
Program Rm	1,080	1,335	1,070	1,330	1,930	1500
lobby	530	530	543	543	640	760
lobby upper						770
Store	160	160	180	180	190	150
Men Toilet	125	125	216	216	240	240
Wom Toilet	125	125	216	216	240	240
Hallway					550	
Stair						450
Total SF	2,020	2,275	2,225	2,485	3,790	4,110

Library expansion
Cupertino ,CA

New Construction
Concept Development Phase

OVERALL SUMMARY

OPTION 4 Perch -130 seats

	GROSS FLOOR AREA	COST (\$/SF)	COST (\$'s)
New Construction	4,416	\$1,177	\$5,197,311

UNIFORMAT II SUMMARY

Gross Square Feet: 4,416

New Construction

OPTION 4 Perch -130 seats

SECTION	%	\$	\$ / SF	COMMENTS
10 FOUNDATIONS	3.6%	114,840	26.01	
20 BASEMENT CONSTRUCTION				
A SUBSTRUCTURE	3.6%	114,840	26.01	
10 SUPERSTRUCTURE	11.3%	364,240	82.48	
20 EXTERIOR CLOSURE	19.6%	633,140	143.37	
30 ROOFING	8.3%	266,952	60.45	
B SHELL	39.1%	1,264,332	286.31	
10 INTERIOR CONSTRUCTION	8.5%	274,040	62.06	
20 STAIRS	0.9%	30,000	6.79	
30 INTERIOR FINISHES	10.0%	323,628	73.29	
C INTERIORS	19.4%	627,668	142.13	
10 CONVEYING	4.0%	130,000	29.44	
20 PLUMBING	3.1%	100,000	22.64	
30 HVAC	6.5%	210,800	47.74	
40 FIRE PROTECTION	0.7%	23,188	5.25	
50 ELECTRICAL	8.7%	282,472	63.97	
D SERVICES	23.1%	746,460	169.04	
10 EQUIPMENT				
20 FURNISHINGS	0.3%	10,000	2.26	
E EQUIPMENT + FURNISHINGS	0.3%	10,000	2.26	
10 SPECIAL CONSTRUCTION				
20 SELECTIVE BUILDING DEMOLITION	1.1%	35,000	7.93	
F SPECIAL CONSTRUCTION + DEMOLITION	1.1%	35,000	7.93	
10 SITE PREPARATION	0.6%	20,000	4.53	
20 SITE IMPROVEMENTS	7.3%	235,000	53.22	
30 SITE MECHANICAL UTILITIES	2.5%	80,000	18.12	
40 SITE ELECTRICAL UTILITIES	3.1%	100,000	22.64	
50 OTHER SITE CONSTRUCTION				
G BUILDING SITEWORK	13.5%	435,000	98.51	
DIRECT COSTS	100%	3,233,300	732.18	
SITE REQUIREMENTS	3.0%	96,999	21.97	
JOBSITE MANAGEMENT	8.0%	258,664	58.57	
ESTIMATE SUB-TOTAL		3,588,963	812.72	
INSURANCE + BONDING	2.5%	89,724	20.32	
FEE	7.0%	251,227	56.89	
ESTIMATE SUB-TOTAL		3,929,914	889.93	
DESIGN CONTINGENCY	15.0%	589,487	133.49	
CONSTRUCTION CONTINGENCY	N/A			Owner to carry
ESTIMATE SUB-TOTAL		4,519,401	1,023.42	
ESCALATION 3 years to mid point	15.0%	677,910	153.51	
ESTIMATE TOTAL		\$ 5,197,311	1,176.93	total add-ons 60.74%

Library expansion
Cupertino, CA

NEW CONSTRUCTION

New Construction
Concept Development Phase

New Construction

OPTION 4 Perch -130 seats

GSF :

4,416

REF	DESCRIPTION	QUANTITY	UoM	UNIT RATE	TOTAL	COMMENTS
1						
2	FOUNDATIONS					
3						
4	Foundation allocation	1,800	SF	35.00	63,000	Footprint
5						
6						
7						
8	Special foundations		NA			
9						
10	Elevator pit	1	LS	20,000.00	20,000	
11	Slab on grade --	1,400	SF	20.00	28,000	Including curbs etc
12	Existing toilets	480	SF	8.00	3,840	
13						
14						
15	FOUNDATIONS				114,840	\$26.01 / SF
16						
17	BASEMENT CONSTRUCTION					
18						
19	NA					Storage?
20						
21						
22	BASEMENT CONSTRUCTION					\$0 / SF
23						
24	SUPERSTRUCTURE					
25						
26	Floor & Roof Construction	4,416	SF	75.00	331,200	includes overhang
27	Overhang		NA			
28	Steel construction					
29						
30	Steel frame					
31	Structural steel moment frame					
32	Fireproofing					
33	Metal deck					
34	Floor					
35	Roof					
36	Concrete fill to metal deck, reinforced					
37	Slab edge closure					incl above
38	Form openings in deck					
39						
40	Spray fireproofing to u/side of decks		NA			
41	Curbs at plumbing walls etc	1	LS	4,000.00	4,000	
42						
43	Miscellaneous					
44						
45	Allow for miscellaneous structural supports	1	LS	10,000.00	10,000	
46	Structural supports to parapet	1	LS	8,000.00	8,000	
47	Allow for miscellaneous metals	4,416	SF	2.50	11,040	
48	Fire stopping		NA	18.00		
49						
50						
51						
52						
53	SUPERSTRUCTURE				364,240	\$82.48 / SF
54						
55	EXTERIOR CLOSURE					
56						
57	Exterior Walls					
58						
59	Above grade ext skin	4,320	SF	130.00	561,600	Ext Skin
60	Int perimeter		NA			
61	Seismic joints	45	LF	220.00	9,900	
62	Overhang	400	SF	40.00	16,000	
62	Soffits	1	LS	20,000.00	20,000	
63	Fins and louvers		NA			
64						

Library expansion
Cupertino ,CA

NEW CONSTRUCTION

New Construction
Concept Development Phase

New Construction

OPTION 4 Perch -130 seats

GSF :

4,416

REF	DESCRIPTION	QUANTITY	UoM	UNIT RATE	TOTAL	COMMENTS
65	Misc					
66	Caulking joints etc	4,320	SF	2.00	8,640	
67						
68						
69	Exterior Doors					
70						
71	New doors Double	1	LS	17,000.00	17,000	
72	New doors Single		NA			
73						
74						
75	EXTERIOR CLOSURE				633,140	\$143.37 / SF
76						
77	ROOFING					
78						
79	Metal sloped roofing		NA	30.00		
80	Flat roofing canopy		SF	35.00		Canopy
81	Flat roofing	2,816	SF	22.00	61,952	
82	Seismic jointsnext existing roof	1	LS	50,000.00	50,000	
83	New mechanical pads on roof	1	LS	5,000.00	5,000	
84						
85	Green roof	2,000	SF	40.00	80,000	
86	Roof screens	1	LS	70,000.00	70,000	
87	Skylights		NA	150.00		
88						
89	ROOFING				266,952	\$60.45 / SF
90						
91	INTERIOR CONSTRUCTION					
92						
93	Interior Partitions					
94	New interior partitions and doors and specialties	4,216	SF	65.00	274,040	
95						
96						
97						
98						
99						
100						
101						
102	INTERIOR CONSTRUCTION				274,040	\$62.06 / SF
103						
104	STAIRS					
105						
106	Interior stairs					
107						
108						
109						
110	New stairs main entry		NA			
111	New stairs others	1	FLT	30,000.00	30,000	
112						
113						
114						
115	STAIRS				30,000	\$6.79 / SF
116						
117	INTERIOR FINISHES					
118						
119	Floor finishes					
120	Floor protection	4,216	SF	1.00	4,216	94,836
121						
122	Vapor retarder	1,400	SF	4.50	6,300	
123	New Flooring	4,216	SF	20.00	84,320	
124	Special flooring		NA	24.00		
125						

Library expansion
Cupertino ,CA

NEW CONSTRUCTION

New Construction
Concept Development Phase

New Construction

OPTION 4 Perch -130 seats

GSF :

4,416

REF	DESCRIPTION	QUANTITY	UoM	UNIT RATE	TOTAL	COMMENTS
126	Wall finishes					
127						
128	Painting to walls	4,216	SF	7.00	29,512	74,512
129	CT to walls	1	LS	20,000.00	20,000	
130	Finishes to columns	10	EA	1,000.00	10,000	
131	Special wall finishes	1	LS	15,000.00	15,000	
132						
133	Ceiling finishes					
134						23,080
135	New AT ceiling	600	SF	9.00	5,400	
136	Drywall ceiling	480	SF	16.00	7,680	Toilets
137	Bulkheads	1	LS	10,000.00	10,000	
138	Special ceilings	3,030	SF	40.00	121,200	
139	Misc.					
140	Finishes not defined	1	LS	10,000.00	10,000	
141						
142						
143						
144						
145	INTERIOR FINISHES				323,628	\$73.29 / SF
146						
147	CONVEYING					
148						
149	New elevator and control two stops	1	LS	130,000.00	130,000	
150						
151						
152	CONVEYING				130,000	\$29.44 / SF
153						
154	PLUMBING					
155						
156	New plumbing system complete	1	LS	100,000.00	100,000	
157						
158						
159						
160						
161						
162						
163						
164						
165	PLUMBING				100,000	\$22.64 / SF
166						
167	HVAC					
168						
169	All New Mechanical system VAV air based plus reheat	4,216	SF	50.00	210,800	
170						
171						
172						
173						
174	HVAC				210,800	\$47.74 / SF
175						
176	FIRE PROTECTION					
177						
178	Sprinkler					
179						
180	New sprinkler system	4,216	GSF	5.50	23,188	
181						
182						
183						
184	FIRE PROTECTION				23,188	\$5.25 / SF

Library expansion
Cupertino ,CA

NEW CONSTRUCTION

New Construction
Concept Development Phase

New Construction

OPTION 4 Perch -130 seats

GSF :

4,416

REF	DESCRIPTION	QUANTITY	UoM	UNIT RATE	TOTAL	COMMENTS
185						
186	ELECTRICAL					
187						
188	Distribution ,connections, lighting etc	4,216	SF	44.00	185,504	All new electrical system
189						
190						
191	Telephone/Data	4,216	SF	8.00	33,728	
192						
193						
194	CATV	4,216	SF	1.50	6,324	
195						
196						
197	Security Systems	4,216	SF	2.00	8,432	
198						
199						
200	Audio/Visual Systems	4,216	SF	3.00	12,648	Conduit only
201						
202	Fire Alarm	4,216	SF	3.50	14,756	
203						
204						
205	Misc. Electrical	4,216	SF	5.00	21,080	
206	Testing					
207	Seismic bracing					
208	Supervision					
209	Demolition - safe-off for demolition by others					
210	Non manual labor					
211	Misc general requirements, trucks, safety etc.					
212						
213						
214	ELECTRICAL				282,472	\$63.97 / SF
215						
216	EQUIPMENT					
217						
218	Equipment allowance		NA			
219						
220						
221						
222	EQUIPMENT					\$0 / SF
223						
224	FURNISHINGS					
225						
226						
227	Casework	1	LS	10,000.00	10,000	
228						
229						
230						
231						
232	FURNISHINGS				10,000	\$2.26 / SF

Library expansion
Cupertino, CA

NEW CONSTRUCTION

New Construction
Concept Development Phase

New Construction

OPTION 4 Perch -130 seats

GSF :

4,416

REF	DESCRIPTION	QUANTITY	UoM	UNIT RATE	TOTAL	COMMENTS
233						
234	SPECIAL CONSTRUCTION					
235						
236	<i>No work in this section</i>					
237						
238						
239	SPECIAL CONSTRUCTION				\$0 / SF	
240						
241	SELECTIVE BUILDING DEMOLITION					
242						
243	Demo existing roof	1	LS	10,000.00	10,000	and make good
244	Remedial work to existing building	1	LS	15,000.00	15,000	
245	Demo parapets	1	LS	10,000.00	10,000	
246						
247	SELECTIVE BUILDING DEMOLITION				35,000	\$7.93 / SF
248						
249	SITE PREPARATION					
250						
251	Site prep and grading	1	LS	20,000.00	20,000	
252	Demo int courtyard		NA			
253						
254						
255	SITE PREPARATION				20,000	\$4.53 / SF
256						
257	SITE IMPROVEMENTS					
258						
259	Misc. site improvements	1	LS	225,000.00	225,000	
260	<i>Int courtyard</i>	1	LS	10,000.00	10,000	
261						
262	SITE IMPROVEMENTS				235,000	\$53.22 / SF
263						
264	SITE MECHANICAL UTILITIES					
265						
266	Allowance for revisions and hook ups	1	LS	80,000.00	80,000	
267						
268						
269	SITE MECHANICAL UTILITIES				80,000	\$18.12 / SF
270						
271	SITE ELECTRICAL UTILITIES					
272						
273	Allow for electrical utilities and site lighting	1	LS	100,000.00	100,000	
274						
275						
276	SITE ELECTRICAL UTILITIES				100,000	\$22.64 / SF
277						
278	OTHER SITE CONSTRUCTION					
279						
280	<i>Moving existing utilities</i>	1	NA	200,000.00		
281	<i>Utilities in courtyard</i>		NA			
282						
283	OTHER SITE CONSTRUCTION					\$0 / SF

Library expansion Cupertino ,CA

February 12, 2015

OPTION 2 East Wing -130 seats New Construction



tbd consultants

111 Pine Street, Suite 1315
San Francisco, CA 94111
415.981.9430 phone (main)
415.981.9434 facsimile
www.tbdconsultants.com

Prepared for:
Perkins Will

San Francisco, CA

TABLE OF CONTENTS

OPTION 2 East Wing -130 seats

CONTENTS	PAGE No.
Basis of Estimate	1
Key Criteria - Areas	4
Overall Summary	5
 New Construction	
Cost Summary	6
Detailed Estimate	8

PROJECT DESCRIPTION

The project involves the new construction of a single story building built adjoining existing building

REFERENCE DOCUMENTATIONDocuments:

Architectural Report

Dated Dec 11,2014

PAE one page summary

Tipping Mar Narrative and sketches

MEETINGS

Meeting / ongoing discussions with Architect / design team

BASIS FOR PRICING

This estimate reflects the fair construction value for this project and should not be construed as a prediction of low bid. Prices are based on local prevailing wage construction costs at the time the estimate was prepared. Pricing assumes a procurement process with competitive bidding for all sub-trades of the construction work, which is to mean a minimum of 3 bids for all subcontractors and materials/equipment suppliers. If fewer bids are solicited or received, prices can be expected to be higher.

Subcontractor's markups have been included in each line item unit price. Markups cover the cost of field overhead, home office overhead and subcontractor's profit. Subcontractor's markups typically range from 15% to 25% of the unit price depending on market conditions.

General Contractor's/Construction Manager's Site Requirement costs are calculated on a percentage basis. General Contractor's/Construction Manager's Jobsite Management costs are also calculated on a percentage

General Contractor's/Construction Manager's overhead and fees are based on a percentage of the total direct costs plus general conditions, and covers the contractor's bond, insurance, site office overheads and profit.

Unless identified otherwise, the cost of such items as overtime, shift premiums and construction phasing are not included in the line item unit price.

This cost estimate is based on standard industry practice, professional experience and knowledge of the local construction market costs. TBD Consultants have no control over the material and labor costs, contractors methods of establishing prices or the market and bidding conditions at the time of bid. Therefore TBD Consultants do not guarantee that the bids received will not vary from this cost estimate.

CONTINGENCY

Design Contingency **15%**

The Design Contingency is carried to cover scope that lacks definition and scope that is *anticipated* to be added to the Design. As the Design becomes more complete the Design Contingency will reduce.

Construction Contingency **N/A** ***to be carried elsewhere in Owner's Budget***

The Construction Contingency is carried to cover the unforeseen during construction execution and Risks that do not currently have mitigation plans. As Risks are mitigated, Construction Contingency can be reduce, but should not be eliminated.

A Market Conditions Factor has not been included to reflect the current bidding climate where we should expect multiple bids for each trade. An owners contingency has not been included in this construction cost estimate, but it is advised that the owner carry additional contingency to cover scope change, claims and delays.

ESCALATION

Escalation has been included from the estimate -- see summary

EXCLUSIONS

- Land acquisition, feasibility, and financing costs
- All Owner soft costs
- All professional fees and insurance
- Construction Manager Agency Costs
- Site or existing condition survey investigation costs, including determination of subsoil conditions
- Hazardous materials inspection costs, or accommodations in construction for hazardous materials.
- Overtime, 2nd shift and lost productivity premiums - except where specifically identified
- Construction or occupancy phasing (current assumption is a single construction phase in a vacated building)
- Owners Construction Contingency for scope changes and market conditions at time of bid
- Permits

ITEMS THAT MAY AFFECT THIS ESTIMATE

Such items include, but are not limited to the following:

Modifications to the scope of work subsequent to the preparation of this estimate

Unforeseen existing conditions

Compression of planned construction schedule (current assumption is approx. 6 months+ duration)

Special requirements for site access, off-hour work or phasing activities

Restrictive technical specifications, excessive contract or non-competitive bid conditions

Sole source specifications for materials, products or equipment

Bid approvals delayed beyond the anticipated project schedule

KEY CRITERIA

OPTION 2 East Wing -130 seats

AREA TABULATION

New Construction

Location	Enclosed	Perim	Height	Area	Comment
First Floor	SF 2,485	151	21.00	SF 3,171	
Second floor				-	
Third floor					
Subtotal	2,485 SF	151 SF	21.00 LF	0.00	
Covered Area @ 50%	85 SF				Allow
TOTAL	2,570 SF				

	Opt 1	Opt 1	Opt 2	Opt 2
	W Wing	W Wing	E Wing	E Wing
	100 Seats	132 Seats	100 Seats	130 Seats
Program Rm	1,080	1,335	1,070	1,330
lobby	530	530	543	543
Store	160	160	180	180
Men Toilet	125	125	216	216
Wom Toilet	125	125	216	216
Total SF	2,020	2,275	2,225	2,485

Library expansion
Cupertino ,CA

New Construction
Concept Development Phase

OVERALL SUMMARY

OPTION 2 East Wing -130 seats

	GROSS FLOOR AREA	COST (\$/SF)	COST (\$'s)
New Construction	2,570	\$1,556	\$3,999,515

UNIFORMAT II SUMMARY

Gross Square Feet: 2,570

New Construction OPTION 2 East Wing -130 seats

SECTION	%	\$	\$ / SF	COMMENTS
10 FOUNDATIONS	3.0%	74,172	28.86	
20 BASEMENT CONSTRUCTION				
A SUBSTRUCTURE	3.0%	74,172	28.86	
10 SUPERSTRUCTURE	5.2%	130,575	50.81	
20 EXTERIOR CLOSURE	19.4%	483,417	188.10	
30 ROOFING	7.5%	187,196	72.84	
B SHELL	32.2%	801,188	311.75	
10 INTERIOR CONSTRUCTION	9.0%	223,650	87.02	
20 STAIRS				
30 INTERIOR FINISHES	8.9%	221,300	86.11	
C INTERIORS	17.9%	444,950	173.13	
10 CONVEYING				
20 PLUMBING	3.4%	84,810	33.00	
30 HVAC	5.0%	124,250	48.35	
40 FIRE PROTECTION	0.5%	13,668	5.32	
50 ELECTRICAL	6.7%	166,496	64.78	
D SERVICES	15.6%	389,224	151.45	
10 EQUIPMENT				
20 FURNISHINGS	0.4%	10,000	3.89	
E EQUIPMENT + FURNISHINGS	0.4%	10,000	3.89	
10 SPECIAL CONSTRUCTION				
20 SELECTIVE BUILDING DEMOLITION	1.0%	24,180	9.41	
F SPECIAL CONSTRUCTION + DEMOLITION	1.0%	24,180	9.41	
10 SITE PREPARATION	0.8%	19,125	7.44	
20 SITE IMPROVEMENTS	10.9%	270,300	105.18	
30 SITE MECHANICAL UTILITIES	3.2%	80,000	31.13	
40 SITE ELECTRICAL UTILITIES	4.0%	100,000	38.91	
50 OTHER SITE CONSTRUCTION	11.1%	275,000	107.00	
G BUILDING SITEWORK	29.9%	744,425	289.66	
DIRECT COSTS	100%	2,488,139	968.15	
SITE REQUIREMENTS	3.0%	74,644	29.04	
JOBSITE MANAGEMENT	8.0%	199,051	77.45	
ESTIMATE SUB-TOTAL		2,761,834	1,074.64	
INSURANCE + BONDING	2.5%	69,046	26.87	
FEE	7.0%	193,328	75.22	
ESTIMATE SUB-TOTAL		3,024,208	1,176.73	
DESIGN CONTINGENCY	15.0%	453,631	176.51	
CONSTRUCTION CONTINGENCY	N/A			Owner to carry
ESTIMATE SUB-TOTAL		3,477,839	1,353.24	
ESCALATION 3 years to mid point	15.0%	521,676	202.99	
ESTIMATE TOTAL		\$ 3,999,515	1,556.23	total add-ons 60.74%

Library expansion
Cupertino, CA

NEW CONSTRUCTION

New Construction
Concept Development Phase

New Construction

OPTION 2 East Wing -130 seats

GSF :

2,570

REF	DESCRIPTION	QUANTITY	UoM	UNIT RATE	TOTAL	COMMENTS
1						
2	FOUNDATIONS					
3						
4	Foundation allocation	1,613	SF	30.00	48,390	Footprint
5						
6						
7						
8	Special foundations		NA			
9						
10						
11	Slab on grade --	1,613	SF	14.00	22,582	Including curbs etc
12	Existing toilets	400	SF	8.00	3,200	
13						
14						
15	FOUNDATIONS				74,172	\$28.86 / SF
16						
17	BASEMENT CONSTRUCTION					
18						
19	NA					Storage?
20						
21						
22	BASEMENT CONSTRUCTION					\$0 / SF
23						
24	SUPERSTRUCTURE					
25						
26	Floor & Roof Construction	2,043	SF	50.00	102,150	includes overhang
27						
28	Steel construction					
29						
30	Steel frame					
31	Structural steel moment frame					
32	Fireproofing					
33	Metal deck					
34	Floor					
35	Roof					
36	Concrete fill to metal deck, reinforced					
37	Slab edge closure					incl above
38	Form openings in deck					
39						
40	Spray fireproofing to u/side of decks		NA			
41	Curbs at plumbing walls etc	1	LS	4,000.00	4,000	
42						
43	Miscellaneous					
44						
45	Allow for miscellaneous structural supports	1	LS	10,000.00	10,000	
46	Structural supports to parapet	1	LS	8,000.00	8,000	
47	Allow for miscellaneous metals	2,570	SF	2.50	6,425	
48	Fire stopping		NA	18.00		
49						
50						
51						
52						
53	SUPERSTRUCTURE				130,575	\$50.81 / SF
54						
55	EXTERIOR CLOSURE					
56						
57	Exterior Walls					
58						
59	Above grade ext skin	3,171	SF	125.00	396,375	
60	Windows		NA			
61	Seismic joints	45	LF	220.00	9,900	
62	Overhang	170	SF	40.00	6,800	
62	Soffits	1	LS	10,000.00	10,000	
63	Fins and louvers	1	LS	20,000.00	20,000	
64						

Library expansion
Cupertino ,CA

New Construction
Concept Development Phase

NEW CONSTRUCTION
OPTION 2 East Wing -130 seats

GSF : 2,570

New Construction

REF	DESCRIPTION	QUANTITY	UoM	UNIT RATE	TOTAL	COMMENTS
65	Misc					
66	Caulking joints etc	3,171	SF	2.00	6,342	
67						
68						
69	Exterior Doors					
70						
71	New doors Double	2	LS	17,000.00	34,000	
72	New doors Single		NA	3,000.00		
73						
74						
75	EXTERIOR CLOSURE				483,417	\$188.1 / SF
76						
77	ROOFING					
78						
79	Metal sloped roofing		NA	30.00		
80						
81	Flat roofing	2,043	SF	22.00	44,946	
82	Seismic joints	45	LF	250.00	11,250	
83	New mechanical pads on roof	1	LS	5,000.00	5,000	
84						
85	Green roof	1,400	SF	40.00	56,000	
86	Roof screens	1	LS	70,000.00	70,000	
87	Skylights		NA			
88						
89	ROOFING				187,196	\$72.84 / SF
90						
91	INTERIOR CONSTRUCTION					
92						
93	Interior Partitions					
94	New interior partitions and doors and specialties	2,485	SF	90.00	223,650	
95						
96						
97						
98						
99						
100						
101						
102	INTERIOR CONSTRUCTION				223,650	\$87.02 / SF
103						
104	STAIRS					
105						
106	Interior stairs					
107						
108						
109						
110	New stairs main entry		NA			
111	New stairs others		NA			
112						
113						
114						
115	STAIRS					\$0 / SF
116						
117	INTERIOR FINISHES					
118						
119	Floor finishes					
120	Floor protection	2,485	SF	1.00	2,485	63,368
121						
122	Vapor retarder	2,485	SF	4.50	11,183	
123	New Flooring	2,485	SF	20.00	49,700	
124	Special flooring		NA	24.00		
125						

Library expansion
Cupertino ,CA

New Construction
Concept Development Phase

New Construction

NEW CONSTRUCTION
OPTION 2 East Wing -130 seats

GSF :

2,570

REF	DESCRIPTION	QUANTITY	UoM	UNIT RATE	TOTAL	COMMENTS
126	Wall finishes					
127						
128	Painting to walls	2,485	SF	8.00	19,880	64,880
129	CT to walls	1	LS	20,000.00	20,000	
130	Finishes to columns	10	EA	1,000.00	10,000	
131	Special wall finishes	1	LS	15,000.00	15,000	
132						
133	Ceiling finishes					
134						18,532
135	New AT ceiling	180	SF	9.00	1,620	
136	Drywall ceiling	432	SF	16.00	6,912	Toilets
137	Bulkheads	1	LS	10,000.00	10,000	
138	Special ceilings	1,613	SF	40.00	64,520	
139	Misc.					
140	Finishes not defined	1	LS	10,000.00	10,000	
141						
142						
143						
144						
145	INTERIOR FINISHES				221,300	\$86.11 / SF
146						
147	CONVEYING					
148						
149	New elevator and control three stops		NA			
150						
151						
152	CONVEYING					\$0 / SF
153						
154	PLUMBING					
155						
156	New plumbing system complete	2,570	SF	33.00	84,810	
157						
158						
159						
160						
161						
162						
163						
164						
165	PLUMBING				84,810	\$33 / SF
166						
167	HVAC					
168						
169	All New Mechanical system VAV air based plus reheat	2,485	SF	50.00	124,250	
170						
171						
172						
173						
174	HVAC				124,250	\$48.35 / SF
175						
176	FIRE PROTECTION					
177						
178	Sprinkler					
179						
180	New sprinkler system	2,485	GSF	5.50	13,668	
181						
182						
183						
184	FIRE PROTECTION				13,668	\$5.32 / SF

Library expansion
Cupertino ,CA

NEW CONSTRUCTION

New Construction
Concept Development Phase

New Construction

OPTION 2 East Wing -130 seats

GSF :

2,570

REF	DESCRIPTION	QUANTITY	UoM	UNIT RATE	TOTAL	COMMENTS
185						
186	ELECTRICAL					
187						
188	Distribution ,connections, lighting etc	2,485	SF	44.00	109,340	All new electrical system
189						
190						
191	Telephone/Data	2,485	SF	8.00	19,880	
192						
193						
194	CATV	2,485	SF	1.50	3,728	
195						
196						
197	Security Systems	2,485	SF	2.00	4,970	
198						
199						
200	Audio/Visual Systems	2,485	SF	3.00	7,455	Conduit only
201						
202	Fire Alarm	2,485	SF	3.50	8,698	
203						
204						
205	Misc. Electrical	2,485	SF	5.00	12,425	
206	Testing					
207	Seismic bracing					
208	Supervision					
209	Demolition - safe-off for demolition by others					
210	Non manual labor					
211	Misc general requirements, trucks, safety etc.					
212						
213						
214	ELECTRICAL				166,496	\$64.78 / SF
215						
216	EQUIPMENT					
217						
218	Equipment allowance		NA			
219						
220						
221						
222	EQUIPMENT					\$0 / SF
223						
224	FURNISHINGS					
225						
226						
227	Casework	1	LS	10,000.00	10,000	
228						
229						
230						
231						
232	FURNISHINGS				10,000	\$3.89 / SF

Library expansion
Cupertino, CA

NEW CONSTRUCTION
OPTION 2 East Wing -130 seats

New Construction
Concept Development Phase

New Construction

GSF :

2,570

REF	DESCRIPTION	QUANTITY	UoM	UNIT RATE	TOTAL	COMMENTS
233						
234	SPECIAL CONSTRUCTION					
235						
236	<i>No work in this section</i>					
237						
238						
239	SPECIAL CONSTRUCTION					\$0 / SF
240						
241	SELECTIVE BUILDING DEMOLITION					
242						
243	Demo existing internal	612	SF	15.00	9,180	and make good
244	Remedial work to adjoining building	1	LS	15,000.00	15,000	
245						
246						
247	SELECTIVE BUILDING DEMOLITION				24,180	\$9.41 / SF
248						
249	SITE PREPARATION					
250						
251	Site prep and grading	6,375	LS	3.00	19,125	
252						
253						
254						
255	SITE PREPARATION				19,125	\$7.44 / SF
256						
257	SITE IMPROVEMENTS					
258						
259	Misc. site improvements	3,805	SF	60.00	228,300	
260	<i>Retaining wall</i>	70	LF	600.00	42,000	
261						
262	SITE IMPROVEMENTS				270,300	\$105.18 / SF
263						
264	SITE MECHANICAL UTILITIES					
265						
266	Allowance for revisions and hook ups	1	LS	80,000.00	80,000	
267						
268						
269	SITE MECHANICAL UTILITIES				80,000	\$31.13 / SF
270						
271	SITE ELECTRICAL UTILITIES					
272						
273	Allow for electrical utilities and site lighting	1	LS	100,000.00	100,000	
274						
275						
276	SITE ELECTRICAL UTILITIES				100,000	\$38.91 / SF
277						
278	OTHER SITE CONSTRUCTION					
279						
280	<i>Moving existing utilities</i>	1	LS	200,000.00	200,000	
281	<i>Adding csework to existing story room</i>	1	LS	75,000.00	75,000	
282						
283	OTHER SITE CONSTRUCTION				275,000	\$107 / SF

This page intentionally left blank.

This page intentionally left blank.

APPENDIX A - 19

CCMP Added Surface Parking Cost Estimate
(TBD, April 24, 2015)

Cupertino Civic Center Masterplan

Added Surface Parking

Cupertino CA

OPTION 3

DG OPTION

Concept Cost Estimate

April 24, 2015

Prepared By:



111 Pine Street, Suite 1315
San Francisco, CA 94111
415.981.9430 phone (main)
415.981.9434 facsimile
www.tbdconsultants.com

Prepared for:

Perkins Will
2 Bryant Street
San Francisco, CA

TABLE OF CONTENTS

SECTION	PAGE NUMBER
BASIS OF ESTIMATE	3
KEY CRITERIA	6
OVERALL SUMMARY	7
UNIFORMAT II SUMMARY	8
ESTIMATE DETAIL	9

BASIS OF ESTIMATE

PROJECT DESCRIPTION

This project involves added surface parking (partof library field)

REFERENCE DOCUMENTATION

This Construction Cost Estimate was produced from the following documentation by International Parking Design and engineering changes occurring subsequent to the issue of these documents have not been incorporated in this estimate.

Document

- Site paln Dated Mar 2,2015
-

BASIS FOR PRICING

This estimate reflects the fair construction value for this project and should not be construed as a prediction of low bid. Prices are based on local prevailing wage construction costs at the time the estimate was prepared. Pricing assumes a procurement process with competitive bidding for all sub-trades of the construction work, which is to mean a minimum of 3 bids for all subcontractors and materials/equipment suppliers. If fewer bids are solicited or received, prices can be expected to be higher.

Subcontractor's markups have been included in each line item unit price. Markups cover the cost of field overhead, home office overhead and subcontractor's profit. Subcontractor's markups typically range from 15% to 25% of the unit price depending on market conditions.

General Contractor's/Construction Manager's Site Requirement costs are calculated on a percentage basis. General Contractor's/Construction Manager's Jobsite Management costs are also calculated on a percentage basis.

General Contractor's/Construction Manager's overhead and fees are based on a percentage of the total direct costs plus general conditions, and covers the contractor's bond, insurance, site office overheads and profit.

Unless identified otherwise, the cost of such items as overtime, shift premiums and construction phasing are not included in the line item unit price.

This cost estimate is based on standard industry practice, professional experience and knowledge of the local construction market costs. TBD Consultants have no control over the material and labor costs, contractors' methods of establishing prices or the market and bidding conditions at the time of bid. Therefore TBD Consultants do not guarantee that the bids received will not vary from this cost estimate.

CONTINGENCY

Design Contingency 10%

The Design Contingency is carried to cover scope that lacks definition and scope that is *anticipated* to be added to the Design. As the Design becomes more complete the Design Contingency will reduce.

Construction Contingency 0% *Carried else where in owners budget*

The Construction Contingency is carried to cover the unforeseen during construction execution and Risks that do not currently have mitigation plans. As Risks are mitigated, Construction Contingency can be reduced, but should not be eliminated.

BASIS OF ESTIMATE

ESCALATION

Escalation has been added to the estimate to reflect the anticipated increases in labor and materials up until the mid point of construction. Escalation is calculated as being compound.

Escalation Per Year

<u>Year</u>	<u>Escalation</u>
2014	5.00%
2015	5.00%
2016	5.00%

This calculation does not account for adverse bidding conditions and a separate Bid Contingency should be carried if there are limited qualified bidders or if a market research study indicates.

EXCLUSIONS

- Land acquisition, feasibility, and financing costs
- All Owner soft costs
- All professional fees and insurance
- Construction Manager Costs
- Site or existing condition survey investigation costs, including determination of subsoil conditions
- Hazardous materials inspection costs
- AV networks, equipment or software (unless identified otherwise)
- Primary and secondary electrical cabling, master clock system
- Third party MEP commissioning
- Rock excavation
- Utility company back charges, including work required off-site
- Overtime, 2nd shift and lost productivity premiums
- Construction or occupancy phasing
- Owners Construction Contingency for scope changes and market conditions at time of bid
- Owner supplied and installed furniture, fixtures and equipment
- Items identified in the design as Not In Contract (NIC)
- Work to City streets and sidewalks, [except as noted in this estimate]
- Permits

BASIS OF ESTIMATE

ITEMS THAT MAY AFFECT THIS ESTIMATE

Such items include, but are not limited to the following:

- Modifications to the scope of work subsequent to the preparation of this estimate
- Unforeseen subsurface conditions
- Special requirements for site access, off-hour work or phasing activities
- Restrictive technical specifications, excessive contract or non-competitive bid conditions
- Sole source specifications for materials or products
- Bid approvals delayed beyond the anticipated project schedule

GENERAL ACKNOWLEDGEMENTS

Requests for modifications of any apparent errors or omissions in this document must be made to tbd Consultants within ten (10) working days of receipt of this estimate. Otherwise it will be understood that the contents have been concurred with and accepted.

Since tbd Consultants has no control over the cost of labor, materials, equipment, the contractors method of estimating prices, competitive bidding or market conditions, the opinion of probable construction cost provided for herein is made on our best professional judgment.

KEY CRITERIA

Added Surface Parking

AREA TABULATION

	Perimeter	Height	Comment
Site Area	21,000		
			Roof Level
Subtotal	0	0 LF	0.0 LF

BUILDING CRITERIA

Site Area 21,000 **SF** net bulding 1,000 SF
 Parking Stalls **68 EA**
 Space per stall **309 SF**

CONSTRUCTION SCHEDULE

Construction Start Date 0-Jan-00 Construction End Date
 Mid-date of Construction 0-Jan-00 Construction Duration
 Escalation Period

OVERALL SUMMARY **Added Surface Parking**

	GROSS FLOOR AREA	COST (\$/SF)	COST (\$'s)	Cost/Stall \$/Stall
Added Surface Parking (68 stalls)	21,000	\$38	\$802,491	\$11,801
Moving cost	NA			
Hazmat abatement	NA		NA	
Soft costs	20% of direct cost		\$200,623	\$ 2,950
FFE				
Construction Contingency	5% of direct cost		\$40,125	\$ 590
TOTAL including soft and hard cost			\$1,043,239	\$ 15,342

Added Surface Parking

UNIFORMAT II SUMMARY

GSF : 21,000

SECTION	%	SUB TOTAL	TOTAL	\$/SF	COMMENTS
F SPECIAL CONSTRUCTION + DEMOLITION					
10					
20					SELECTIVE BUILDING DEMOLITION
G BUILDING SITEWORK					
	100.0%		554,140		
10	19.1%	106,100		5.05	SITE PREPARATION
20	41.7%	231,040		11.00	SITE IMPROVEMENTS
30	0.5%	3,000		0.14	SITE MECHANICAL UTILITIES
40	4.5%	25,000		1.19	SITE ELECTRICAL UTILITIES
50	34.1%	189,000		9.00	OTHER SITE CONSTRUCTION
DIRECT COSTS			554,140	26.39	
	4.0%		22,166	1.06	SITE REQUIREMENTS
	4.0%		22,166	1.06	JOBSITE MANAGEMENT
ESTIMATE SUB-TOTAL			598,472	28.50	
	2.0%		11,969	0.57	INSURANCE + BONDING
	4.0%		23,939	1.14	FEE
ESTIMATE SUB-TOTAL			634,380	30.21	
	10.0%		63,438	3.02	DESIGN CONTINGENCY
					CONSTRUCTION CONTINGENCY
					MARKET CONDITIONS FACTOR
ESTIMATE SUB-TOTAL			697,818	33.23	Carried elsewhere N/A
	15.00%		104,673	4.98	ESCALATION 3 YEARS TO MIDPOINT
ESTIMATE TOTAL			802,491	38.21	

ESTIMATE DETAIL Added Surface Parking GSF : 21,000

REF	DESCRIPTION	QUANTITY	UoM	UNIT RATE	TOTAL	COMMENTS
1						
2	A10					
3						
4	F20					
5						
6	SELECTIVE BUILDING DEMOLITION					
7						
8	No work in this section					
9						
10	SELECTIVE BUILDING DEMOLITION		F20			\$0 / SF
11						
12	G10					
13						
14	SITE PREPARATION					
15						
16	Site Earthwork					
17	Clear and grub site	21,000	SF	0.20	4,200	
18	Cut/fill	21,000	SF	1.50	31,500	
19	Rough and fine grading	21,000	SF	0.40	8,400	
20	Remove surplus offsite	1,500	CY	30.00	45,000	
21	Erosion control	1	LS	10,000.00	10,000	
22	Erosion control	2	MO	1,000.00	2,000	
23						
24	Site Demolition		NA			
25	Tree removal	1	LS	5,000.00	5,000	
26						
27	Hazardous Waste Remediation					
28	Excluded					
29						
30	SITE PREPARATION		G10		106,100	\$5.05 / SF
31						
32	G20					
33						
34	SITE IMPROVEMENTS					
35						
36						
37						
38						
39	Hardscaped areas					
40	DG paving	21,000	SF	5.00	105,000	pervious pavement
41	Concrete curbs	900	LF	27.00	24,300	
42	Storm drainage	21,000	SF	2.00	42,000	
43	Repairs to adjacent road at curb cuts	1	LS	10,000.00	10,000	
44						
45						
46	Markings & Signage					
47	Site signage	1	LS	4,000.00	4,000	
48	Miscellaneous striping	1	LS	3,500.00	3,500	
49						
50	Site Furnishings					
51	Wheel stops	68	EA	55.00	3,740	
52	Bollards		NA			
53	Fencing and gates		NA			
54						
55	Landscaping					
56	Ground cover and landscaping ,trees- repairs	1	LS	35,000.00	35,000	
57	Includes the following					
58	Ground preparation					
59	Shrubs and ground cover					
60	Trees					
61						
62	Irrigation Systems repairs	1	LS	3,500.00	3,500	
63						
64	SITE IMPROVEMENTS		G20		231,040	\$11 / SF

ESTIMATE DETAIL		Added Surface Parking			GSF :	21,000
REF	DESCRIPTION	QUANTITY	UoM	UNIT RATE	TOTAL	COMMENTS
65						
66	G30					
67						
68	SITE MECHANICAL UTILITIES					
69						
70	Allow for utility conflicts	1	LS	3,000.00	3,000	
71						
72	SITE MECHANICAL UTILITIES		G30		3,000	\$0.14 / SF
73						
74	G40					
75						
76	SITE ELECTRICAL UTILITIES					
77						
78	Site Electrical site lighting	1	LS	25,000.00	25,000	Allowance
79						
90	SITE ELECTRICAL UTILITIES		G40		25,000	\$1.19 / SF
91						
92	G50					
93						
94	OTHER SITE CONSTRUCTION					
95						
96	Removal and replacement with grass/landscaping	21,000	SF	9.00	189,000	
97						
98	OTHER SITE CONSTRUCTION		G50		189,000	\$9 / SF

This page intentionally left blank.

APPENDIX A - 20

CCMP Sitework for City Hall (TBD, May 15, 2015)

Cupertino Civic Center Masterplan

Sitework To City Hall

Cupertino CA

Based on Assumed Area Adjoining New City Hall

Concept Cost Estimate

May 15, 2015

Prepared By:



111 Pine Street, Suite 1315
San Francisco, CA 94111
415.981.9430 phone (main)
415.981.9434 facsimile
www.tbdconsultants.com

Prepared for:

Perkins Will
2 Bryant Street
San Francisco, CA

TABLE OF CONTENTS

SECTION	PAGE NUMBER
BASIS OF ESTIMATE	3
KEY CRITERIA	6
OVERALL SUMMARY	7
UNIFORMAT II SUMMARY	8
ESTIMATE DETAIL	9

BASIS OF ESTIMATE

PROJECT DESCRIPTION

This project involves sitework above podium and adjoining impacted areas

REFERENCE DOCUMENTATION

This Construction Cost Estimate was produced from the following documentation by International Parking Design and engineering changes occurring subsequent to the issue of these documents have not been incorporated in this estimate.

Document

- Sitework based on assumed site area - adjoining building/parking only
-

BASIS FOR PRICING

This estimate reflects the fair construction value for this project and should not be construed as a prediction of low bid. Prices are based on local prevailing wage construction costs at the time the estimate was prepared. Pricing assumes a procurement process with competitive bidding for all sub-trades of the construction work, which is to mean a minimum of 3 bids for all subcontractors and materials/equipment suppliers. If fewer bids are solicited or received, prices can be expected to be higher.

Subcontractor's markups have been included in each line item unit price. Markups cover the cost of field overhead, home office overhead and subcontractor's profit. Subcontractor's markups typically range from 15% to 25% of the unit price depending on market conditions.

General Contractor's/Construction Manager's Site Requirement costs are calculated on a percentage basis. General Contractor's/Construction Manager's Jobsite Management costs are also calculated on a percentage basis.

General Contractor's/Construction Manager's overhead and fees are based on a percentage of the total direct costs plus general conditions, and covers the contractor's bond, insurance, site office overheads and profit.

Unless identified otherwise, the cost of such items as overtime, shift premiums and construction phasing are not included in the line item unit price.

This cost estimate is based on standard industry practice, professional experience and knowledge of the local construction market costs. TBD Consultants have no control over the material and labor costs, contractors' methods of establishing prices or the market and bidding conditions at the time of bid. Therefore TBD Consultants do not guarantee that the bids received will not vary from this cost estimate.

CONTINGENCY

Design Contingency 10%

The Design Contingency is carried to cover scope that lacks definition and scope that is *anticipated* to be added to the Design. As the Design becomes more complete the Design Contingency will reduce.

Construction Contingency 10% *Carried else where in owners budget*

The Construction Contingency is carried to cover the unforeseen during construction execution and Risks that do not currently have mitigation plans. As Risks are mitigated, Construction Contingency can be reduced, but should not be eliminated.

BASIS OF ESTIMATE

ESCALATION

Escalation has been added to the estimate to reflect the anticipated increases in labor and materials up until the mid point of construction. Escalation is calculated as being compound.

Escalation Per Year

<u>Year</u>	<u>Escalation</u>
2014	5.00%
2015	5.00%
2016	5.00%

This calculation does not account for adverse bidding conditions and a separate Bid Contingency should be carried if there are limited qualified bidders or if a market research study indicates.

EXCLUSIONS

- Land acquisition, feasibility, and financing costs
- All Owner soft costs
- All professional fees and insurance
- Construction Manager Costs
- Site or existing condition survey investigation costs, including determination of subsoil conditions
- Hazardous materials inspection costs
- AV networks, equipment or software (unless identified otherwise)
- Primary and secondary electrical cabling, master clock system
- Third party MEP commissioning
- Rock excavation
- Utility company back charges, including work required off-site
- Overtime, 2nd shift and lost productivity premiums
- Construction or occupancy phasing
- Owners Construction Contingency for scope changes and market conditions at time of bid
- Owner supplied and installed furniture, fixtures and equipment
- Items identified in the design as Not In Contract (NIC)
- Work to City streets and sidewalks, [except as noted in this estimate]
- Permits

BASIS OF ESTIMATE

ITEMS THAT MAY AFFECT THIS ESTIMATE

Such items include, but are not limited to the following:

- Modifications to the scope of work subsequent to the preparation of this estimate
- Unforeseen subsurface conditions
- Special requirements for site access, off-hour work or phasing activities
- Restrictive technical specifications, excessive contract or non-competitive bid conditions
- Sole source specifications for materials or products
- Bid approvals delayed beyond the anticipated project schedule

GENERAL ACKNOWLEDGEMENTS

Requests for modifications of any apparent errors or omissions in this document must be made to tbd Consultants within ten (10) working days of receipt of this estimate. Otherwise it will be understood that the contents have been concurred with and accepted.

Since tbd Consultants has no control over the cost of labor, materials, equipment, the contractors method of estimating prices, competitive bidding or market conditions, the opinion of probable construction cost provided for herein is made on our best professional judgment.

KEY CRITERIA Sitework To City Hall

AREA TABULATION

	Enclosed	Perimeter	Height	Comment
Basement		900	11.3	

Roof Level

Subtotal	0	900 LF	11.3 LF	
-----------------	----------	---------------	----------------	--

BUILDING CRITERIA

Site Area	58,750 SF	net bulding	38,750 SF
Parking Stalls	118 EA		
Space per stall	0 SF		

CONSTRUCTION SCHEDULE

Construction Start Date	0-Jan-00	Construction End Date	
Mid-date of Construction	0-Jan-00	Construction Duration	
Escalation Period			

OVERALL SUMMARY

Sitework To City Hall

	GROSS FLOOR AREA	COST (\$/SF)	COST (\$'s)
Sitework To City Hall	58,750	\$67	\$3,962,472
Moving cost	NA		
Hazmat abatement	NA		NA
Soft costs	20% of direct cost		\$990,618
FFE			
Construction Contingency	10% of direct cost		\$396,247
TOTAL including soft and hard cost			\$5,349,337

Sitework To City Hall

UNIFORMAT II SUMMARY

GSF : 58,750

SECTION	%	SUB TOTAL	TOTAL	\$/SF	COMMENTS
F SPECIAL CONSTRUCTION + DEMOLITION					
10					
20					
G BUILDING SITEWORK					
	100.0%		2,736,188		
10	10.3%	280,500		4.77	
20	76.2%	2,085,688		35.50	
30	8.0%	220,000		3.74	
40	5.5%	150,000		2.55	
50					
DIRECT COSTS			2,736,188	46.57	
SITE REQUIREMENTS	4.0%	109,448		1.86	
JOBSITE MANAGEMENT	4.0%	109,448		1.86	
ESTIMATE SUB-TOTAL			2,955,084	50.30	
INSURANCE + BONDING	2.0%	59,102		1.01	
FEE	4.0%	118,203		2.01	
ESTIMATE SUB-TOTAL			3,132,389	53.32	
DESIGN CONTINGENCY	10.0%	313,239		5.33	
CONSTRUCTION CONTINGENCY					Carried elsewhere
MARKET CONDITIONS FACTOR					N/A
ESTIMATE SUB-TOTAL			3,445,628	58.65	
ESCALATION 3 YEARS TO MIDPOINT	15.00%	516,844		8.80	
ESTIMATE TOTAL			3,962,472	67.45	

ESTIMATE DETAIL Sitework To City Hall GSF : 58,750

REF	DESCRIPTION	QUANTITY	UoM	UNIT RATE	TOTAL	COMMENTS
1						
2	A10					
3						
4	F20					
5						
6	SELECTIVE BUILDING DEMOLITION					
7						
8	No work in this section					
9						
10	SELECTIVE BUILDING DEMOLITION		F20			\$0 / SF
11						
12	G10					
13						
14	SITE PREPARATION					
15						
16	Site Earthwork					
17	Clear and grub site	58,750	SF	0.40	23,500	
18	Cut/fill	58,750	SF	2.00	117,500	
19	Rough and fine grading	58,750	SF	0.40	23,500	
20	Erosion control	1	LS	30,000.00	30,000	
21	Erosion control	9	MO	4,000.00	36,000	
22						
23	Site Demolition	1	LS	50,000.00	50,000	Excl building
24						
25	Hazardous Waste Remediation					
26	Excluded					
27						
28	SITE PREPARATION		G10		280,500	\$4.77 / SF
29						
30	G20					
31						
32	SITE IMPROVEMENTS					
33						
34	Podium					
35	Topping slab and waterproofing	23,500	SF	40.00	940,000	
36						
37	Hardscaped areas	19,375	SF	30.00	581,250	
38	Repairs to adjacent road	1	LS	50,000.00	50,000	
39						
40						
41	Markings & Signage					
42	Site signage	1	LS	35,000.00	35,000	
43	Miscellaneous striping	1	LS	3,500.00	3,500	
44						
45	Site Furnishings	1	LS	40,000.00	40,000	
46	Bollards					
47	Seating elements					
48	Bike racks					
49	Fencing and gates					
50						
51	Landscaping					
52	Groundnd cover and landscaping	19,375	SF	20.00	387,500	
53						
54	Ground preparation					
55	Shrubs and ground cover					
56	Trees					
57						
58	Irrigation Systems	19,375	SF	2.50	48,438	
59						
60	SITE IMPROVEMENTS		G20		2,085,688	\$35.5 / SF

ESTIMATE DETAIL Sitework To City Hall GSF : 58,750

REF	DESCRIPTION	QUANTITY	UoM	UNIT RATE	TOTAL	COMMENTS
61						
62	G30					
63						
64	SITE MECHANICAL UTILITIES					
65						
66	Fire	1	LS	40000.00	40,000	
67	Point of connection					
68	10" dia C900 piping					
69	8" dia					
70	6" dia					
71	Fire hydrant with s/off valve					
72	Fire post indicator valve					
73	Fire department connection					
74	8" dia Double detector assembly valve					
75	Thrust block					
76						
77	Water	1	LS	30,000.00	30,000	
78	Point of connection					
79	4" dia C900 piping					
80	Meters, Valves & specialties					
81						
82	Sanitary Sewer	1	LS	50,000.00	50,000	
83	Remove existing Sanitary sewer					
84	Point of connection					
85	6" dia piping					
86	Manhole					
87	SS Cleanout					
88						
89	Stormwater	1	LS	100,000.00	100,000	
90	Point of connection					
91	12" dia SDR 35 piping					
92	Manhole					
93	Catchbasin / "Christy inlet"					
94	Catchbasin / "Bubbler box"					
95	SD Cleanout					
96	Perforated piping					
97						
98	SITE MECHANICAL UTILITIES		G30		220,000	\$3.74 / SF
99						
100	G40					
101						
102	SITE ELECTRICAL UTILITIES					
103						
104	Site Electrical	1	LS	150,000.00	150,000	
115						
116	SITE ELECTRICAL UTILITIES		G40		150,000	\$2.55 / SF
117						
118	G50					
119						
120	OTHER SITE CONSTRUCTION					
121						
122	No work in this section					
123						
124	OTHER SITE CONSTRUCTION		G50			\$0 / SF

This page intentionally left blank.

APPENDIX A - 21

Cupertino Civic Center Funding Strategy Analysis
(Seifel Consulting, June 23, 2015)



Memorandum

Date June 23, 2015

To: Perkins+Will

From: Seifel Consulting Inc.

Subject: Cupertino Civic Center Funding Strategy Analysis

Perkins+Will retained Seifel Consulting Inc. (Seifel) to provide a funding strategy regarding the proposed improvements to the Civic Center in the City of Cupertino (City) as part of the Civic Center Master Plan process. In collaboration with City staff and Perkins+Will, Seifel evaluated and recommended potential funding sources to implement the Master Plan. As further described in this memorandum, Certificates of Participation (COP) debt financing is proposed to be the primary source of funding—the same funding mechanism as previously used to fund most of the existing Civic Center improvements. As the potential issuance of additional COP debt would become a future obligation of the City's General Fund, this memorandum also presents projections of potential future revenues from new development.

This memorandum summarizes the findings of our analysis and is organized as follows:

- A. Description of Proposed Civic Center Master Plan Improvements
- B. Review of Potential Funding Sources
- C. Potential Public Revenues
- D. Recommended Funding Strategy

The purpose of this memorandum is to inform the Civic Center Master Plan process and to provide general strategic guidance regarding funding options. If the City were to decide to utilize COP financing to help fund the Civic Center improvements, the City would need to engage municipal bond specialists to advise the City on any future municipal debt issuance. Quint Thimmig served as bond counsel for the City's existing COP debt and was interviewed during the preparation of this analysis. Brian Quint of Quint Thimmig is available to provide more specific recommendations regarding the potential issuance of municipal debt and to recommend additional COP bond specialists to assist the City.

A. Description of Proposed Civic Center Master Plan Improvements

The Civic Center serves as an important gathering place for educational, governmental and recreational events for the Cupertino community. Recent planning and construction efforts have more firmly established the Civic Center's importance in the daily life of residents and visitors alike through the completion of the library, community hall and library plaza in 2004. Due to its widespread use and popularity, the Civic Center needs further improvements to meet the City's future needs.

The proposed Civic Center Master Plan includes potential improvements to the following public facilities:

- Improved public access and circulation, including enhanced pedestrian and bicycle infrastructure and expanded parking facilities. (This would significantly improve public access to the Civic Center and enable the City to meet the needs of future growth.)
- New City Hall, featuring underground parking to help alleviate current parking congestion. (A new City Hall would foster new opportunities for civic engagement, improved interface between City Hall and public services, safer conditions for building occupants, innovative and sustainable practices in building design, and new programming uses that would benefit the community.)
- Expansion of the southern side of the existing library to accommodate intensified programming and events. (The library expansion would offer secondary entry and exit points, allowing community facilities to be used during the library's closing hours, and would alleviate pressure on the Community Hall building, which is frequently in use for library programming.)

Based on cost estimates prepared by the Perkins+Will team on the proposed Master Plan design, these facilities are projected to cost approximately \$68.1 million (consisting of \$62.7 million for the public access, parking and new City Hall plus \$5.4 million for the library expansion).

B. Review of Potential Funding Sources

In order to accomplish the Civic Center Master Plan, a variety of funding sources will need to be utilized. In collaboration with City staff and Perkins+Will, Seifel evaluated several potential approaches to funding and developed the following recommendations regarding potential funding options.¹

1. Recommended Funding Sources

Based on a review of City documents and a series of discussions and consultation with City staff, Perkins+Will and Quint Thimmig, four funding sources are recommended as the primary sources to fund the proposed improvements.

a. City General Fund Contributions

The City's General Fund receives revenues from a broad range of sources, with the primary sources being sales tax, transient occupancy tax and property taxes generated by existing and future development. (Projections of potential revenue sources from future development are presented in Section C of this memorandum.) City funding of major improvements are evaluated and allocated during the City's budgeting and capital planning process, which typically includes the designation of specific funding appropriations to specified projects in the City's Capital Improvement Program. If the Master Plan were to be adopted, the City would evaluate its current and projected revenue stream to determine how much funding may be available from the General Fund (either from existing cash or capital reserves). Based on discussions with City staff and the City's prior experience with similar projects, the City is assumed to directly fund about 10 percent (or about \$6.8 million) of anticipated project costs through its Capital Improvement Program, likely spread across two to three fiscal years.

¹ The purpose of this analysis is to inform the Civic Center Master Plan process. The analysis and projections presented in this memorandum are designed to provide the City with general strategic guidance rather than to provide specific recommendations regarding the potential issuance of municipal debt. If the City were to move forward with the potential use of COPs or other municipal debt mechanism to help fund the Civic Center improvements, the City would need to engage municipal bond specialists to advise the City on this bond issuance.

b. Certificates of Participation Financing

Like many cities throughout California, the City of Cupertino utilized Certificates of Participation (COP) as the major source of funding for the 2004 Civic Center improvements, and this same municipal financing tool is recommended to fund the Master Plan improvements.

In summary, the following key steps would need to be undertaken to use this funding source:

- The City would issue additional COP debt secured by lease payments for the proposed Master Plan improvements based on a “site and facility lease.”
- A designated intermediary (the Cupertino Public Facilities Corporation) would lease the property back to the City pursuant to the lease agreement.
- The certificates will be payable solely from (and secured by) these lease payments.
- The lease payment obligations would need to be funded out of City General Fund revenues.
- As the City issued COP debt to fund the existing Civic Center improvements that include the existing City Hall building, the City would need to “substitute” another community asset of equivalent or greater value for the existing City Hall building prior to its demolition.²
- The Quinlan Community Center is a potential community asset that could be substituted for the existing City Hall building, subject to City Council approval.
- Prior to undertaking the issuance of COP debt, the City would need to consult with municipal bond specialists to advise on the structuring of the debt obligations and issuance procedures.

c. Santa Clara County Library

The City of Cupertino has an existing lease with the Santa Clara County Library Joint Powers Authority (County Library), which provides for annual lease payments of \$120,000 per year plus an additional payment tied to the ratio of assessed value in Cupertino relative to countywide growth. The existing lease is scheduled to end in 2018, but the County Library has the option to extend this lease for another 25 years. Based on information provided by City staff, these lease payments do not fully cover the City’s annual operation and maintenance costs for the library and thus are not currently a source of revenue for capital improvements.

Given that the library expansion represents a substantial portion of the proposed Civic Center improvements, the County Library could be approached to provide additional funding, either through the potential renegotiation of the County Library lease agreement or through an appropriation of funds from Santa Clara County or the County Library. According to information gathered from the County Auditor, the County Library District currently receives an allocation of property tax revenues from bond override payments equal to 2.4 percent of 1 percent of assessed value on all property within the City of Cupertino. These bond override revenues are in addition to funding that the County receives as part of its share of basic property tax revenues generated in Cupertino.

d. Private Funds

The existing furniture and equipment in the Cupertino Library was primarily funded through private donations by a local non-profit corporation (Friends of the Cupertino Library). Private donations could

² The City of Cupertino issued COP debt in 2002 in order to fund the existing Civic Center improvements and refinanced this COP debt in 2012 to achieve a significant reduction in debt service payments due to lowered bond interest rates. (The 2012 COP bond principal amount was \$44 million with a 2.8 percent interest rate through FY 2030/31 and annual debt service payments of \$3.2 million in FY 2014/15.) The substitution of assets is allowable under the 2012 COP refinancing but would require the advice and assistance of bond counsel to accomplish this substitution.

provide a significant source of funding for the furniture and equipment in the Library expansion and new City Hall, as well as improvements to the public plaza.

2. Other Funding Sources Not Considered Likely

The following funding sources were evaluated during the course of this study but are not considered to be likely sources of revenues for the proposed improvements:

- **Development Impact Fees**– The City of Cupertino does not currently have a development impact fee program that could be used to fund these types of facilities. The City would need to undertake a series of analyses and procedures to adopt such a fee.
- **Voter-Approved Debt**– The City of Cupertino could potentially utilize one of several voter approved financing mechanisms to help fund the Civic Center, such as General Obligation bonds, a parcel tax, or Mello-Roos Community Facilities District. California local governments must obtain the approval of local voters to raise taxes to provide this type of funding. Given that the City would want to specifically dedicate this funding for the Civic Center, two-thirds of the City’s voters would likely need to vote positively to approve this type of funding.
- **Federal and State Programs**– No major Federal or State funding programs currently offer major grant programs that could be used to fund the proposed improvements.
- **Public Private Partnerships**– The use of Public Private Partnerships is not a likely source of private funding. Given that no private business or real estate opportunities are proposed and the relatively small scale of the proposed public improvements, this project would not likely attract significant private investment in exchange for development rights or other private participation opportunities.

C. Potential Public Revenues

Given that the primary source of proposed funding would consist of Certificates of Participation that would become an obligation of the City’s General Fund (potentially supplemented through contributions for the Library), Seifel evaluated current and future public revenues that could be available.

1. City of Cupertino Existing General Fund Revenues

According to the City’s FY 2014/15 budget, the City generates about \$56 million in General Fund revenues. The City’s top three revenue sources are sales tax (32 percent), property tax (27 percent) and transient occupancy tax (8 percent). A variety of other revenue sources contribute the remaining 33 percent.

Table 1
FY 2014/15 General Fund Revenues

	Total	As % of Total GF Revenues
General Fund (GF) Revenues		
Sales Tax	\$18,288,000	32%
Property Tax	\$15,067,000	27%
Transient Occupancy Tax (TOT)	\$4,510,000	8%
Utility Tax	\$3,100,000	6%
<u>Other Revenue Sources</u>	<u>\$15,347,500</u>	<u>27%</u>
Total	\$56,312,500	100%

Source: City of Cupertino

2. Existing General Fund Debt Service Obligations

According to the City's FY 2014/15 budget, the City's annual debt service obligation for the existing COP is annually \$3.2 million, which is approximately 6 percent of total General Fund revenues. The COP is the City's only major debt obligation.

Figure 1
FY 2014/15 General Fund Revenues

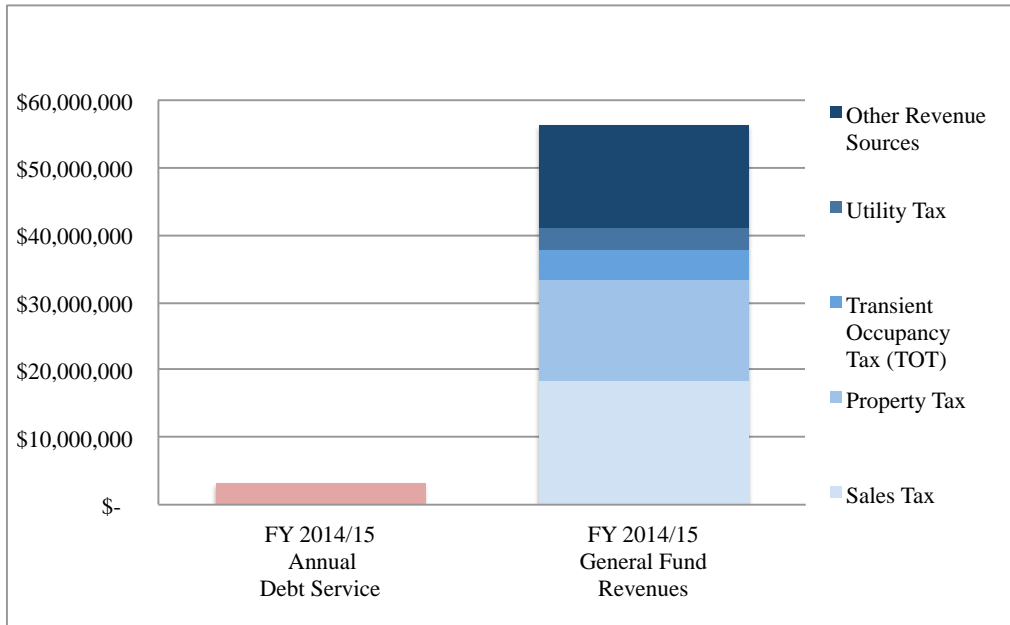

3. Projected Revenues from New Development

The City's General Fund revenue is projected to increase as new development occurs. According to City staff, four major new developments are underway: Apple's new campus, two new hotel developments (Hyatt House Extended-Stay and Marriott Residence Inn at the Vallco area) and the Main Street retail development. These new developments are projected to generate additional property tax revenue, sales tax revenue, transit occupancy tax and other revenues, as summarized in Table 2.³ Their combined revenue is projected to increase General Fund revenue by about 10 percent. (Assumptions and methodology for revenue projections are further explained in the following section.)

³ While Seifel has made extensive efforts to substantiate this information, Seifel does not guarantee the accuracy of third party data and assumes no responsibility for inaccuracies in the provided information or analysis. Any estimated revenue projections are based on the best available project-specific data as well as the experiences of similar projects. They are not intended to be projections of the future for the specific project, and no warranty or representation is made that any of the estimates or projections will actually materialize.

Table 2
Projected General Fund Revenues with New Development

General Fund Revenues	Total
FY 2014/15 General Fund Revenues	
Sales Tax	\$18,288,000
Property Tax	\$15,067,000
Transient Occupancy Tax (TOT)	\$4,510,000
Utility Tax	\$3,100,000
<u>Other Revenue Sources</u>	<u>\$15,347,500</u>
Subtotal	\$56,312,500
Projected Revenues From New Development	
Apple Campus (Net Fiscal Impact) ^a	\$3,200,000
Hyatt House Extended-Stay	\$928,000
Marriott Residence Inn at Vallco Area	\$1,128,000
<u>Main Street Retail</u>	<u>\$542,000</u>
Subtotal	\$5,798,000
<i>Projected GF Revenue Increase</i>	<i>10%</i>
Total Projected General Fund Revenues	\$62,110,500

a. Per "Economic and Fiscal Impacts Generated by Apple in Cupertino – Current Facilities and Apple Campus 2." Prepared by Keyser Marston Associates for Apple Inc. May 2013.
Source: City of Cupertino, Keyser Marston Associates, Seifel Consulting Inc.

a. Additional Revenues from Apple New Campus

The development of Apple's new campus would generate additional revenues to the General Fund. Per the economic and fiscal impact analysis performed by Keyser Marston Associates (KMA) for Apple in May 2013, Apple's new campus is projected to generate about \$1.72 million in property tax revenue, \$0.9 million in sales tax revenue, \$0.7 million in TOT, and \$0.5 million in other General Fund revenues, representing a \$3.8 million increase in General Fund revenue.⁴

Per KMA's analysis, the fiscal cost (associated with Apple's new campus) to the General Fund is approximately \$0.6 million. Thus, the net fiscal impact on the City's General Fund from Apple's new campus is projected to be about \$3.2 million.

b. Property Taxes

New development within Cupertino will result in the generation of additional property tax revenue from growth in assessed value from the four major new developments. The growth in assessed value from these four developments is projected to be approximately \$2.8 billion.⁵ Additional property taxes generated from this new development will be allocated to the City General Fund (based on 5.6 percent of the basic 1-percent property tax rate) and the County Library (2.4 percent of the property tax bond override).

⁴ "Economic and Fiscal Impacts Generated by Apple in Cupertino–Current Facilities and Apple Campus 2." Keyser Marston Associates. May 2013.

⁵ As described previously, these developments consist of the Apple Campus, Hyatt House-Extended Stay, Marriott Residence Inn, and Main Street Retail.

Future annual property taxes are projected to be \$1.8 million to the City General Fund and about \$0.8 million to the Library District, as shown in Table 3.⁶

Table 3
Projected Property Tax Revenues

	Incremental Assessed Value	Property Tax Revenues	
		City General Fund 5.6%	Library ^a 2.4%
Apple Campus	\$2,700,000,000	\$1,720,000	\$737,000
Hyatt House Extended-Stay ^b	\$22,000,000	\$12,000	\$5,000
Marriott Residence Inn ^b	\$27,000,000	\$15,000	\$6,000
<u>Main Street Retail^c</u>	<u>\$39,000,000</u>	<u>\$22,000</u>	<u>\$9,000</u>
Total	\$2,788,000,000	\$1,769,000	\$757,000

- a. According to the Santa Clara County tax rate records, the County Library District currently receives an allocation of property tax revenues from bond override payments equal to 2.4 percent of 1 percent of assessed value on all property within the City of Cupertino. These bond override revenues are in addition to funding that the County receives as part of its share of basic property tax revenues generated in Cupertino.
- b. Incremental growth in assessed value for hotel at \$150,000 per hotel room, assuming hotels built on vacant land.
- c. Incremental growth in assessed value for retail at \$300 per square feet, assuming the retail is built on partially developed property.

Source: City of Cupertino, Keyser Marston Associates, Seifel Consulting Inc.

c. Transient Occupancy Tax

The two new hotel developments would generate Transient Occupancy Tax (TOT) revenues based on the City's current 12 percent TOT rate on hotel and motel room revenues. The Hyatt House Extended-Stay is projected to generate annual TOT revenues of about \$900,000 while the Marriott Residence Inn would generate about \$1.1 million (see Table 4).⁷ In addition, as the Apple Campus is built out, it would generate significant TOT revenues for the City from corporate demand for lodging in Cupertino.

Table 4
Projected Transit Occupancy Tax Revenues

	Hyatt House Extended-Stay	Marriott Residence Inn
Number of Rooms	148	180
Occupancy Rates	70%	70%
Room Charge	\$200	\$200
<u>City's TOT Rate</u>	<u>12%</u>	<u>12%</u>
Projected Annual TOT Revenues	\$908,000	\$1,104,000

Source: City of Cupertino, Seifel Consulting Inc.

⁶ Projections of incremental property tax revenue to the City General Fund and the County Library is calculated as the incremental assessed value of a property, multiplied by 1 percent, multiplied by the property tax share.

⁷ Based on an average projected room rate (\$200) and occupancy rate (70 percent) for comparable facilities and the number of planned rooms (148 rooms for Hyatt House Extended-Stay; 180 rooms for Marriott Residence Inn).

d. **Sales Tax Revenue**

The City receives 1 percent of taxable retail sales that occur within the City. The two hotel developments are assumed to generate retail sales tax in addition to TOT. Guests at these hotels are conservatively estimated to spend about \$20 per day on taxable retail expenditures in Cupertino (10 percent of average room revenues). Sales tax revenues for Hyatt House Extended-Stay and Marriott Residence Inn are projected to total about \$17,000, as shown in Table 5. Annual sales tax revenues from Main Street Retail are projected to total about \$520,000,⁸ as summarized in Table 6.

Table 5
Sales Tax Revenues from Hotel Developments

	Hyatt House Extended-Stay	Marriott Residence Inn
Estimated Annual Room Charge	\$7,563,000	\$9,198,000
Taxable Retail Sales % as of Room Charge	10%	10%
Taxable Retail Sales	\$756,300	\$919,800
<u>City Sales Tax Rate</u>	<u>1%</u>	<u>1%</u>
Projected Annual Sales Tax Revenues	\$8,000	\$9,000

Source: City of Cupertino, Seifel Consulting Inc.

Table 6
Sales Tax Revenues from Main Street Retail

	Assumptions
Retail Space	130,000 Sq. Ft.
Taxable Retail Sales	\$400 per Sq. Ft.
<u>City Sales Tax Rate</u>	<u>1% of Taxable Sales</u>
Projected Annual Sales Tax Revenues	\$520,000

Source: City of Cupertino, Seifel Consulting Inc.

e. **Summary of Future Revenues**

In summary, these four major new developments are projected to generate about \$6.4 million in additional revenues to the City’s General Fund from property tax, sales tax, TOT and other revenues, as summarized in Table 7.

Table 7
Future General Fund Revenues from New Development

New Development	Property Tax	Sales Tax	TOT	Other	Total
Apple Campus (Total Revenues)	\$1,720,000	\$900,000	\$703,000	\$477,000	\$3,800,000
Hyatt House Extended-Stay	\$12,000	\$8,000	\$908,000	Not Estimated	\$928,000
Marriott Residence Inn at Vallco Area	\$15,000	\$9,000	\$1,104,000	Not Estimated	\$1,128,000
<u>Main Street Retail</u>	<u>\$22,000</u>	<u>\$520,000</u>	<u>Not Estimated</u>	<u>Not Estimated</u>	<u>\$542,000</u>
Total	\$1,769,000	\$1,437,000	\$2,715,000	\$477,000	\$6,398,000

Source: City of Cupertino, Keyser Marston Associates, Seifel Consulting Inc.

⁸ Based on \$400 per sq. ft. of taxable sales for the 130,000 sq. ft. retail development.

D. Recommended Funding Strategy

As described earlier, the proposed Master Plan improvements are anticipated to cost about \$68.1 million, and the City could primarily fund these improvements through a combination of direct contributions from the City's Capital Improvement Program revenues and through the issuance of new COP debt.⁹ The City could raise additional funding from private donations to help fund the public spaces and/or furnishings, fixtures and equipment (or FF&E) from local non-profit organizations. In particular, the FF&E for the library expansion could be funded through fundraising by the Friends of the Cupertino Library, just as when the library was built. In addition, the County Library District could be asked to potentially increase its lease revenue payments and/or directly contribute to the library expansion given the large amount of future property tax revenues anticipated from new development.

Based on discussions with City staff, the City is anticipated to directly fund about 10 percent (or \$6.8 million) of total project costs through its Capital Improvement Program over a two to three year period. This level of General Fund contribution could be lowered or reimbursed from other resources, such as private donations or County Library revenues.

Assuming that \$6.8 million of project costs are directly funded, the net project costs to be funded by a new COP would total \$61.3 million. Annual debt service on a new COP is projected to be about \$4.0 million annually given the City's excellent financial position and credit rating.¹⁰ Given projected future General Fund revenues of \$62 million, annual new COP debt service payments of \$4.0 million would represent approximately 6 percent of General Fund revenues. (See Table 8.)

Based on the fiscal revenue projections described in this report, anticipated growth in General Fund revenues from new development would likely more than offset this additional debt burden, as shown in Figure 2. As demonstrated in this report, this recommended funding strategy represents a reasonable approach to funding the proposed Civic Center Master Plan improvements.

⁹ This analysis also recommends that the City maintain its existing 2012 COP but substitute Quinlan Community Center for the existing City Hall building.

¹⁰ According to specialists in municipal COP debt issuances, an interest rate of 4.5 percent is a fairly conservative assumption, particularly given that the City's 2012 COP debt received a favorable 2.8 percent interest rate.

Table 8
Potential Funding Structure for Civic Center Project

Project Costs / Funding Sources	Amount
New City Hall Project Costs	\$62,700,000
Library Expansion	\$5,400,000
<u>Less: City Contribution (10% of Costs)</u>	<u>(\$6,800,000)</u>
Net Costs To Be Funded by New COP	\$61,300,000
New COP	Assumptions
Bond Proceeds	\$61,300,000
<u>Bond Reserve / Issuance Cost</u>	<u>\$4,600,000</u>
Bond Principal Amount	\$65,900,000
Debt Service	
Term	30 Years
Interest Rate	4.5 %
Annual Debt Service Payments	\$4,000,000

Source: City of Cupertino, Perkins+Will, TBD Consultants, Project Finance Advisory Ltd., Seifel Consulting Inc.

Figure 2
Comparison of Annual COP Debt Obligations with Projected General Fund Revenues

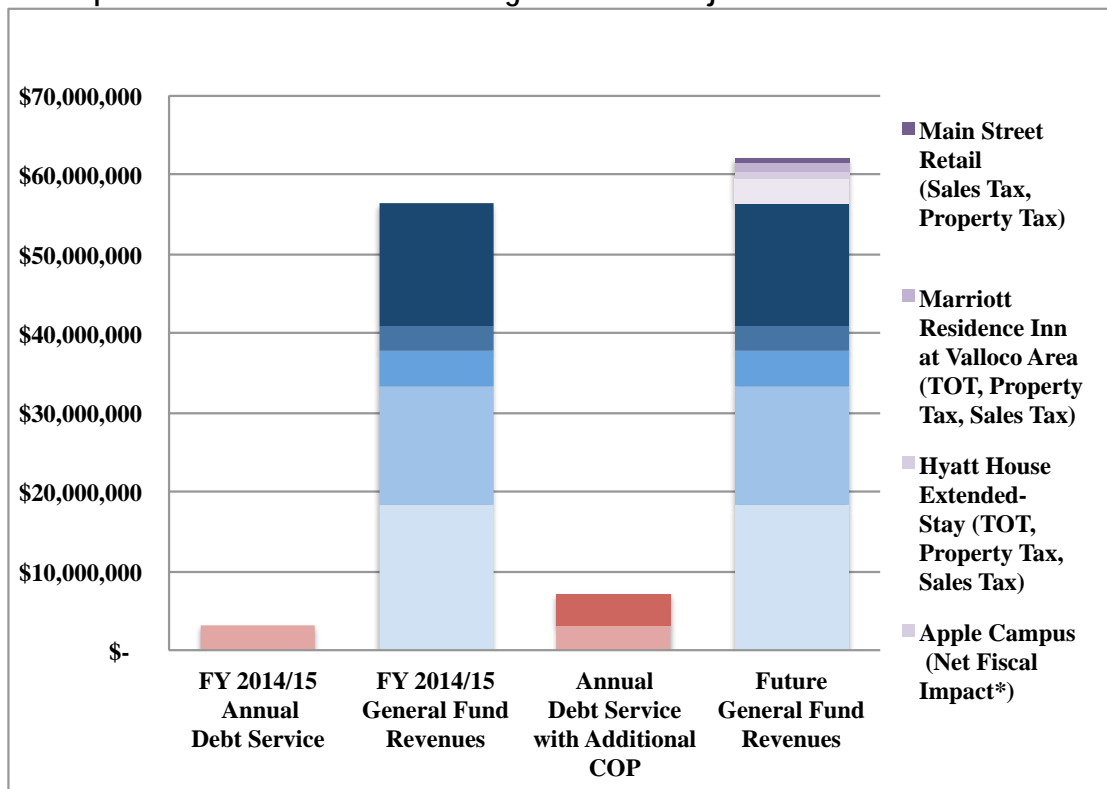



CUPERTINO

10300 Torre Ave
Cupertino, CA 94538
t: 408 777-3200
www.cupertino.gov

**PERKINS
+ WILL**

2 Bryant Street, Suite 300
San Francisco, CA 94105
t: 415.856.3000 f: 415.856.3001
www.perkinswill.com